



S SD9363-EHL-v2

Speed Dome Network Camera

1080p 60 fps • 20x Zoom • 150M IR • IP66 • IK10 •
NEMA 4X • -50°C ~ 55°C

The SD9363-EHL-v2 is the latest professional speed dome camera from VIVOTEK, specifically designed to enhance low light surveillance in large coverage areas. Equipped with 150 M IR illuminators and a 20x optical zoom lens, the SD9363-EHL-v2 provides a superb low light image in the most challenging situations. The SD9363-EHL-v2 also adopts VIVOTEK's Smart IR II technology, which provides smooth vari-angle adjustment of the IR illuminators, allowing broad coverage FOV and highly uniform IR intensity while avoiding hot-spots traditionally associated with IR illumination

The SD9363-EHL-v2 is the PTZ surveillance camera with IR Illumination to utilize H.265 compression technology. When combined with VIVOTEK's Smart Stream II technology users can obtain bandwidth savings of up to 80%* compared to traditional H.264. By combining 1080p full HD resolution with H.265, IR

illuminators, Smart IR II, WDR, and 20x optical zoom, the SD9363-EHL-v2 is able to capture fine details at top-notch quality, 24 hours a day, 7 days a week.

VIVOTEK further strengthened the camera performance with an IP66- and NEMA 4X-rated housing to protect the camera against rain, dust, and corrosion. The SD9363-EHL-v2 has a wide operating temperature range from -50°C to 55°C, ensuring continuous operation under the most extreme weather conditions and hazardous environments. This makes the SD9363-EHL-v2 ideally suited to monitor wide open spaces such as ports, highways, cities, and parking lots where high-level precision is required.

* Depending on scene.

Key Features

- Real-time H.265, H.264 and MJPEG Compression (Triple Codec)
- 60 fps @ 1080p Full HD
- 20x Zoom Lens
- 150M IR with Smart IR II (Vari-Angle IR)
- WDR Pro for Unparalleled Visibility in High Contrast Environments
- Weather-proof IP66, Vandal-proof IK10 and NEMA 4X-rated Housing
- -50°C ~ 55°C Wide Temperature Range for Extreme Weather Conditions (AC 24V/ PoH)
- Smart Stream II to Optimize Bandwidth Efficiency
- EIS (Electronic Image Stabilization) to Control Image Stability
- Power Redundant Supported



Without Smart IR II



With Smart IR II

Technical Specifications

| | | | |
|-------------------------------|-------------------------------------------------------------------------------------|--------------------------|--------------------------------------------------------------------------------------------------------------------------------------------------------------------------------------------------------------------------------------------------------------------------------------------|
| Model | SD9363-EHL-v2 | Dynamic Range | 110 dB |
| System Information | | Video Streaming | Adjustable resolution, quality and bitrate; Smart Stream II |
| CPU | Multimedia SoC (System-on-Chip) | Image Settings | Adjustable image size, quality and bit rate; Time stamp, text overlay, flip & mirror; Configurable brightness, contrast, saturation, sharpness, white balance, exposure control, gain, backlight compensation, privacy masks (Up to 24); Scheduled profile settings, defog, 3DNR, EIS, HLC |
| Flash | 128MB | Audio | |
| RAM | 512MB | Audio Capability | Two-way Audio |
| Camera Features | | Compression | G.711, G.726 |
| Image Sensor | 1/3" Progressive CMOS | Interface | External microphone input External line output |
| Max. Resolution | 1920x1080 | Network | |
| Lens Type | 20x Optical Zoom, Auto Focus | Users | Live viewing for up to 10 clients |
| Focal Length | f = 4.7 ~ 94 mm (20x zoom) | Protocols | IPv4, IPv6, TCP/IP, HTTP, HTTPS, UPnP, RTSP/ RTP/RTCP, IGMP, SMTP, FTP, DHCP, NTP, DNS, DDNS, PPPoE, CoS, QoS, SNMP, 802.1X, UDP, ICMP, ARP, TLS, NTCIP |
| Aperture | F1.6 ~ F3.5 | Interface | 10 Base-T/100 Base-TX Ethernet (RJ-45) *It is highly recommended to use standard CAT5e & CAT6 cables which are compliant with the 3P/ETL standard. |
| Iris type | DC-iris | ONVIF | Supported, specification available at www.onvif.org |
| Field of View | 3° ~ 55° (Horizontal) 2° ~ 33° (Vertical) 3° ~ 63° (Diagonal) | Intelligent Video | |
| Shutter Time | 1/8 sec. to 1/30,000 sec. | Video Motion Detection | Five-window video motion detection |
| WDR Technology | WDR Pro | Auto-Tracking | Auto-tracking on moving object |
| Minimum Illumination | 0.26 Lux @ F1.6 (Color) 0.01 Lux @ F1.6 (B/W) 0 Lux with IR illumination on | Alarm and Event | |
| Day/Night | Removable IR-cut filter for day & night function | Alarm Triggers | Motion detection, manual trigger, digital input, periodical trigger, system boot, recording notification, audio detection, MicroSD card life expectancy |
| Pan Speed | 0.1° ~ 300° / sec. | Alarm Events | Event notification using digital output, HTTP, SMTP, FTP, NAS server and MicroSD card File upload via HTTP, SMTP, FTP, NAS server and MicroSD card |
| Pan Range | 360° endless | General | |
| Tilt Speed | 0.1° ~ 300° / sec. | Connectors | RJ-45 cable connector for Network 10/100 Mbps PoE connection*1 Audio input*1 Audio output*1 AC/DC 24V power input*1 Digital input*4 Digital output*2 RS-485 for PTZ control (PelcoD protocol, Baud rate 2400)*1 |
| Tilt Range | 220° (-110° ~ +110°) | LED Indicator | System power and status indicator |
| Preset Locations | 256 preset locations 128 presets per tour | Power Input | PoH/PoE (95W) AC/DC 24V |
| Pan/Tilt/Zoom Functionalities | 128x digital zoom (4x on IE plug-in, 32x built-in), Auto pan mode, Auto patrol mode | | |
| IR Illuminators | Built-in IR Illuminators up to 150 meters with Smart IR II, IR LED*2 | | |
| On-board Storage | Slot type: MicroSD/SDHC/SDXC card slot Seamless Recording | | |
| Video | | | |
| Compression | H.265, H.264, MJPEG | | |
| Maximum Frame Rate | H.265 & H.264: 60 fps @ 1920x1080 MJPEG: 30 fps @ 1920x1080 | | |
| Maximum Streams | 4 simultaneous streams | | |
| S/N Ratio | 53 dB | | |

Technical Specifications

| | |
|----------------------------|-------------------------------------------------------------------------------------------------------------------------------------------------------------------------------------------------------|
| Power Consumption | PoH/PoE (95W): Max. 70 W (Heater on) Max. 51 W (Heater off) AC/DC 24V: Max. 63 W (Heater on) Max. 45 W (Heater off) |
| Dimensions | 237 x 364 mm |
| Weight | 7.1 kg (with bracket) 5.7 kg (without bracket) |
| Casing | IP66, IK10, NEMA 4X |
| Safety Certifications | CE, FCC Class A, VCCI, C-Tick, NEMA 4X, UL |
| Operating Temperature | Starting Temperature: -40°C ~ 55°C (-40°F ~ 131°F) Working Temperature: -40°C ~ 55°C (-40°F ~ 131°F), DC 24V power input -50°C ~ 55°C (-58°F ~ 131°F), AC 24V/ PoH(95W) power input |
| Humidity | 98% |
| Warranty | 36 months |
| System Requirements | |
| Operating System | Microsoft Windows 8/7 Mac 10.12 (Chrome only) |
| Web Browser | Chrome 58.0 or above Internet Explorer 10/11 |

Other Players

VLC: 1.1.11 or above
Quicktime: 7 or above

Included Accessories







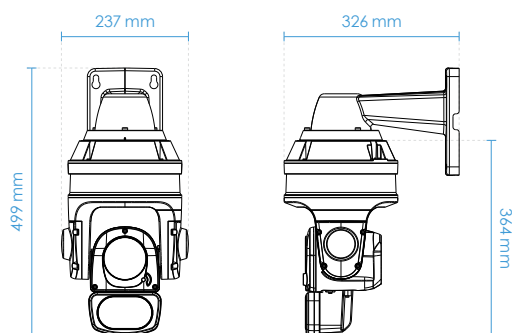







Others

Wall mount bracket, I/O cable, screws, waterproof connectors, terminal blocks, quick installation guide, warranty card, alignment sticker, ground wire, T25 star driver, desiccant bags

Dimensions



Compatible Accessories

| Mounting Kits | | Others | | |
|-----------------------------------------------------------------------------------------------------------------------------|--------------------------------------------------------------------------------------------------------------------------------------------|---------------------------------------------------------------------------------------------------------------------------------------------|--------------------------------------------------------------------------------------------------------------------------------------------------|--------------------------------------------------------------------------------------------------------------------|
|  AM-220 Wall Mount Bracket |  AM-529 Mounting Adapter |  AJ-001 USB Joystick |  AJ-002 USB Joystick |  AO-007 I/O Combo Cable |
| Cabinet | | | | |
|  AT-CAS-001 Cabinet for Speed Dome |  AT-CAB-002 Cabinet for HLG Power Supply |  AT-SUN-002 Sunshield |  AT-SWH-000 Power Safety Kit |  |
| PoE Kit/Power Adapter | | | | |
| 24VAC | | | 24VDC | |
|  AA-341 AC 24V 3.5A Power Adapter |  AA-351 Outdoor Power Box, 24VAC/144W, IP67, IK10 |  AA-352 Outdoor Power Box, 24VAC/144W, IP67, IK10 |  HLG-120H-24 Industrial 24VDC/120W Power Supply, IP67 | |

Compatible Accessories

95W PoH/PoE

| | | | | | | | |
|----------------------------------------------------------------------------------------------------------------------------------------------------|---|--------------------------------------------------------------------------------------------------------------------------------------------------------|-----------------------------------------------------------------------------------------------------------------------------------------------------------------|---|--------------------------------------------------------------------------------------------------------------------------------------------------------|-----------------------------------------------------------------------------------------------------------------------------------------------------------------------------|----------------------------------------------------------------------------------------------------------------------------------------------------------------------------------------------------|
|  AW-IHH-0100 Industrial 1xGE 95W PoH/PoE Injector | + |  HLG-120H-54 Industrial 54VDC/120W Power Supply, IP67 |  AW-IHH-0200 Industrial 1xGE 95W PoH/PoE + 1x SFP GE Switch | + |  HLG-120H-54 Industrial 54VDC/120W Power Supply, IP67 |  AP-GIC-011A-095 1xGE 95W PoH/PoE Injector with Surge Protection 12KV |  AP-GIC-015B-095 Outdoor 1xGE 95W PoH/PoE Injector with Surge Protection 12KV, IP67, IK10 |
|----------------------------------------------------------------------------------------------------------------------------------------------------|---|--------------------------------------------------------------------------------------------------------------------------------------------------------|-----------------------------------------------------------------------------------------------------------------------------------------------------------------|---|--------------------------------------------------------------------------------------------------------------------------------------------------------|-----------------------------------------------------------------------------------------------------------------------------------------------------------------------------|----------------------------------------------------------------------------------------------------------------------------------------------------------------------------------------------------|