

DH-PFA153

Heavy-duty Pole Mount Bracket

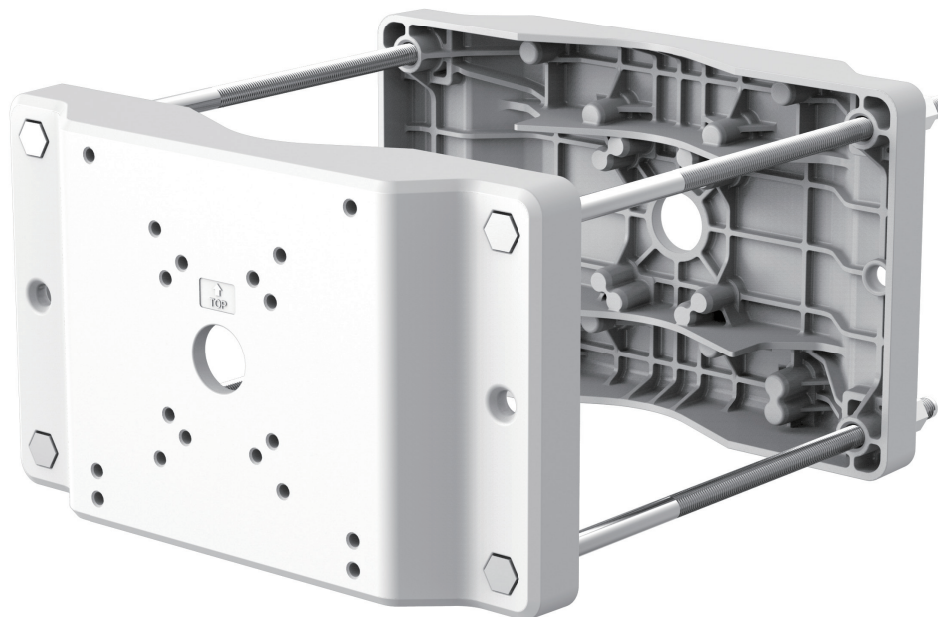

Features

- Material: aluminium & stainless
- High load bearing capacity
- Aesthetic design, double-sided installation
- High compatibility with speed domes , PTZ, outdoor surveillance box, etc.

Technical Specification

Model DH-PFA153

General

Material	Aluminum & stainless
Dimension (WxHxD)	359mmx60mmx213mm (14.14"x2.36"x8.39")
Weight	5kg (11.02lb)
Load Bearing	35kg (77.16lb)
Mast Diameter	φ150~φ300mm(φ5.91"~φ11.81")
Color	White
Operating Temperature	-40 °C ~+60 °C (-40 °F ~+140 °F)
Humidity	0~90% RH
Installation	Pole mount
Applicable Model	Please see "Accessory Selector" on www.dahuasecurity.com

Ordering Information

Type	Part Number	Description
Camera Mount Series	DH-PFA153	Heavy-duty pole mount bracket
	DH-PFA153A	Corrosion-proof heavy-duty pole mount bracket

Dimension(mm/inch)

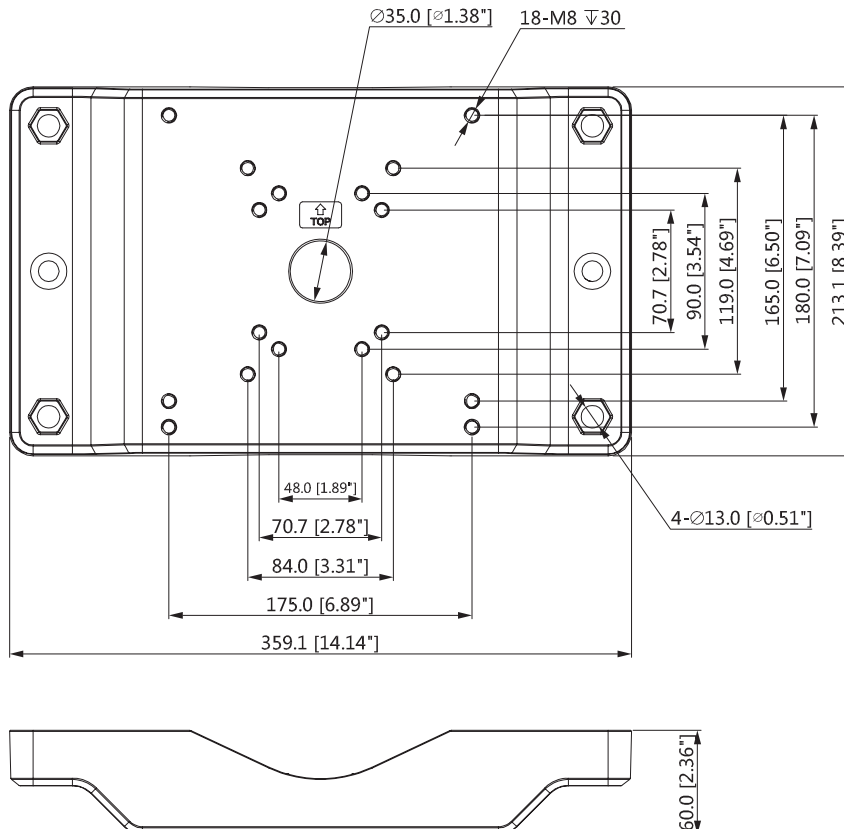

Application

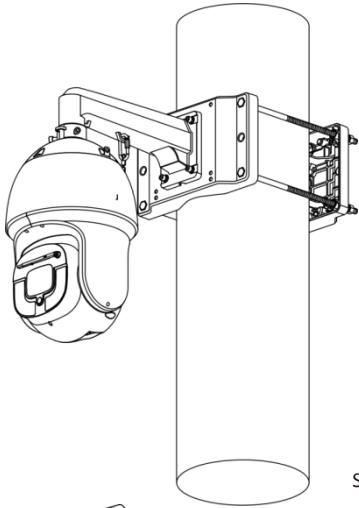

SD10 series PTZ camera

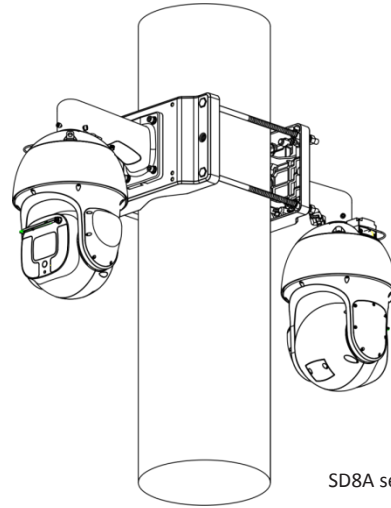

SD8A series PTZ camera

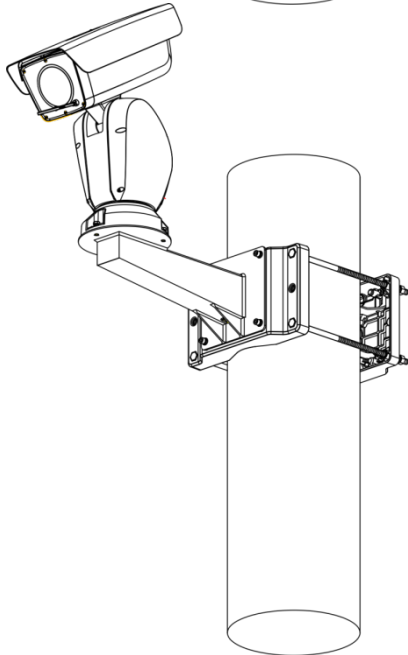

Hybrid pan & tilt camera

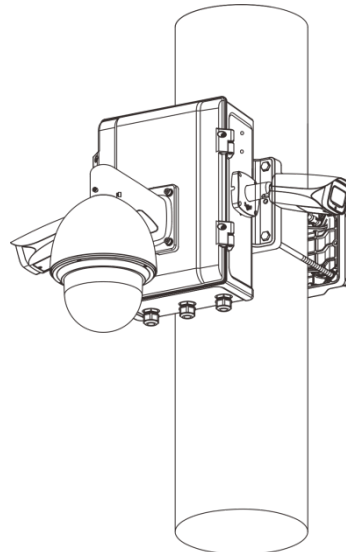

outdoor surveillance box

Package Information

- Pole mount bracket body *2
- M12x360 bolt *4
- M8x35 screw *4
- Washer sleeve *4
- Spring washer *4
- ST3x8 screw *2
- M12 nut *8
- Cable tie *1
- Anti-slide sleeve*1
- S6.0 wrench *1
- User manual *1