

# DHI-ITC314-PH3A-T Series

## Smart Video Parking Detector



- Real-time detection of 6 parking spots. Detection rate of parking spot status:  $\geq 99.5\%$
- 7 indicator colors are available to display the parking spot status
- RS-485 port is designed to connect to the indicator light. One indicator light for one parking spot
- Support H.264, H.265, and MJPEG to meet encoding requirements in different bandwidths and storage environments. H.265 encoding allows high compression ratio and ultra-low bit rate transmission
- Supports cascading power supply through network. Standard 48V DC power supply. A maximum of 6 cascading devices provides ease of installation



### System Overview

The parking spot detector can monitor 6 parking spots in real time, identify vehicles and license plates, and display the parking spot status with different indicator colors (7 colors can be configured).

### Functions

#### Real-time monitoring of parking spot status

Built-in deep learning algorithm helps monitoring the parking spot status in real-time. It can also recognize license plate, and detect behavior of crossing parking line.

#### Seven-color indicator

Integrated seven-color indicator helps display different statuses of the parking spot.

#### Power supply cascading through network

Supports cascading power supply through network. Standard 48V DC power supply. A maximum of 6 cascading devices provides ease of installation.

#### Wide dynamic range

Supports true WDR, capable of capturing clear details even in strong contrast conditions to ensure detection accuracy, ideal for parking buildings and indoor parking lots.

### Scene

It is applicable to parking buildings and indoor parking lots.

### Technical Specification

#### Basic

Image Sensor	1/3" CMOS
Detected Parking Spots	6
Parking Spot Indicator	1 indicator light. 7 colors are available: Red, yellow, blue, green, cyan, white, pink
Electronic Shutter Speed	1/3 s–1/10000 s (manual/auto)
Image Resolution	2304 × 1296 (OSD black strip excluded)
Video Resolution	2MP (1920 × 1080)
Day/Night	Switch day/night mode according to brightness
Noise Reduction	3DNR
WDR	98 dB
White Balance	Auto
Video Compression	H.264, H.265, MJPEG
Picture Encoding Format	JPEG
Video Bit Rate	H.264: 885kb/s–7078kb/s H.265: 885kb/s–7078kb/s MJPEG: 2654kb/s–21234kb/s
Video Frame Rate	Main stream (1920 × 1080@20fps), sub stream (704 × 576@20fps)
Edge Enhancement	Yes
Exposure Mode	Full auto, customized auto, customized

# Parking Spot Detector | DHI-ITC314-PH3A-T Series

## Function

Security Mode	Authorized username and password, MAC address binding, HTTPS encryption, and network access control
Shutter Mode	Single shutter
OSD Overlay	Time, location, parking spot number, parking spot status, and plate number
Alarm Event	Illegal access, safety anomaly, and more
Auto Registration	Yes
Image Tampering Prevention	Yes. Watermark and verification are available for videos and pictures

## Intelligence

Vehicle Recognition	Supports vehicle detection, license plate recognition, and detection of crossing parking line
Parking Spot Status Detection	Yes. <5 s

## Port

RS-485	1
Network	2 100M Ethernet ports (RJ-45)

## General

Power Supply	12V DC~48V DC
Power Consumption	<8.5W
Operating Temperature	-30°C to +60°C (-22°F to +140°F)
Operating Humidity	10%~90% (no condensation)
Protection Grade	IP50
Dimensions	∅120.3 mm × 153.3 mm (∅4.74" × 6.04") (max diameter × height)
Net Weight	0.7 kg (1.54 lb)
Gross Weight	0.8 kg (1.76 lb)
Installation	Ceiling mounting tray installation
Lens	2.8 mm, 3.6 mm

## Installation

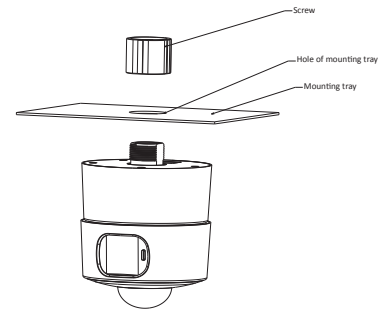

## Dimensions (mm[inch])

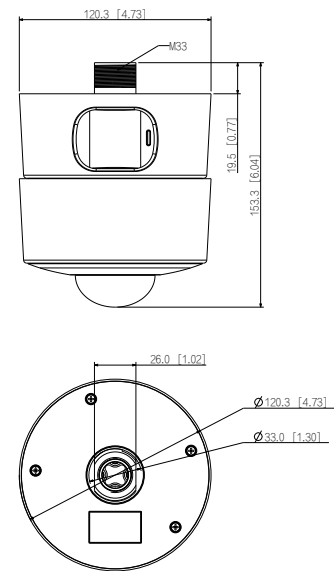

## Ordering Information

Type	Model	Description
Parking Spot Detector	DHI-ITC314-PH3A-TF2-PON	Detection of 6 parking spots; 2.8 mm lens
	DHI-ITC314-PH3A-TF3-PON	Detection of 6 parking spots; 3.6 mm lens