

Exceptional 60fps • WDR Pro • PoE Plus **SD83x1E/83x2E/83x3E**

NETWORK CAMERA *User's Manual*



Rev. 1.0

Table of Contents

Overview	4
Read Before Use.....	5
Package Contents.....	5
Physical Description.....	6
Installation	8
Hardware Installation.....	8
Network Deployment.....	10
Software Installation.....	12
Ready to Use.....	13
Accessing the Network Camera	14
Using Web Browsers.....	14
Using RTSP Players.....	17
Using 3GPP-compatible Mobile Devices.....	18
Using VIVOTEK Recording Software.....	19
Main Page	20
Mouse Control.....	25
Client Settings	26
Configuration	28
System > General settings.....	29
System > Homepage layout.....	31
System > Logs.....	34
System > Parameters.....	35
System > Maintenance.....	36
Security > User Account.....	40
Security > HTTPS (Hypertext Transfer Protocol over SSL).....	41
Security > Access List.....	46
Network > General settings.....	51
Network > Streaming protocols.....	58
Network > SNMP (Simple Network Management Protocol).....	67
Media > Image.....	68
Media > Video.....	78
Media > Audio.....	81
PTZ > PTZ settings.....	82
Event > Event settings.....	84
Applications > Motion detection.....	97
Applications > DI and DO.....	100
Applications > Audio detection.....	101
Recording > Recording settings.....	103
Local storage > SD card management.....	108
Local storage > Content management.....	109
Appendix	111

URL Commands for the Network Camera.....	111
Technical Specifications	192
Technology License Notice.....	193
Electromagnetic Compatibility (EMC).....	194

Overview

VIVOTEK SD83x1E/2E/3E is a series of high performance day/night speed dome network cameras suitable for professional outdoor surveillance applications. The IP66-rated housing protects the camera body against rain and dust and the wide temperature range ensures operation under extreme weather conditions. It is especially suitable for monitoring wide open indoor/outdoor spaces such as airports, highways, and parking lots where high-level reliability and precision are always required.

The SD83x1E/2E/3E support high-performance H.264/MPEG-4/MJPEG compression technology and offer extra smooth video quality up to 60 fps @ D1 Resolution. Boasting WDR Pro technology, the SD83x1E/2E/3E can also cope with challenging lighting conditions and generate image quality similar to the capabilities of the human eye. With sophisticated pan/tilt mechanism, the camera provides fast, precise movement with continuous 360-degree pan and 90-degree tilt. Users can easily control the lens position via a mouse or a joystick to track the object of interest and set up to 128 preset positions for patrolling.

As with all VIVOTEK true day/night cameras, the SD83x1E/2E/3E feature removable IR-cut filter, maintaining clear images 24 hours a day. The built-in SD/SDHC card slot offers a convenient and portable storage option to prevent data loss in case of network disconnection. With other advanced features such as audio detection, 802.3at compliant PoE Plus and 60 fps high quality video, the SD83x1E/2E/3E are the best choices for the most demanding outdoor surveillance applications.

Read Before Use

The use of surveillance devices may be prohibited by law in your country. The Network Camera is not only a high-performance web-ready camera but can also be part of a flexible surveillance system. It is the user's responsibility to ensure that the operation of such devices is legal before installing this unit for its intended use.

It is important to first verify that all contents received are complete according to the Package Contents listed below. Take note of the warnings in the Quick Installation Guide before the Network Camera is installed; then carefully read and follow the instructions in the Installation chapter to avoid damage due to faulty assembly and installation. This also ensures the product is used properly as intended.

The Network Camera is a network device and its use should be straightforward for those who have basic networking knowledge. It is designed for various applications including video sharing, general security/surveillance, etc. The Configuration chapter suggests ways to best utilize the Network Camera and ensure proper operations. For creative and professional developers, the URL Commands of the Network Camera section serves as a helpful reference to customizing existing homepages or integrating with the current web server.

Package Contents

- SD83xxE
- Black Cover / Clear Dome Cover
- Power Adapter (optional)
- Wall Mount Bracket
- O-ring and Screws / Alignment Sticker
- Metal Ring / Moisture Absorber
- RJ45 Female/Female Coupler
- Quick Installation Guide
- Warranty Card
- Software CD

Physical Description

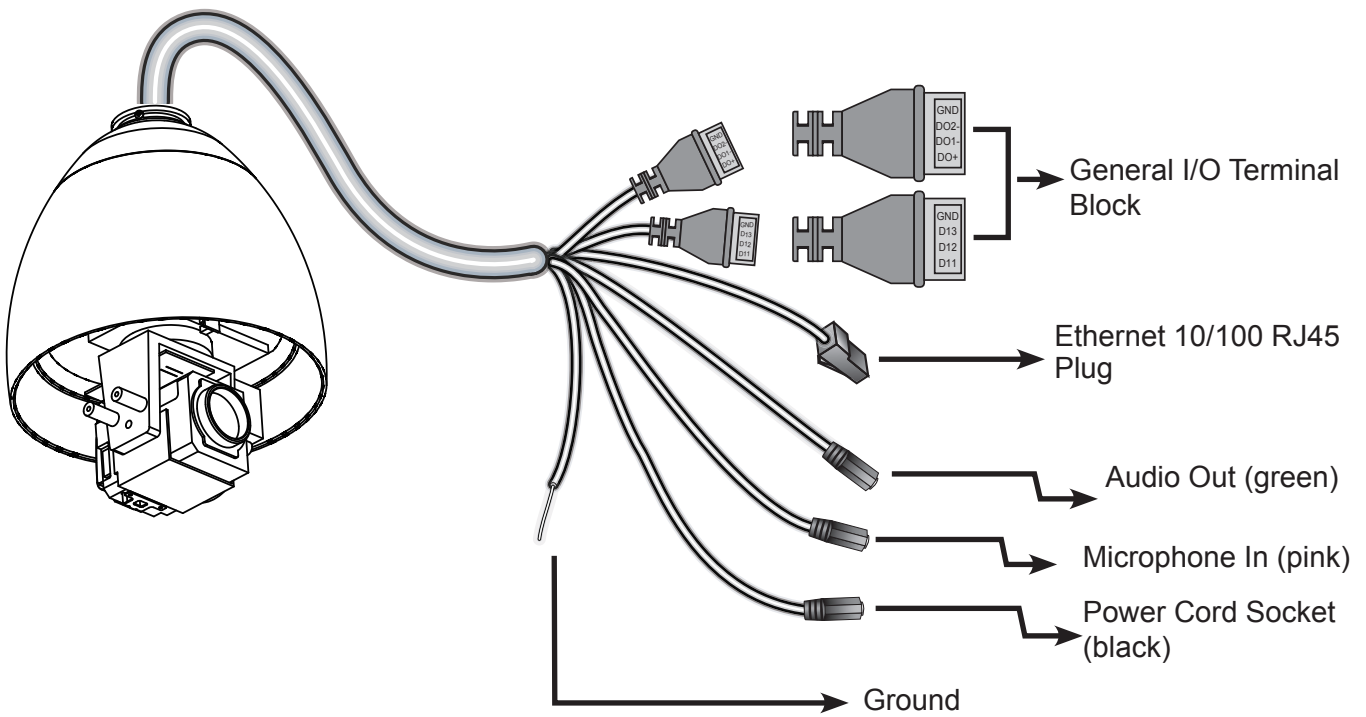
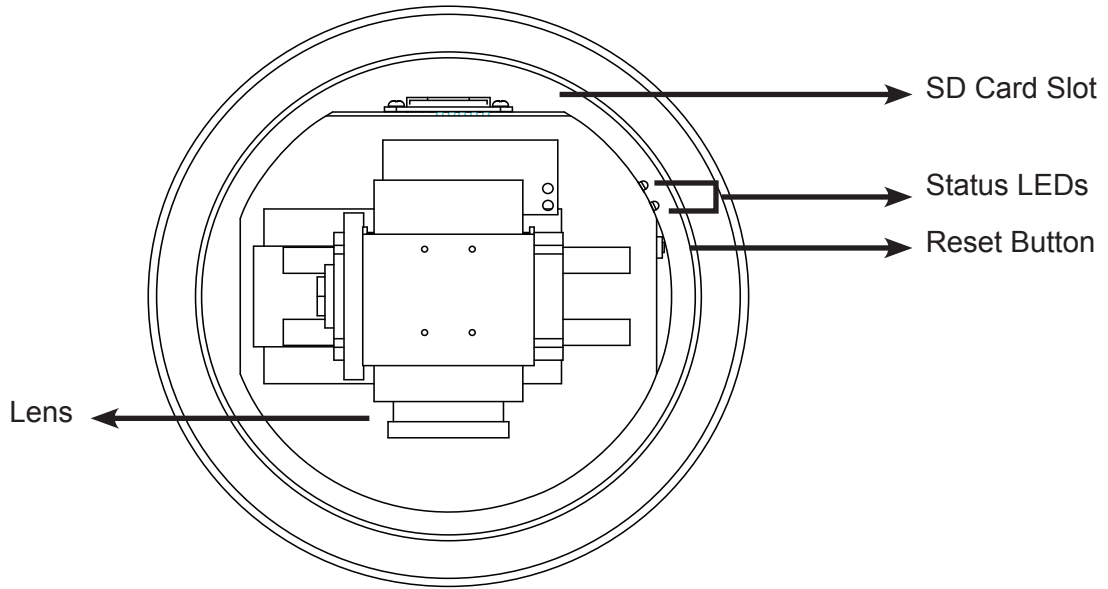

Status LED

Item	LED status	Description
1	Steady red	Power on and system booting
	Red LED off	Power off
2	Steady red & Green blinking every 1 sec.	Network normal (heartbeat)
	Steady red & Green LED off	Network failed
3	Steady red & Green LED blinking every 2 sec.	Audio mute (heartbeat)
4	Red blinking every 0.15 sec. & Green blinking every 1 sec.	Upgrading firmware
5	Red blinking every 0.15 sec. & Green blinking every 0.15 sec.	Restoring default

Hardware Reset

The reset button is used to reset the system or restore the factory default settings. Sometimes resetting the system can return the camera to normal operation. If the system problems remain after reset, restore the factory settings and install again.

Reset: Press and release the recessed reset button with a straightened paper clip. Wait for the Network Camera to reboot.

Restore: Press and hold the recessed reset button for a while to restore. Note that almost all previous configuration changes will be restored to factory default.

SD/SDHC Card Capacity

This network camera is compliant with **SD/SDHC 32GB** and other preceding standard SD cards.

DI/DO Diagram

Please refer to the following illustration for the connection method.

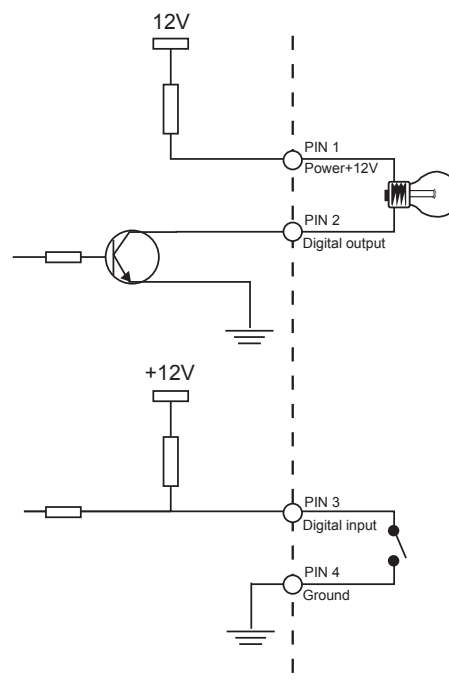

Installation

Hardware Installation

Mounting the Network Camera

1. Attach the alignment sticker to the wall.
2. Drill four pilot holes into the wall.
3. Attach the black cover to the Network Camera using the supplied four black screws.
4. Stick the supplied two pieces of moisture absorber symmetrically to the inner side of the dome cover. Then place the metal ring into the dome cover to fix the moisture absorber.
5. Fix the dome cover to the Network Camera and secure it by rotating it clockwise.
6. Loosen the three screws on the front opening of the wall mount bracket.
7. Place the O-ring on the front opening of the wall mount bracket.
8. Feed the cables through the front opening of the wall mount bracket and pull them from wall outlet.
9. Attach the Network Camera to the wall mount bracket by tightening the three screws you previously removed.
10. Fasten the wall mount bracket to the pre-drilled holes on the wall.

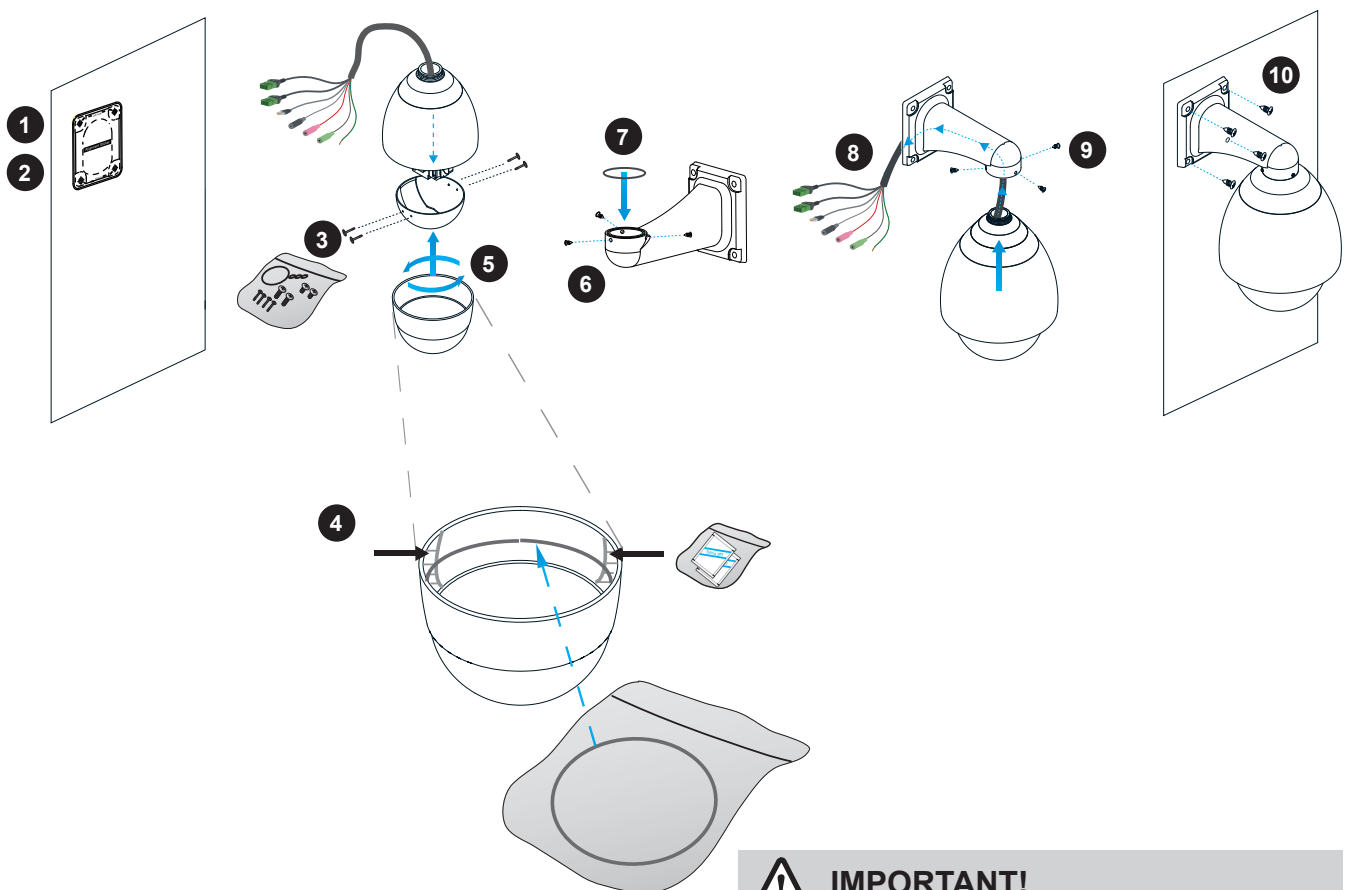

IMPORTANT!

The supplied L-type hex wrenches are exclusively designed to match the camera's screws. Keep them for future use. Do not discard the wrenches.

General Connection (without PoE)

1. If you have external devices such as sensors and alarms, connect them to the general I/O terminal block.

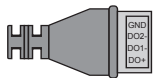

GND: Ground
DO2: Digital Output 2
DO1: Digital Output 1
DO+: Digital Output (DC12V)

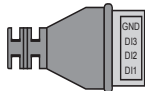

GND: Ground
DI3: Digital Input 3
DI2: Digital Input 2
DI1: Digital Input 1

2. Use the supplied RJ45 female/female coupler to connect the Network Camera to a switch. Use Category 5 Cross Cable when Network Camera is directly connected to a PC.

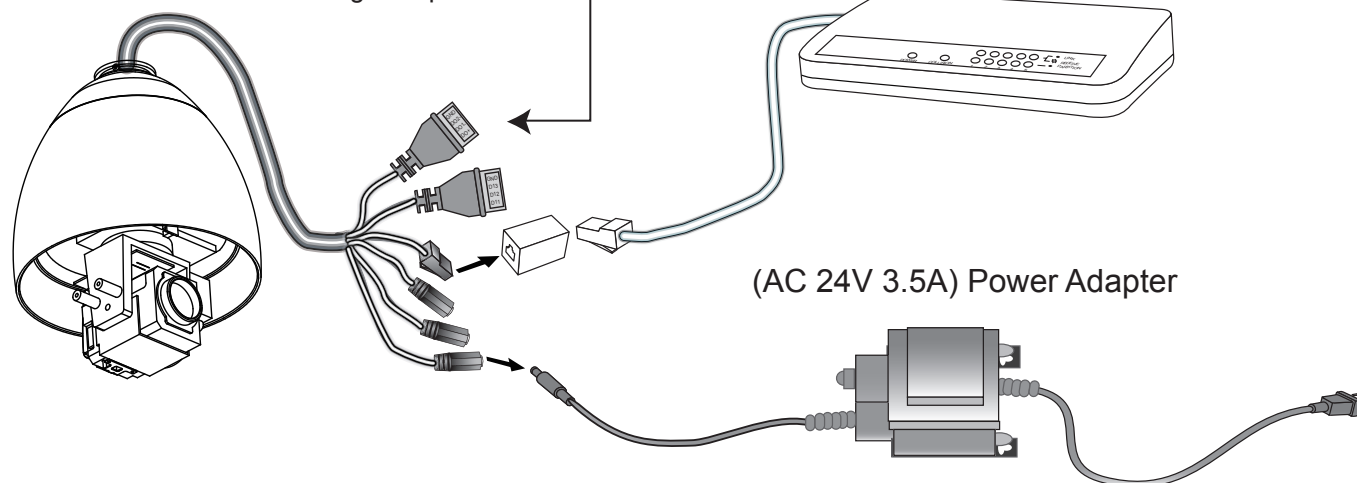

3. Connect the power cable from the Network Camera to a power outlet.

Power over Ethernet (PoE)

When using a non-PoE switch

Use a PoE Plus power injector to connect between the Network Camera and a non-PoE switch.

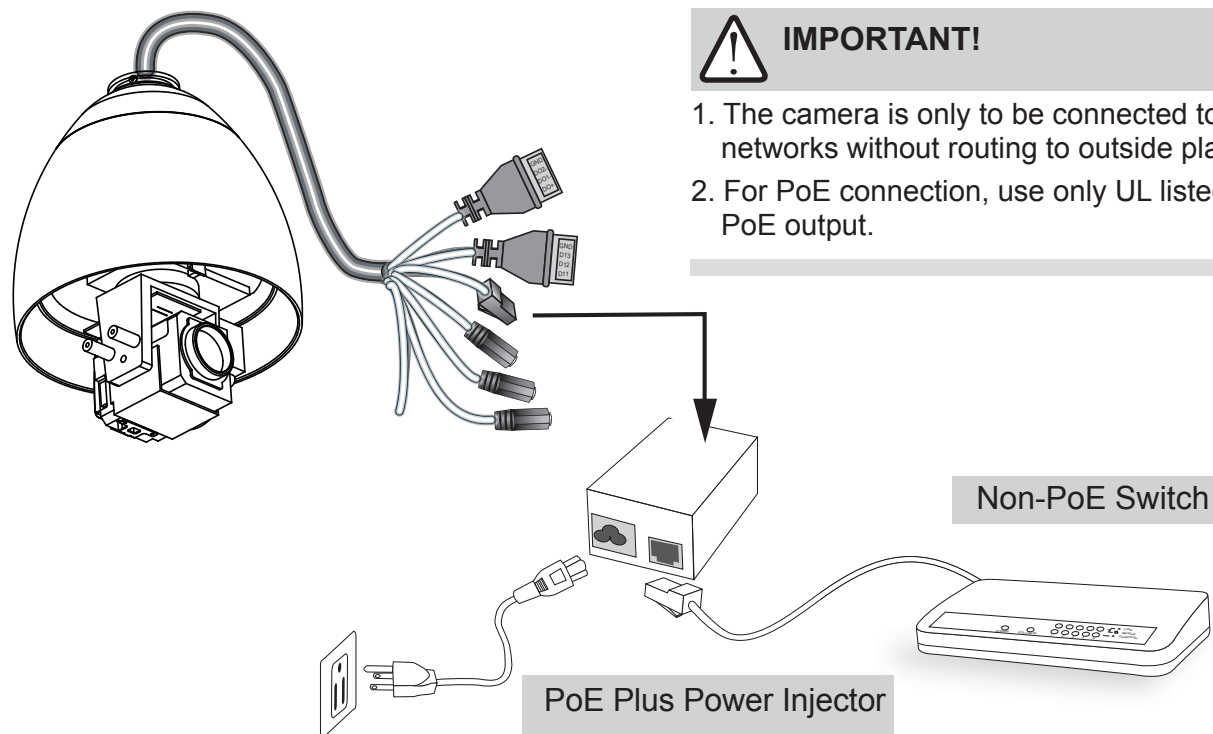

IMPORTANT!

1. The camera is only to be connected to PoE networks without routing to outside plants.
2. For PoE connection, use only UL listed I.T.E. with PoE output.

Network Deployment

Setting up the Network Camera over the Internet

There are several ways to set up the Network Camera over the Internet. The first way is to set up the Network Camera behind a router. The second way is to utilize a static IP. The third way is to use PPPoE.

Internet connection via a router

Before setting up the Network Camera over the Internet, make sure you have a router and follow the steps below.

1. Connect your Network Camera behind a router, the Internet environment is illustrated below. Regarding how to obtain your IP address, please refer to Software Installation on page 12 for details.

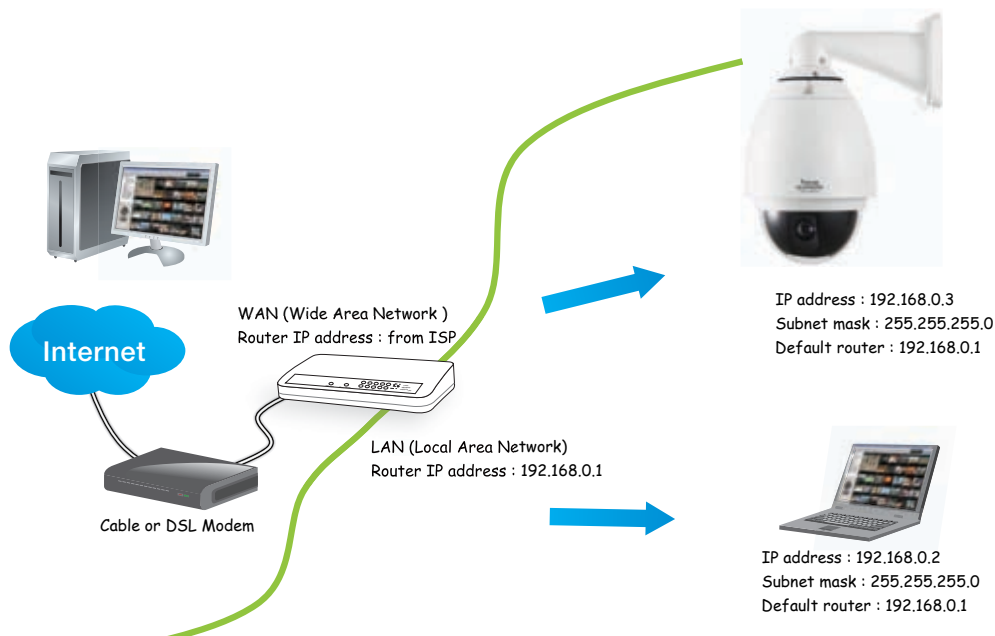

2. In this case, if the Local Area Network (LAN) IP address of your Network Camera is 192.168.0.3, please forward the following ports for the Network Camera on the router.

- Secondary HTTP port
- RTSP port
- RTP port for audio
- RTCP port for audio
- RTP port for video
- RTCP port for video

If you have changed the port numbers on the Network page, please open the ports accordingly on your router. For information on how to forward ports on the router, please refer to your router's user's manual.

3. Find out the public IP address of your router provided by your ISP (Internet Service Provider). Use the public IP and the secondary HTTP port to access the Network Camera from the Internet. Please refer to Network Type on page 51 for details.

Internet connection with static IP

Choose this connection type if you are required to use a static IP for the Network Camera. Please refer to LAN on page 51 for details.

Internet connection via PPPoE (Point-to-Point over Ethernet)

Choose this connection type if you are connected to the Internet via a DSL Line. Please refer to PPPoE on page 52 for details.

Software Installation

Installation Wizard 2 (IW2), free-bundled software included on the product CD, helps you set up your Network Camera on the LAN.

1. Install IW2 under the Software Utility directory from the software CD.
Double click the IW2 shortcut on your desktop to launch the program.



2. The program will conduct an analysis of your network environment.
After your network environment is analyzed, please click **Next** to continue the program.

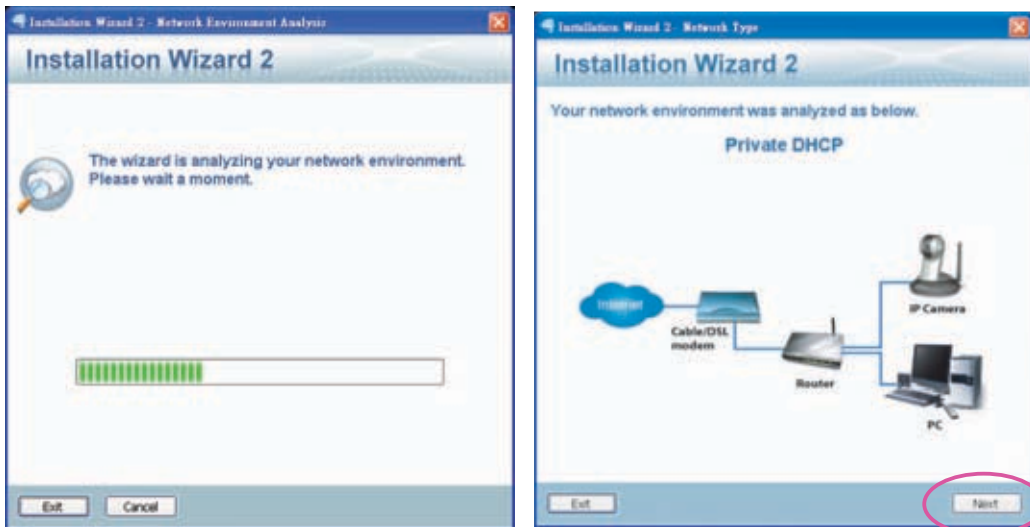

3. The program will search for all VIVOTEK network devices on the same LAN.
4. After a brief search, the main installer window will prompt. Double-click on the MAC and model name which matches the product label on your device to connect to the Network Camera via a web browser.

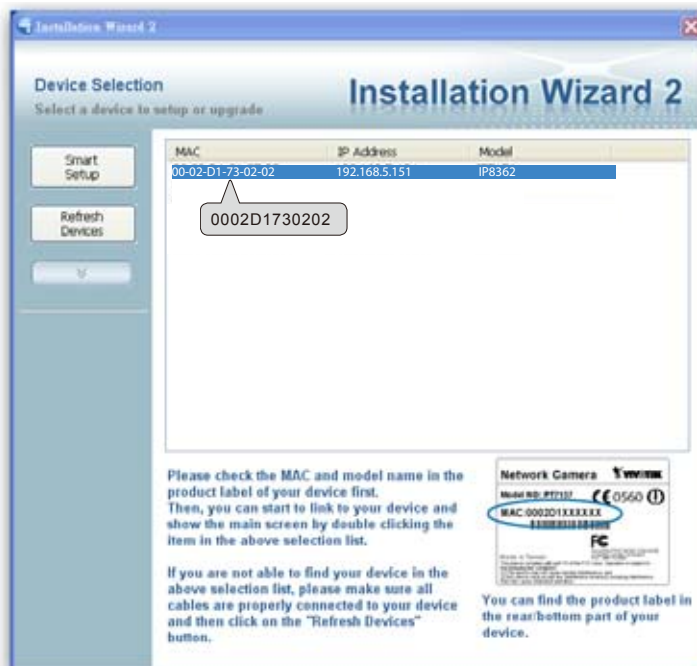

Ready to Use

1. A browser session with the Network Camera should prompt as shown below.
2. You should be able to see live video from your camera. You may also install the 32-channel recording software from the software CD in a deployment consisting of multiple cameras. For its installation details, please refer to its related documents.

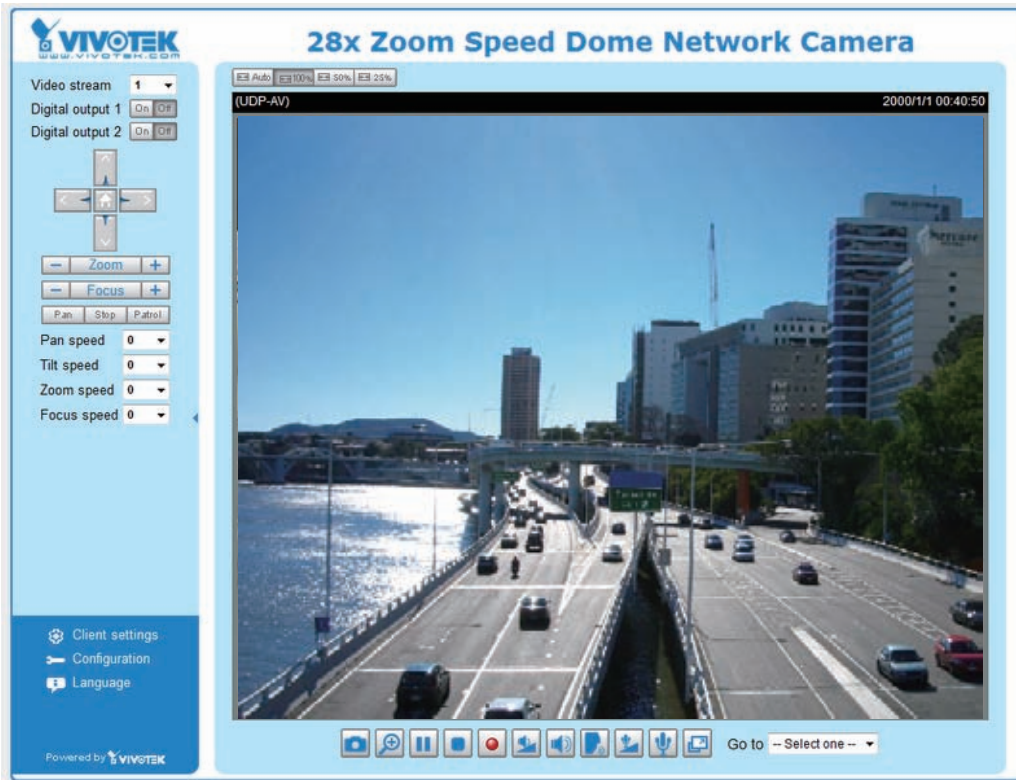

Accessing the Network Camera

This chapter explains how to access the Network Camera through web browsers, RTSP players, 3GPP-compatible mobile devices, and VIVOTEK recording software.

Using Web Browsers

Use Installation Wizard 2 (IW2) to access to the Network Cameras on the LAN.

If your network environment is not a LAN, follow these steps to access the Network Camera:

1. Launch your web browser (e.g., Microsoft® Internet Explorer, Mozilla Firefox, or Netscape).
2. Enter the IP address of the Network Camera in the address field. (A temporary IP will be generated for the camera. Find it in your Network Neighborhood). Press **Enter**.
3. Live video will display in your web browser.
4. If it is the first time installing the VIVOTEK network camera, an information bar will pop up as shown below. Follow the instructions to install the required plug-in on your computer.

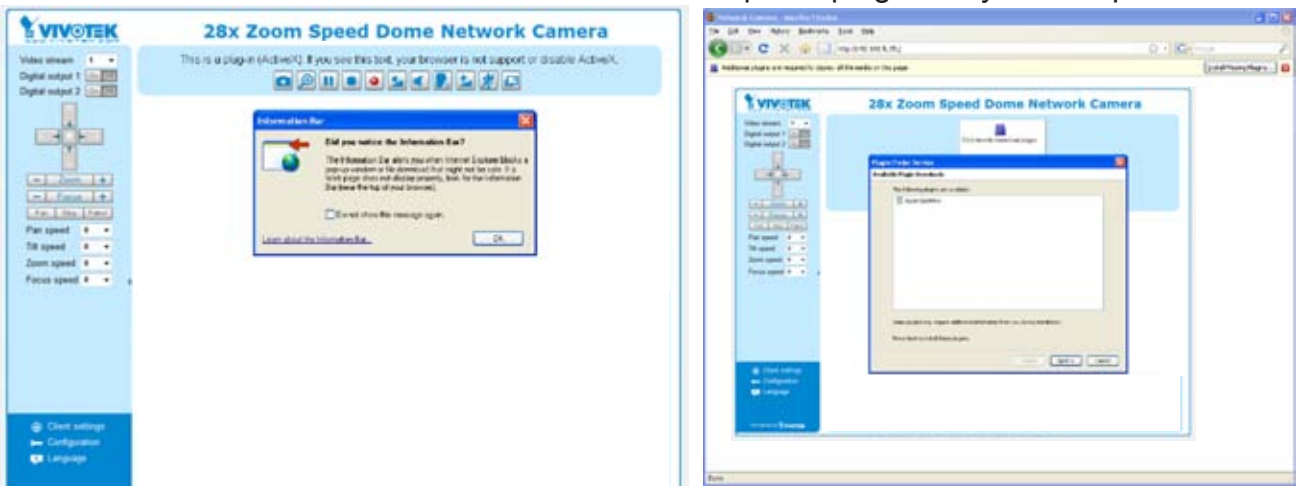

IMPORTANT!

- Currently the Network Camera utilizes 32-bit ActiveX plugin. You CAN NOT open a management/view session with the camera using a 64-bit IE browser.
- If you encounter this problem, try execute the iexplore.exe program from C:\Windows\SysWOW64. A 32-bit version of IE browser will be installed.
- On Windows 7, the 32-bit explorer browser can be accessed from here: C:\Program Files (x86)\Internet Explorer\iexplore.exe

**NOTE:**

For Mozilla Firefox or Netscape users, your browser will use Quick Time to stream live video. If you do not have Quick Time on your computer, please download Quick Time from Apple Inc's website, and then launch your web browser.

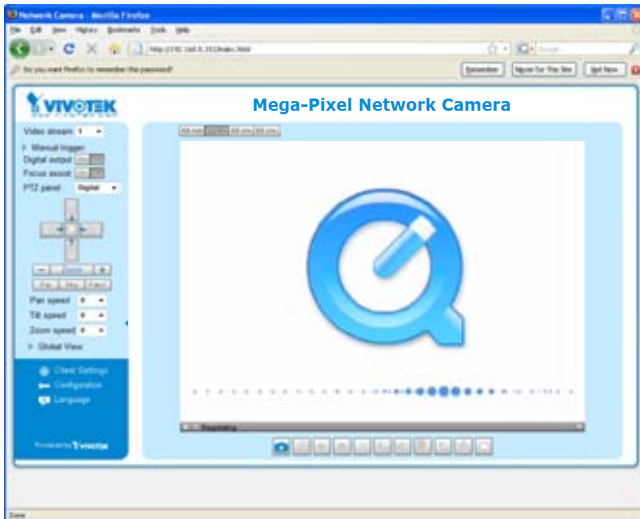

- By default, the Network Camera is not password-protected. To prevent unauthorized access, it is highly recommended to set a password for the Network Camera.

For more information about how to enable password protection, please refer to Security on page 40.

- If you see a dialog box indicating that your security settings prohibit running ActiveX® Controls, please enable the ActiveX® Controls for your browser.

1. Choose Tools > Internet Options > Security > Custom Level.

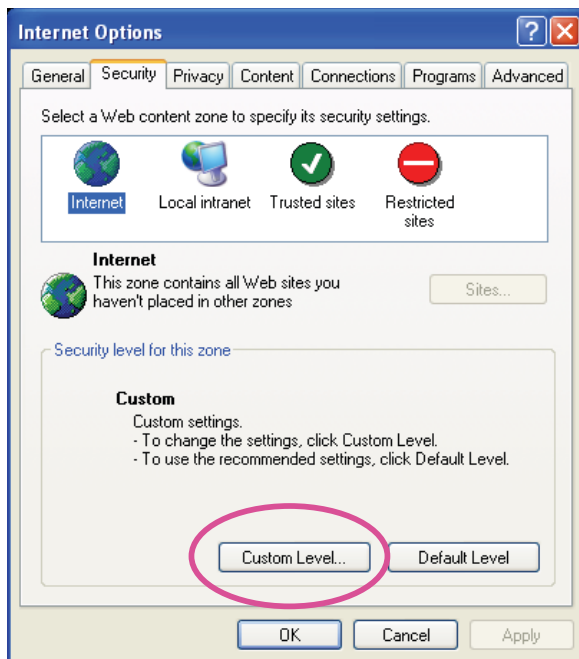

2. Look for Download signed ActiveX® controls; select Enable or Prompt. Click OK.

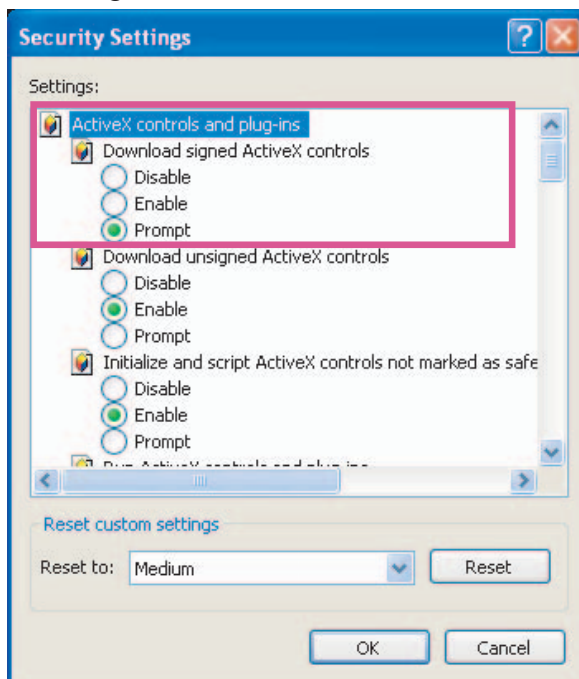

3. Refresh your web browser, then install the ActiveX® control. Follow the instructions to complete installation.

Using RTSP Players

To view the H.264/MPEG-4 streaming media using RTSP players, you can use one of the following players that support RTSP streaming.



Quick Time Player



Real Player

1. Launch the RTSP player.
2. Choose File > Open URL. An URL dialog box will pop up.
3. The address format is `rtsp://<ip address>:<rtsp port>/<RTSP streaming access name for stream1 or stream2>`

As most ISPs and players only allow RTSP streaming through port number 554, please set the RTSP port to 554. For more information, please refer to RTSP Streaming on page 59.

For example:

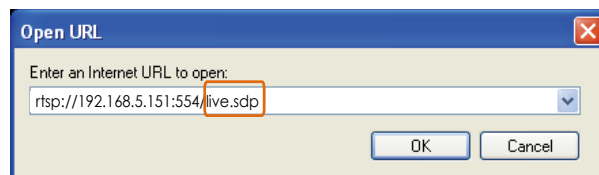

4. The live video will be displayed in your player.
For more information on how to configure the RTSP access name, please refer to RTSP Streaming on page 59 for details.



Using 3GPP-compatible Mobile Devices

To view the streaming media through 3GPP-compatible mobile devices, make sure the Network Camera can be accessed over the Internet. For more information on how to set up the Network Camera over the Internet, please refer to Setup the Network Camera over the Internet on page 10.

To utilize this feature, please check the following settings on your Network Camera:

1. Because most players on 3GPP mobile phones do not support RTSP authentication, make sure the authentication mode of RTSP streaming is set to disable.
For more information, please refer to RTSP Streaming on page 59.
2. As the bandwidth on 3G networks is limited, you will not be able to use a large video size. Please set the video and audio streaming parameters as listed below.
For more information, please refer to Stream settings on page 78.

Video Mode	MPEG-4
Frame size	176 x 144
Maximum frame rate	5 fps
Intra frame period	1S
Video quality (Constant bit rate)	40kbps
Audio type (GSM-AMR)	12.2kbps

3. As most ISPs and players only allow RTSP streaming through port number 554, please set the RTSP port to 554. For more information, please refer to RTSP Streaming on page 59.
4. Launch the player on the 3GPP-compatible mobile devices (ex. Real Player).
5. Type the following URL commands into the player.
The address format is `rtsp://<public ip address of your camera>:<rtsp port>/<RTSP streaming access name for stream 3>`
For example:

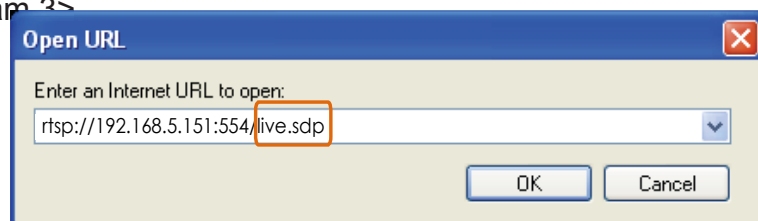

Using VIVOTEK Recording Software

The product software CD also contains recording software, allowing simultaneous monitoring and video recording for multiple Network Cameras. Please install the recording software; then launch the program to add the Network Camera to the Channel list. For detailed information about how to use the recording software, please refer to the user's manual of the software or download it from <http://www.vivotek.com>.



Main Page

This chapter explains the layout of the main page. It is composed of the following sections: VIVOTEK INC. Logo, Host Name, Camera Control Area, Configuration Area, and Live Video Window.



VIVOTEK INC. Logo

Click this logo to visit the VIVOTEK website.

Host Name

The host name can be customized to fit your needs. For more information, please refer to System on page 29.

Camera Control Area

Video Stream: This Network Camera supports multiple streams (stream 1 ~ 4) simultaneously. You can select any of them for live viewing. For more information about multiple streams, please refer to page 78 for detailed information.

Digital Output: Click to turn the digital output device on or off.

PTZ Control Panel:

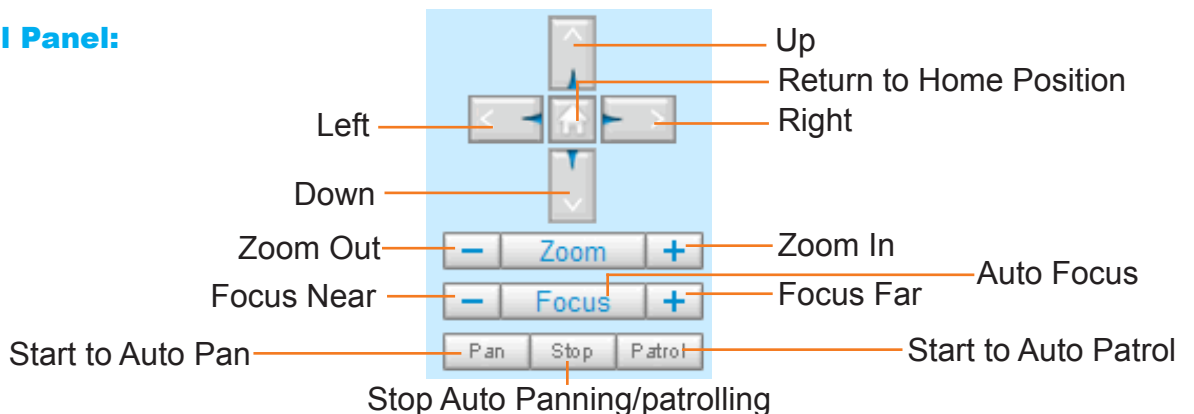

You can also use a joystick or simply mouse clicks on a live view window to move to an area of interest.

Pan: Click this button to start the auto pan (360° continuous rotation).

Stop: Click this button to stop the Auto Pan and Auto Patrol functions.

Patrol: Once the Administrator has determined the list of preset positions, click this button to command the camera to patrol among those positions on the Patrol List. The Network Camera will patrol continuously. For more information, please refer to Camera Control on page 82.

Pan /Tilt /Zoom /Focus speed: Adjust the speed of Pan/ Tilt/ Zoom/ Focus:

Pan speed	Tilt speed	Zoom speed	Focus speed	
-5	-5	-5	-5	Slower
-4	-4	-4	-4	
-3	-3	-3	-3	
-2	-2	-2	-2	
-1	-1	-1	-1	
0	0	0	0	
1	1	1	1	Faster
2	2	2	2	
3	3	3	3	
4	4	4	4	
5	5	5	5	

Configuration Area

Client Settings: Click this button to access the client setting page. For more information, please refer to Client Settings on page 26.

Configuration: Click this button to access the configuration page of the Network Camera. It is suggested that a password be applied to the Network Camera so that only the administrator can configure the Network Camera. For more information, please refer to Configuration on page 28.

Language: Click this button to choose a language for the user interface. Language options are available in: English, Deutsch, Español, Français, Italiano, 日本語, Português, 簡體中文, and 繁體中文. You can also change a language on the Configuration page; please refer to page 28.

Hide Button

You can click the hide button to hide the control panel or display the control panel.

Resize Buttons



Click the Auto button, the video cell will resize automatically to fit the current browser window.

Click 100% is to display the original homepage size.

Click 50% is to resize the homepage to 50% of its original size.

Click 25% is to resize the homepage to 25% of its original size.

Live Video Window

- The following window is displayed when the video mode is set to H.264 / MPEG-4:



Video Title: The video title can be configured. For more information, please refer to Video settings on page 68.

H.264 / MPEG-4 Protocol and Media Options: The transmission protocol and media options for H.264 / MPEG-4 video streaming. For further configuration, please refer to Client Settings on page 26.

Time: Display the current time. For further configuration, please refer to Media > Image > Genral settings on page 68.



Title and Time: The video title and time can be stamped on the streaming video. For further configuration, please refer to Media > Image > General settings on page 68.



Video and Audio Control Buttons: Depending on the Network Camera model and Network Camera configuration, some buttons may not be available.

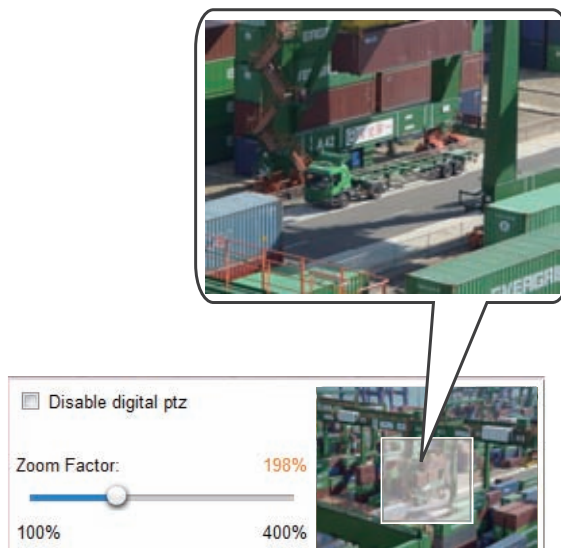

 **Snapshot:** Click this button to capture and save still images. The captured images will be displayed in a pop-up window. Right-click the image and choose **Save Picture As** to save it in JPEG (*.jpg) or BMP (*.bmp) format.



 **Digital Zoom:** Click and uncheck “Disable digital zoom” to enable the zoom operation. The navigation screen indicates the part of the image being magnified. To control the zoom level, drag the slider bar. To move to a different area you want to magnify, drag the navigation screen.







 **Pause:** Pause the transmission of the streaming media. The button becomes the  **Resume** button after clicking the Pause button.



 **Stop:** Stop the transmission of the streaming media. Click the  **Resume** button to continue transmission.



 **Start MP4 Recording:** Click this button to record video clips in MP4 file format to your computer. Press the  **Stop MP4 Recording** button to end recording. When you exit the web browser, video recording stops accordingly. To specify the storage destination and file name, please refer to MP4 Saving Options on page 27 for details.

 **Volume:** When the  **Mute** function is not activated, move the slider bar to adjust the volume on the local computer.

 **Mute:** Turn off the volume on the local computer. The button becomes the  **Audio On** button after clicking the Mute button.

 **Talk:** Click this button to talk to people around the Network Camera. Audio will project from the external speaker connected to the Network Camera. Click this button  again to end talking transmission.

 **Mic Volume:** When the  **Mute** function is not activated, move the slider bar to adjust the microphone volume on the local computer.

 **Mute:** Turn off the  **Mic** volume on the local computer. The button becomes the  **Mic On** button after clicking the Mute button.

 **Full Screen:** Click this button to switch to full screen mode. Press the “Esc” key to switch back to normal mode.

■ The following window is displayed when the video mode is set to MJPEG:





Video Title: The video title can be configured. For more information, please refer to Media > Image on page 68.

Time: Display the current time. For more information, please refer to Media > Image on page 68.



Title and Time: Video title and time can be stamped on the streaming video. For more information, please refer to Media > Image on page 68.

Video and Audio Control Buttons: Depending on the Network Camera model and Network Camera configuration, some buttons may not be available.

 **Snapshot:** Click this button to capture and save still images. The captured images will be displayed in a pop-up window. Right-click the image and choose **Save Picture As** to save it in JPEG (*.jpg) or BMP (*.bmp) format.

 **Digital Zoom:** Click and uncheck “Disable digital zoom” to enable the zoom operation. The navigation screen indicates the part of the image being magnified. To control the zoom level, drag the slider bar. To move to a different area you want to magnify, drag the navigation screen.



 **Start MP4 Recording:** Click this button to record video clips in MP4 file format to your computer. Press the  **Stop MP4 Recording** button to end recording. When you exit the web browser, video recording stops accordingly. To specify the storage destination and file name, please refer to MP4 Saving Options on page 27 for details.

 **Full Screen:** Click this button to switch to full screen mode. Press the “Esc” key to switch back to normal mode.

Mouse Control

In addition to a joystick and the PTZ panel, you can exert mouse control on the live view window. Below are the supported methodologies:

1. You can quickly swipe through the screen by clicking and hold down the left mouse button, and then move your mouse cursor toward the direction you prefer. The same method applies to the PTZ panel buttons.
2. You can also use the mouse wheel to zoom in and zoom out on an area of interest.
3. A single click on a specific point on the screen can bring that point closer to the center of your view window.

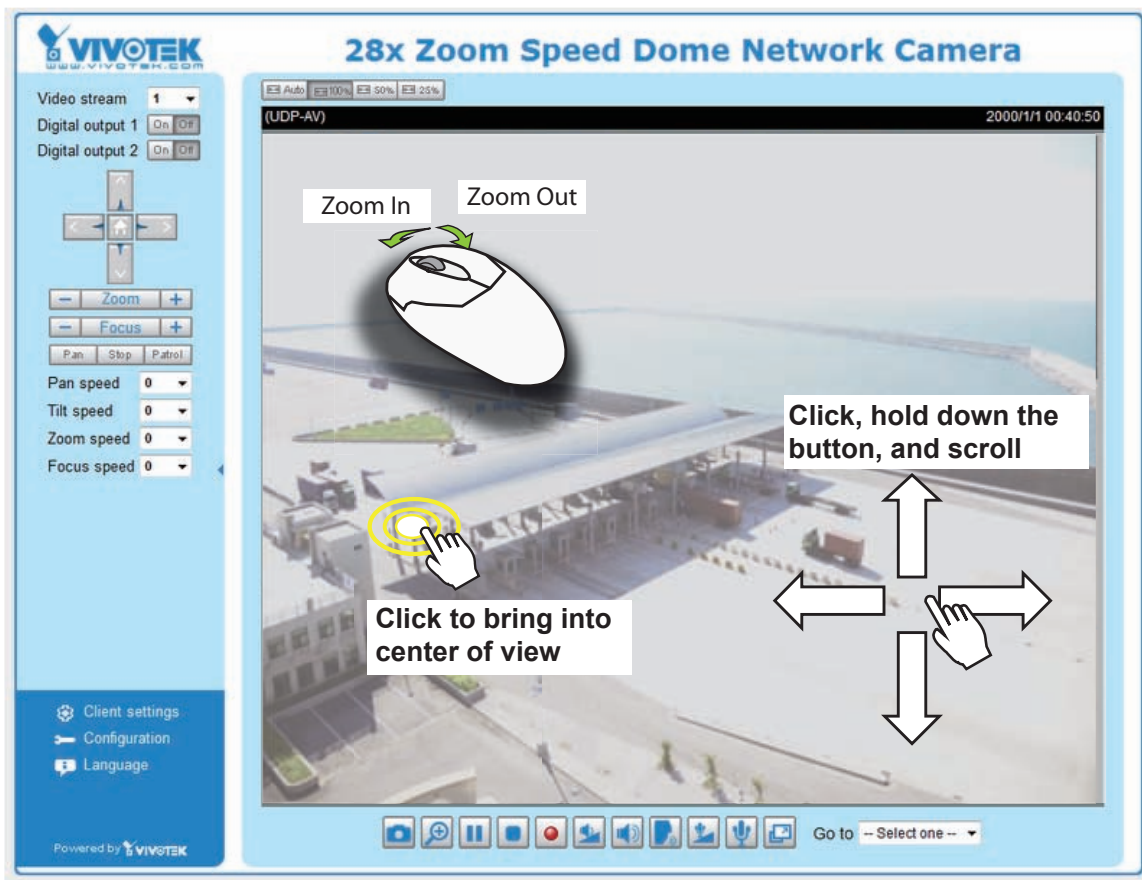

Client Settings

This chapter explains how to select the stream transmission mode and saving options on the local computer. When completed with the settings on this page, click **Save** on the page bottom to enable the settings.

H.264 / MPEG-4 Media Options

H.264/MPEG-4 Media Options

Video and Audio

Video Only

Audio Only

Select to stream video or audio data or both. This is enabled only when the video mode is set to H.264 or MPEG-4.

H.264 / MPEG-4 Protocol Options

H.264/MPEG-4 Protocol Options

UDP Unicast

UDP Multicast

TCP

HTTP

Depending on your network environment, there are four transmission modes of H.264 or MPEG-4 streaming:

UDP unicast: This protocol allows for more real-time audio and video streams. However, network packets may be lost due to network burst traffic and images may be broken. Activate UDP connection when occasions require time-sensitive responses and the video quality is less important. Note that each unicast client connecting to the server takes up additional bandwidth and the Network Camera allows up to ten simultaneous accesses.

UDP multicast: This protocol allows multicast-enabled routers to forward network packets to all clients requesting streaming media. This helps to reduce the network transmission load of the Network Camera while serving multiple clients at the same time. Note that to utilize this feature, the Network Camera must be configured to enable multicast streaming at the same time. For more information, please refer to RTSP Streaming on page 59.

TCP: This protocol guarantees the complete delivery of streaming data and thus provides better video quality. The downside of this protocol is that its real-time effect is not as good as that of the UDP protocol.

HTTP: This protocol allows the same quality as TCP protocol without needing to open specific ports for streaming under some network environments. Users inside a firewall can utilize this protocol to allow streaming data through.

MP4 Saving Options

MP4 Saving Options

Folder:

File name prefix:

Add date and time suffix to file name

Users can record live video as they are watching it by clicking  Start MP4 Recording on the main page. Here, you can specify the storage destination and file name.

Folder: Specify a storage destination for the recorded video files.

File name prefix: Enter the text that will be appended to the front of the video file name.

Add date and time suffix to the file name: Select this option to append the date and time to the end of the file name.

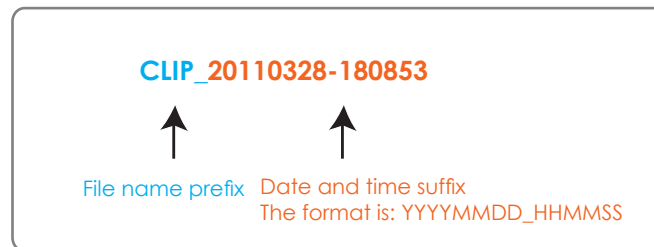

Local Streaming Buffer Time

Local Streaming Buffer Time

Millisecond

Due to the unsteady bandwidth flow, the live streaming may lag and not be very smoothly. If you enable this option, the live streaming will be stored on the camera's buffer area for a few seconds before playing on the live viewing window. This will help you see the streaming more smoothly. If you enter 3000 Millisecond, the streaming will delay for 3 seconds.

Configuration

Click **Configuration** on the main page to enter the camera setting pages. Note that only Administrators can access the configuration page. Please refer to page 40 Security > User Account for how to configure access rights for different users.

VIVOTEK offers an easy-to-use user interface that helps you set up your network camera with minimal effort. To simplify the setting procedure, two types of user interfaces are available: Advanced Mode for professional users and Basic Mode for entry-level users. Some advanced functions (PTZ/ Event/ Recording/ Local storage) are not displayed in Basic Mode.

If you want to set up advanced functions, please click **[Advanced Mode]** on the bottom of the configuration list to quickly switch to Advanced Mode.

In order to simplify the user interface, the detailed information will be hidden unless you click on the function item. When you click on the first sub-item, the detailed information for the first sub-item will be displayed; when you click on the second sub-item, the detailed information for the second sub-item will be displayed and that of the first sub-item will be hidden.

Show below are the locations of the Basic Mode and the Advanced Mode screen elements:

Basic Mode

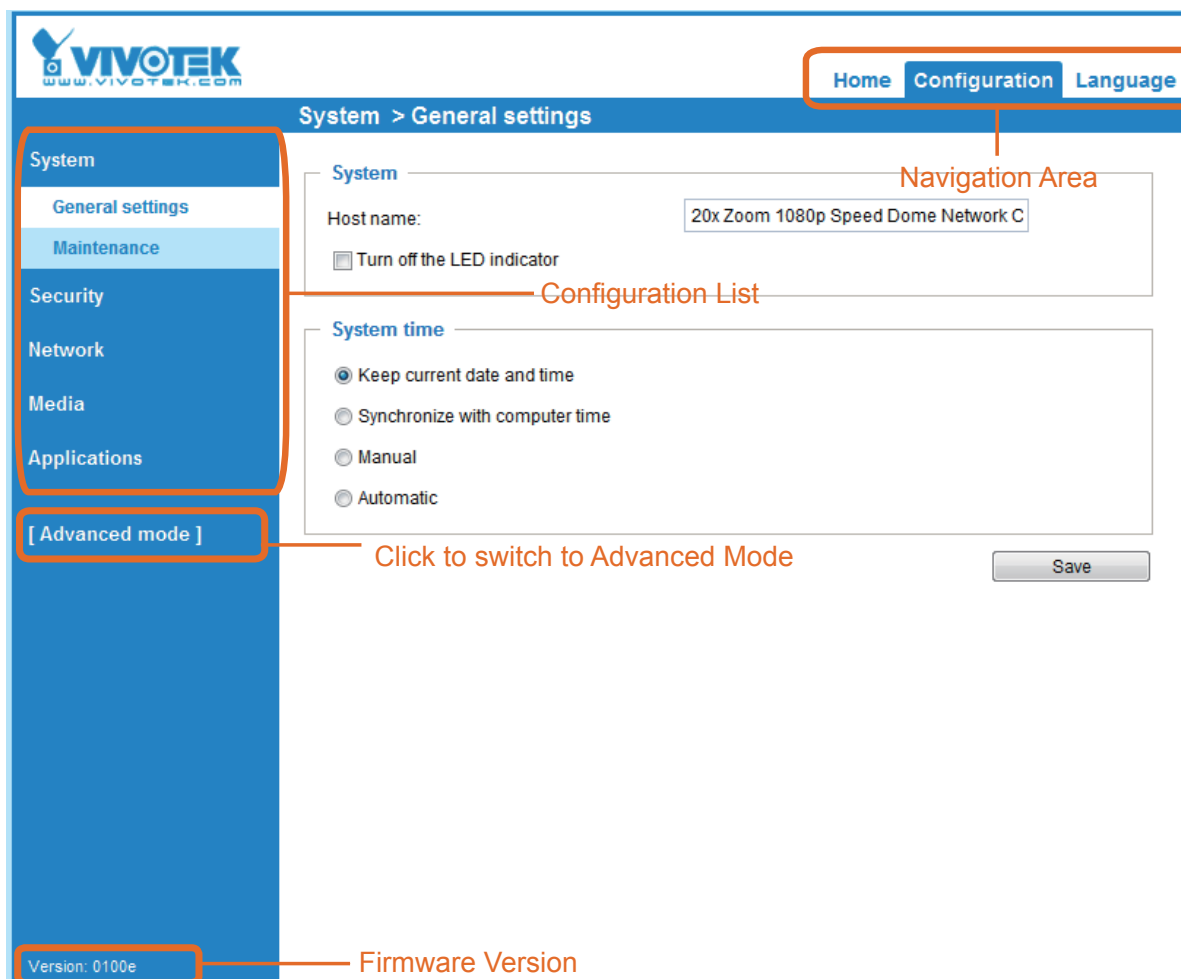

Advanced Mode

Each function on the configuration list will be explained in the following sections. Those functions that are displayed only in Advanced Mode are marked with **Advanced Mode**. If you want to set up advanced functions, please click **[Advanced Mode]** at the bottom of the configuration list to quickly switch over.

The Navigation Area provides an instant switch among **Home** page (the monitoring page for live viewing), **Configuration** page, and multi-language selection.

System > General settings

This section explains how to configure the basic settings for the Network Camera, such as the host name and system time. It is composed of the following two columns: System and System Time.

System

Host name: Enter a desired name for the Network Camera. The text will be displayed at the top of the main page.

Turn off the LED indicator: When checked, the onboard LED will be turned off if you do not want it to be seen. There are cases when you do not want people to know if the camera is operating.

System time

System time

Time zone: GMT+08:00 Beijing, Chongqing, Hong Kong, Kuala Lumpur, Singapore, Taipei

Note: You can upload your daylight saving time rules on [Maintenance](#) page or use the camera default value.

Keep current date and time
 Synchronize with computer time
 Manual
 Automatic

Save

Keep current date and time: Select this option to preserve the current date and time of the Network Camera. The Network Camera's internal real-time clock maintains the date and time even when the power of the system is turned off.

Synchronize with computer time: Select this option to synchronize the date and time of the Network Camera with the local computer. The read-only date and time of the PC is displayed as updated.

Manual: The administrator can enter the date and time manually. Note that the date and time format are [yyyy/mm/dd] and [hh:mm:ss].

Automatic: The Network Time Protocol is a protocol which synchronizes computer clocks by periodically querying an NTP Server.

NTP server: Assign the IP address or domain name of an established time server. Leaving the text box blank connects the Network Camera to the default time servers.

Update interval: Select to update the time using the NTP server on an hourly, daily, weekly, or monthly basis.

Time zone Advanced Mode: Select the appropriate time zone from the list. If you want to upload Daylight Savings Time rules, please refer to **System > Maintenance > Import/ Export files** on page 37 for details.

When finished with the settings on this page, click **Save** at the bottom of the page to enable the settings.

System > Homepage layout Advanced Mode

This section explains how to set up your own customized homepage layout.

General settings

This column shows the settings of your homepage layout. You can manually select the background and font colors in Theme Options (the second tab on this page). The settings will be displayed automatically in this Preview field. The following shows the homepage using the default settings:



- **Hide Powered by VIVOTEK:** If you check this item, such wording will be removed from the homepage.

Logo graph

Here you can change the logo at the top of your homepage.

Logo graph

A customized logo (Gif, JPG or PNG) can be uploaded for main page. It will be resized to 160x50 pixels to replace the previous logo.

Default
 Custom





Logo link:

Follow the steps below to upload a new logo:

1. Click **Custom** and the Browse field will appear.
2. Select a logo from your files.
3. Click **Upload** to replace the existing logo with a new one.
4. Enter a website link if necessary.
5. Click **Save** to enable the settings.

Theme Options

Here you can change the color of your homepage layout. There are three types of preset patterns for you to choose from. The new layout will simultaneously appear in the **Preview** filed. Click **Save** to enable the settings.

General settings | Theme options

Font Color of the Video Title

Font Color

Background Color of the Control Area

Font Color of the Configuration Area

Background Color of the Configuration Area

Background Color of the Video Area

Frame Color

Themes

Color

Font color: #000000

Font color of configuration area: #FFFFFF

Font color of video title: #098BD6

Bk color of control area: #C4EAFF

Bk color of configuration area: #0186D1

Bk color of video area: #C4EAFF

Frame color: #0186D1

Save

Preset patterns

General settings | Theme options

VIVOTEK
www.vivotek.com

Mega-Pixel Network

Video stream 1

Digital output On Off

Manual trigger:

Client settings

Powered by VIVOTEK

General settings | Theme options

VIVOTEK
www.vivotek.com

Mega-Pixel Network

Video stream 1

Digital output On Off

Manual trigger:

Client settings

Powered by VIVOTEK

- Follow the steps below to set up a customized homepage:
 - Click **Custom** on the left column.
 - A double-click on the color selection area (the right hand side column) will bring up a color palette window.

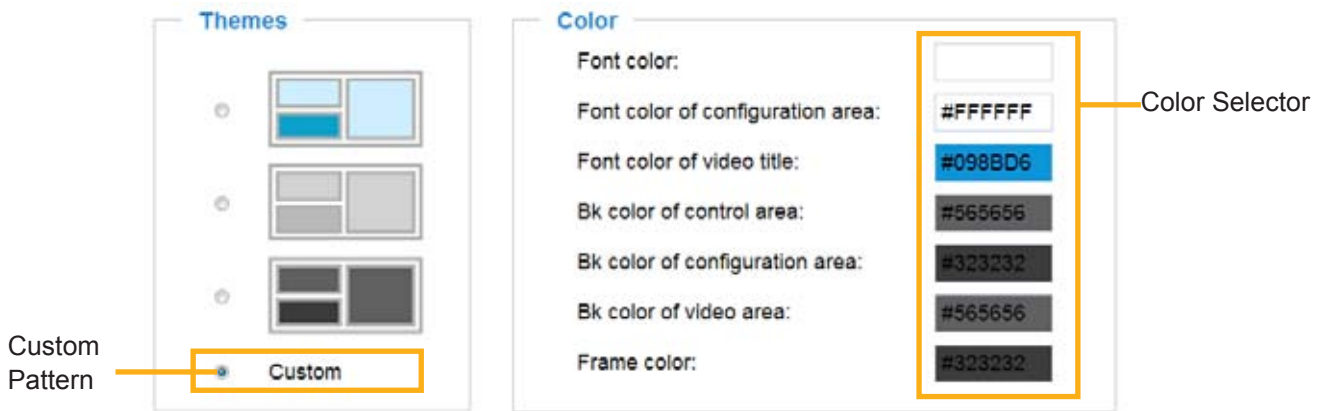

- The palette window will pop up as shown below.

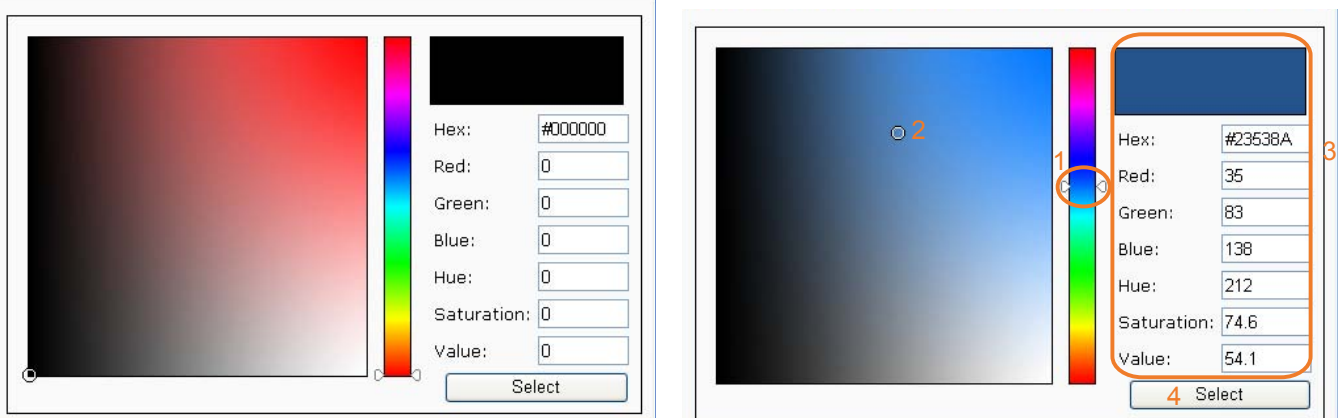

- Drag the slider bar and click on the left square to select a desired color.
- The selected color will be displayed in the corresponding fields and in the **Preview** column.
- Click **Save** to enable the settings.

Below are options for system integrators or VARs. You can use the checkboxes to replace VIVOTEK's company logo, the embedded website address or the slogan "Powered by VIVOTEK." When done, use the Save button to complete the configuration.

Hide Powered by VIVOTEK

Logo graph

A customized logo (Gif, JPG or PNG) can be uploaded for main page. It will be resized to 160x50 pixels to replace the previous logo.

Default Custom

 瀏覽...

Upload

Logo link:

Save

System > Logs Advanced Mode

This section explains how to configure the Network Camera to send the system log to the remote server as backup.

Log server settings

Log server settings

Enable remote log

IP address:

port:

Follow the steps below to set up the remote log:

1. Select **Enable remote log**.
2. In the IP address text box, enter the IP address of the remote server.
2. In the port text box, enter the port number of the remote server.
3. When completed, click **Save** to enable the setting.

You can configure the Network Camera to send the system log file to a remote server as a log backup. Before utilizing this feature, it is suggested that the user install a log-recording tool to receive system log messages from the Network Camera. An example is Kiwi Syslog Daemon. Visit <http://www.kiwisyslog.com/kiwi-syslog-daemon-overview/>.

Date	Time	Priority	Hostname	Message
01-12-2008	15:21:32	User.Info	192.168.5.121	[RTSP SERVER]: Stop one session, IP=192.168.5.122
01-12-2008	15:21:31	User.Info	192.168.5.121	[RTSP SERVER]: Start one session, IP=192.168.5.122
01-12-2008	15:20:47	Syslog.Info	192.168.5.121	syslogd 1.4.1: restart.

System log

This column displays the system log in a chronological order. The system log is stored in the Network Camera's buffer area and will be overwritten when the number of events reaches a preset limit.

```

May 11 14:59:53 syslogd 1.5.0: restart.
May 11 14:59:54 [swatchdog]: Ready to watch httpd.
May 11 14:59:54 [EVENT MGR]: Starting eventmgr with support for EcTun
May 11 14:59:54 [EVENT MGR]: Task conf file: there is no valid event in recording_task.xml, skip it
May 11 14:59:54 [EVENT MGR]: Task conf file: there is no valid event in event_task.xml, skip it
May 11 14:59:55 [ectun]: receiver value of x-path : "camctrl_c0_pr" from configer failed!
May 11 14:59:55 [ectun]: Get Notify parameter "camctrl_c0_pr" value failed
May 11 14:59:55 [ectun]: receiver value of x-path : "eset_i109_name" from configer failed!
May 11 14:59:55 [ectun]: Get Notify parameter "eset_i109_name" value failed
May 11 14:59:56 [DRM Service]: Starting DRM service.
May 11 15:00:05 [UPnPIGDCP]: Search IGD failed
May 11 15:00:06 [swatchdog]: Ready to watch configer.
May 11 15:00:10 [swatchdog]: Ready to watch venc.
May 11 15:00:13 automount[721]: >> mount: mounting /dev/mmcblk0p1 on /mnt/auto/CF
failed: No such device or address
May 11 15:00:13 automount[721]: mount(generic): failed to mount /dev/mmcblk0p1 (type vfat)
on /mnt/auto/CF

```

Access log

Access log displays the access time and IP address of all viewers (including operators and administrators) in a chronological order. The access log is stored in the Network Camera's buffer area and will be overwritten when reaching a certain limit.



System > Parameters Advanced Mode

The View Parameters page lists the entire system's parameters in an alphabetical order. If you need technical assistance, please provide the information listed on this page.

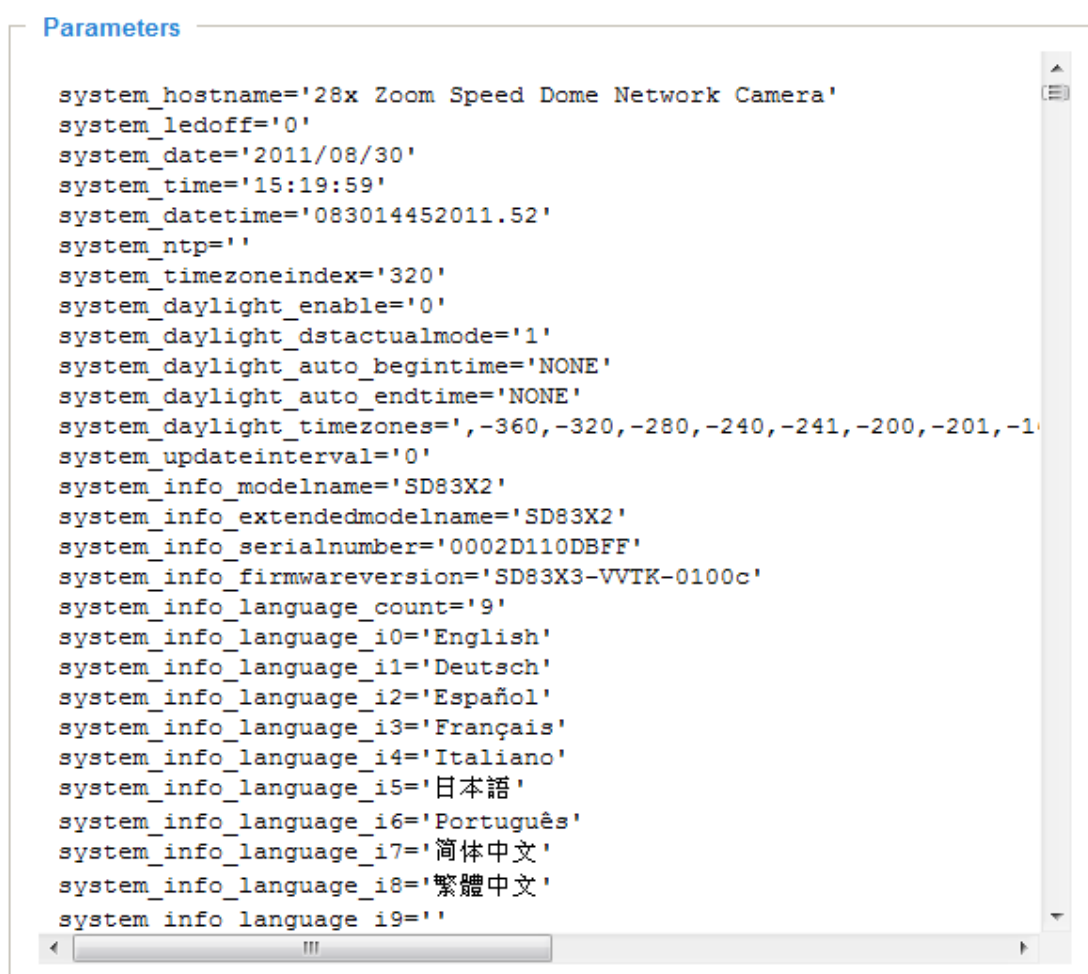

System > Maintenance

This chapter explains how to restore the Network Camera to factory default, reboot, upgrade firmware version, etc.

General settings > Upgrade firmware

This feature allows you to upgrade the firmware of your Network Camera. It takes a few minutes to complete the process.

Note: Do not power off the Network Camera during the upgrade!

Follow the steps below to upgrade the firmware:

1. Download the latest firmware file from the VIVOTEK website. The file is in .pkg file format.
2. Click **Browse...** and specify the firmware file.
3. Click **Upgrade**. The Network Camera starts to upgrade and will reboot automatically when the upgrade completes.

If the upgrade is successful, you will see “Reboot system now!! This connection will close”. After that, refresh the management session with the Network Camera.

The following message is displayed when the upgrade has succeeded.

The following message is displayed when you have selected an incorrect firmware file.

General settings > Reboot

This feature allows you to reboot the Network Camera, which takes about one minute to complete. When completed, the live video page will be displayed in your browser. The following message will be displayed during the reboot process.

If the connection fails after rebooting, manually enter the IP address of the Network Camera in the address field to resume the connection.

General settings > Restore

Restore

Restore all settings to factory default except settings in

Network
 Daylight saving time
 Custom language

This feature allows you to restore the Network Camera's factory defaults.

Network: Select this option to retain the Network Type settings (please refer to Network Type on page 51).

Daylight Saving Time: Select this option to retain the Daylight Saving Time settings (please refer to Import/Export files below on this page).

Custom Language: Select this option to retain the Custom Language settings.

If none of the options is selected, all settings will be restored to factory default. The following message is displayed during the restoring process.

The device is rebooting now. Your browser will reconnect to <http://192.168.5.151:80/>
If the connection fails, please manually enter the above IP address in your browser.

|||||||

Import/Export files Advanced Mode

This feature allows you to Export / Update daylight saving time rules, custom language file, and configuration file.

General settings
Import/Export files

Export files

Export daylight saving time configuration file	<input type="button" value="Export"/>
Export language file	<input type="button" value="Export"/>
Export configuration file	<input type="button" value="Export"/>
Export server status report	<input type="button" value="Export"/>

Upload files

Update daylight saving time rules:	<input type="text"/>	<input type="button" value="Browse..."/>	<input type="button" value="Upload"/>
Update custom language file:	<input type="text"/>	<input type="button" value="Browse..."/>	<input type="button" value="Upload"/>
Upload configuration file:	<input type="text"/>	<input type="button" value="Browse..."/>	<input type="button" value="Upload"/>

Export daylight saving time configuration file: Click to set the start and end time of DST.

Follow the steps below to export:

1. In the Export files column, click **Export** to export the daylight saving time configuration file from the Network Camera.
2. A file download dialog will pop up as shown below. Click **Open** to review the XML file or click **Save** to store the file for editing.

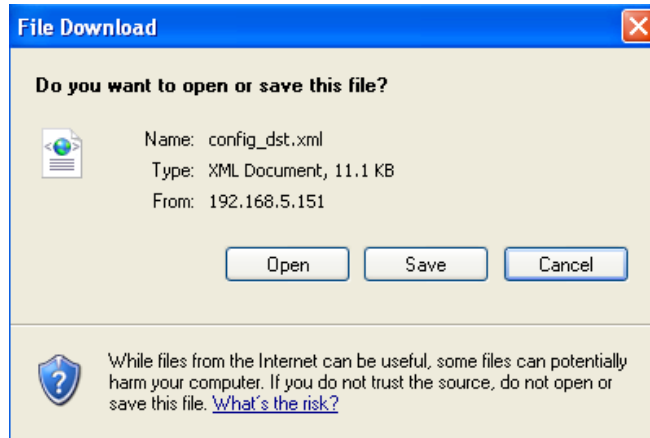

- Open and edit the file using Microsoft® Notepad and locate your time zone in the strings; set the start and end time of DST. When completed, save the file.

In the example below, DST begins each year at 2:00 a.m. on the second Sunday in March and ends at 2:00 a.m. on the first Sunday in November.

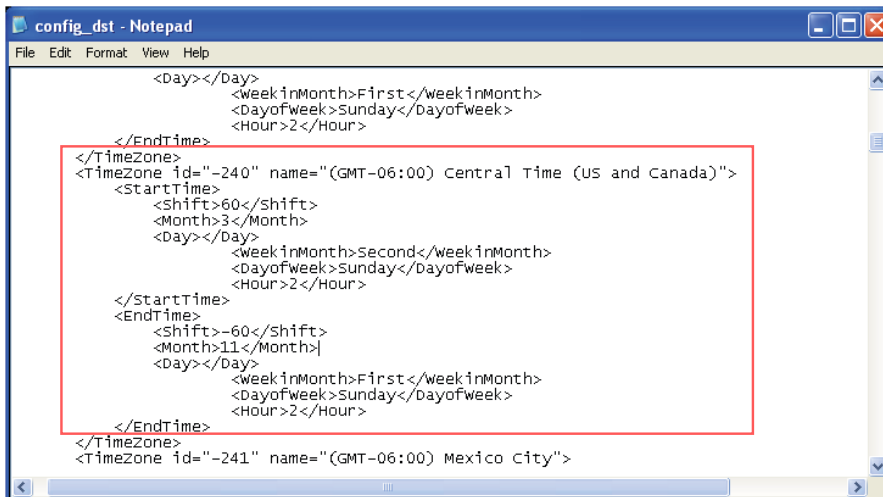

Update daylight saving time rules: Click **Browse...** and specify the XML file to update.

If the incorrect date and time are assigned, you will see the following warning message when uploading the file to the Network Camera.

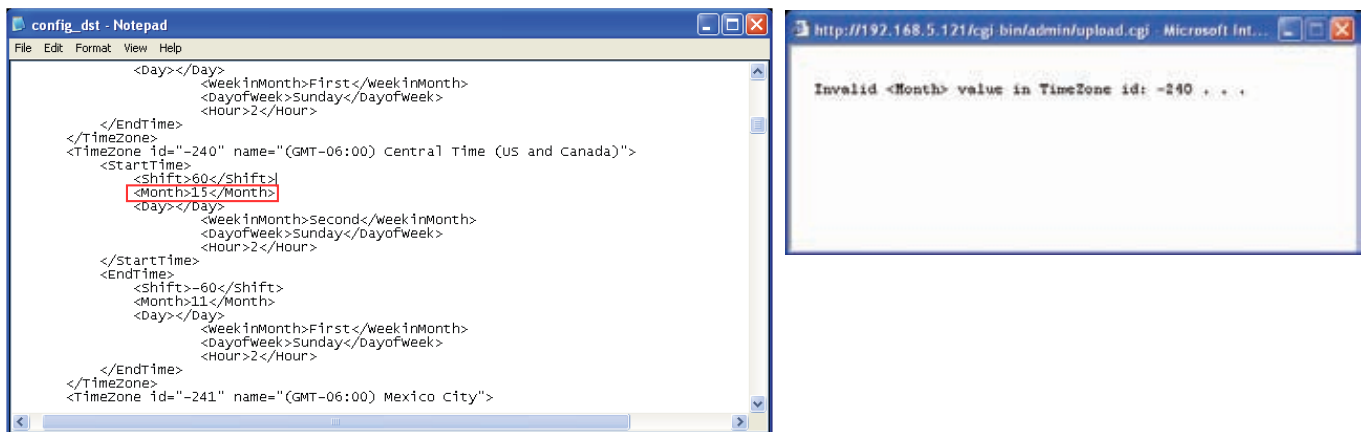

The following message is displayed when attempting to upload an incorrect file format.

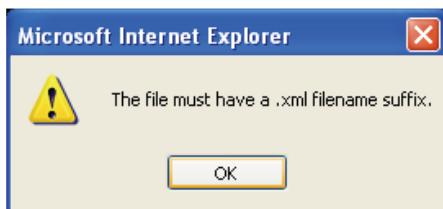

Export language file: Click to export language strings. VIVOTEK provides nine languages: English, Deutsch, Español, Français, Italiano, 日本語, Português, 簡體中文, and 繁體中文.

Update custom language file: Click **Browse...** and specify your own custom language file to upload.

Export configuration file: Click to export all parameters for the device and user-defined scripts.

Update configuration file: Click **Browse...** to update a configuration file. Please note that the model and firmware version of the device should be identical to those specified for the configuration file. If you have set up a fixed IP or other special settings for your device, it is not suggested to update a configuration file.

Export server status report: Click to export the current server status report, such as time, logs, parameters, process status, memory status, file system status, network status, kernel message..., and so on.

Security > User Account

This section explains how to enable password protection and create multiple accounts.

Root Password

The administrator account name is “root”, which is permanent and can not be deleted. If you want to add more accounts in the Manage User column, please apply the password for the “root” account first.

1. Type the password identically in both text boxes, then click **Save** to enable password protection.
2. A window will prompt for authentication; type the correct user’s name and password in their respective fields to access the Network Camera.

Manage Privilege **Advanced Mode**

	Operator	Viewer
Digital output:	<input checked="" type="checkbox"/>	<input type="checkbox"/>
PTZ control:	<input checked="" type="checkbox"/>	<input checked="" type="checkbox"/>
<input type="checkbox"/> Allow anonymous viewing		

Digital Output & PTZ control: You can modify the manage privilege of operators or viewers. Check or uncheck the item, then click **Save** to enable the settings. If you give Viewers the privilege, Operators will also have the ability to control the Network Camera through the main page. (Please refer to Configuration on page 28).

Allow anonymous viewing: If this checkbox is selected, any client can access the live stream without entering a User ID and Password.

Manage User

Administrators can add up to 20 user accounts.

1. Input the new user’s name and password.
2. Select the privilege level for the new user account. Click **Add** to enable the setting.

Access rights are sorted by user privilege (Administrator, Operator, and Viewer). Only administrators can access the Configuration page. Although operators cannot access the Configuration page, they can use the URL Commands to get and set the camera parameters. For more information, please refer to URL Commands of the Network Camera at the Appendix of this manual. Viewers access only the main page for live viewing.

Here you also can change a user’s access rights or delete user accounts.

1. Select an existing account to modify.
2. Make necessary changes and click **Update** or **Delete** to enable the setting.

Security > HTTPS (Hypertext Transfer Protocol over SSL)

Advanced Mode

This section explains how to enable authentication and encrypted communication over SSL (Secure Socket Layer). It helps protect streaming data transmission over the Internet on higher security level.

Create and Install Certificate Method

Before using HTTPS for communication with the Network Camera, a **Certificate** must be created first. There are three ways to create and install a certificate:

Create self-signed certificate automatically

1. Select the first option.
2. Check **Enable HTTPS secure connection**, then select a connection option: "HTTP & HTTPS" or "HTTPS only".
3. Click **Save** to generate a certificate.

Create and install certificate method

- Create self-signed certificate automatically
- Create self-signed certificate manually:
- Create certificate request and install:

Enable HTTPS

Enable HTTPS secure connection:

- HTTP & HTTPS
- HTTPS only

Certificate information

Status: Not installed

Save

Property

4. The Certificate Information will automatically be displayed in the third column as shown below. You can click **Property** to view detailed information about the certificate.

Certificate information

Status: Active

Country: TW

State or province: Asia

Locality: Asia

Organization: Vivotek.Inc

Organization unit: Vivotek.Inc

Common name: www.vivotek.com

Property

- Click **Home** to return to the main page. Change the address prefix from “<http://>” to “<https://>” in the address field and press **Enter** to proceed. Some Security Alert dialogs will pop up. Click **OK** or **Yes** to enable HTTPS.

<https://>

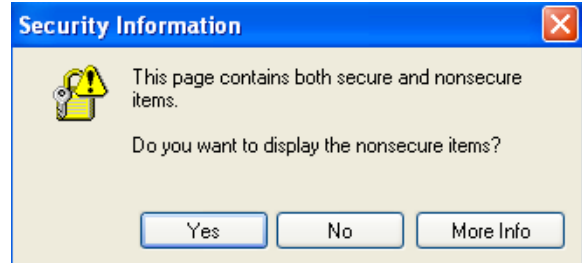
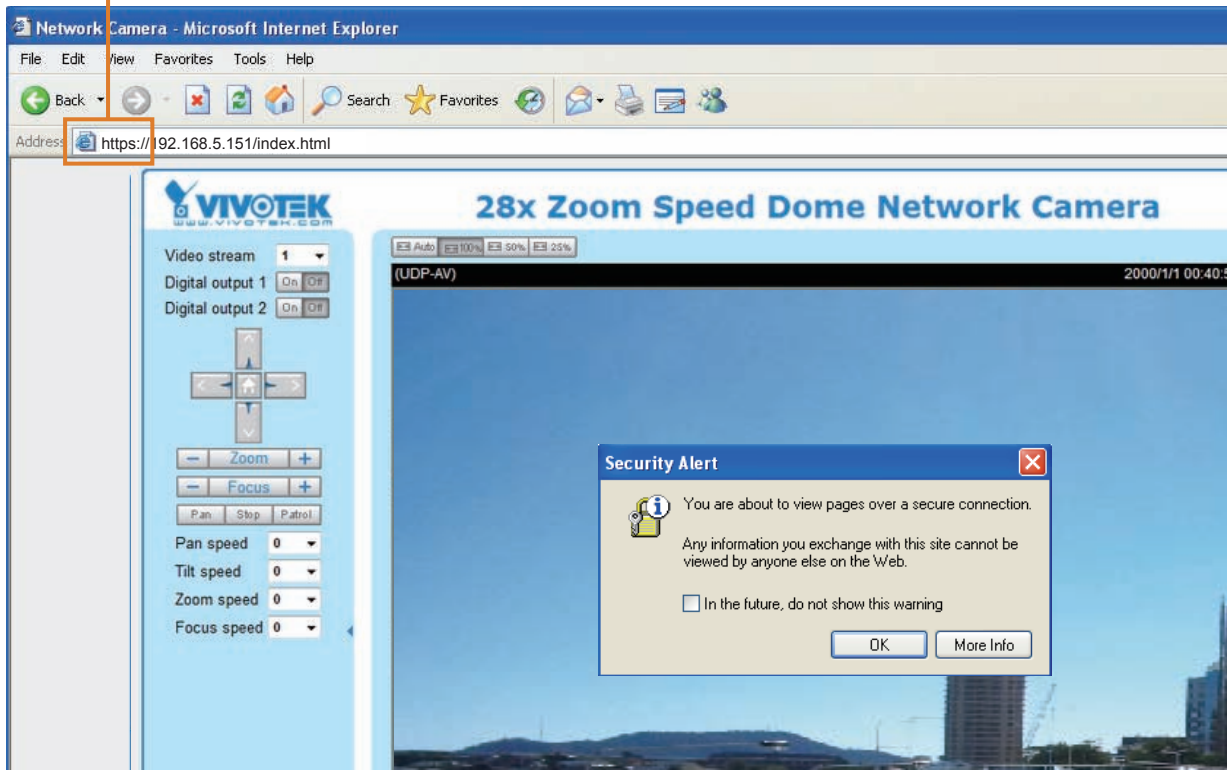

Create self-signed certificate manually

- Select the second option.
- Click **Create** to open the Create Certificate page.

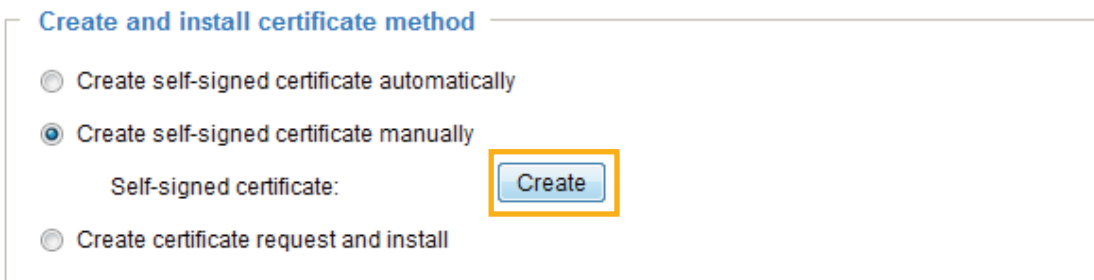

3. The following information will display in a pop-up window after clicking **Create**. Then click **Save** to generate the certificate.

Create certificate

Country: TW

State or province:

Locality:

Organization:

Organization unit: Vivotek.Inc

Common name: www.vivotek.com

Validity: 3650 days

Please wait while the certificate is being generated...

Save Close

4. The Certificate Information will automatically be displayed in the third column as shown below. You can click **Property** to see detailed information about the certificate.

Status: Active

Country: TW

State or province: Asia

Locality: Asia

Organization: Vivotek.Inc

Organization unit: Vivotek.Inc

Common name: www.vivotek.com

Property Remove

5. Check **Enable HTTPS secure connection**, then select a connection option: “HTTP & HTTPS” or “HTTPS only”. Click **Save** to enable the settings.

Create certificate and install : Select this option if you want to create a certificate from a certificate authority.

1. Select the third option.
2. Click **Create** to open the Create Certificate page, then click **Save** to generate the certificate.

Create and install certificate method

Create self-signed certificate automatically

Create self-signed certificate manually

Create certificate request and install

Certificate request: **Create**

Select certificate file: Browse... Upload

Create certificate

Country: TW

State or province:

Locality:

Organization:

Organization unit: Vivotek.Inc

Common name: www.vivotek.com

Please wait while the certificate is being generated...

Save Close

- If you see the following Information bar, click **OK** and click on the Information bar at the top of the page to allow pop-ups.



- The pop-up window shows an example of a certificate request.

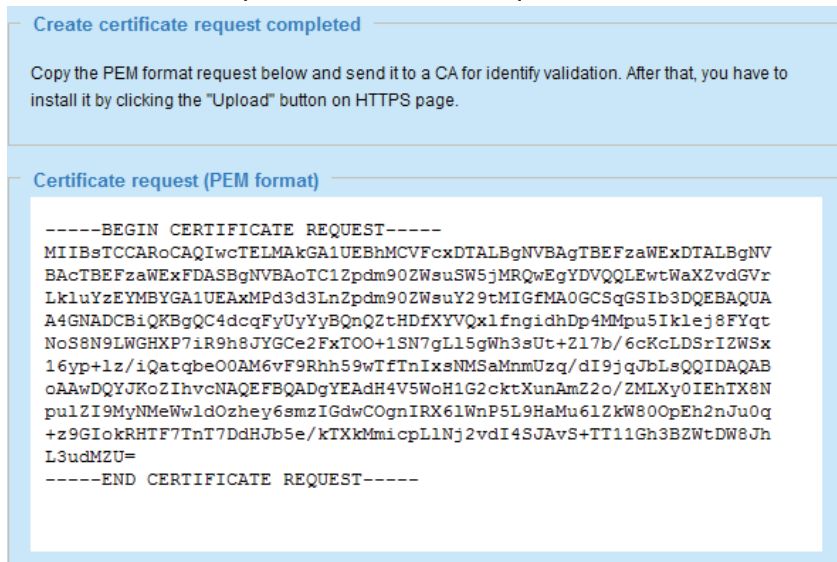

- Look for a trusted certificate authority that issues digital certificates. Enroll the Network Camera. Wait for the certificate authority to issue an SSL certificate; click **Browse...** to search for the issued certificate, then click **Upload** in the column.
- Check **Enable HTTPS secure connection**, then select a connection option: "HTTP & HTTPS" or "HTTPS only". Click **Save** to enable the settings.

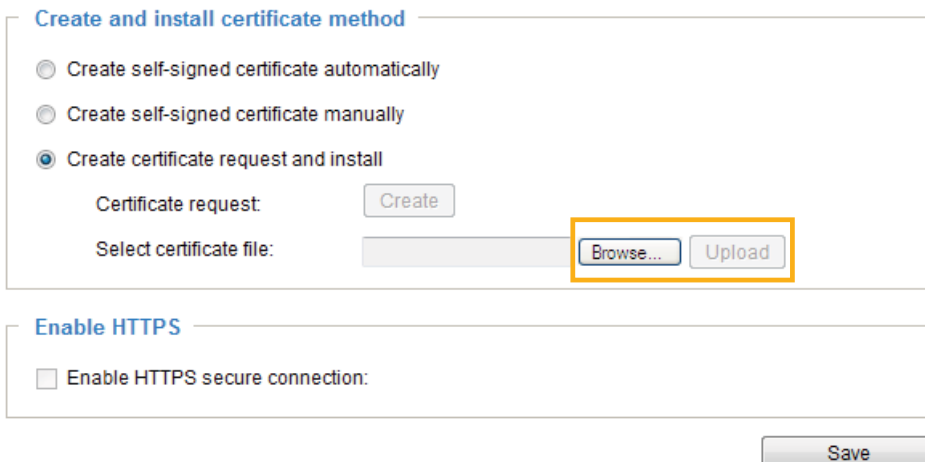

**NOTE:**

How do I cancel the HTTPS setting?

1. Deselect the **Enable HTTPS secure connection** checkbox in the middle column and click Save. A Warning message will prompt.
2. Click **OK** to disable HTTPS.

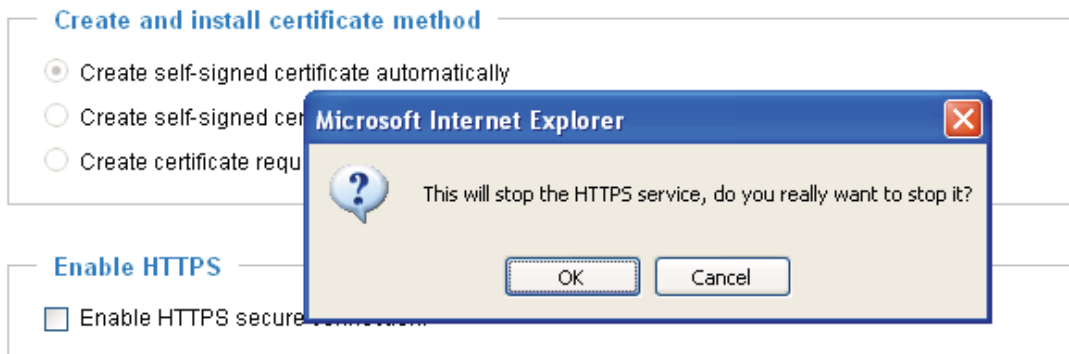

3. The webpage will redirect to a non-HTTPS page automatically.

If you want to create and install other certificates, please remove the existing certificate.

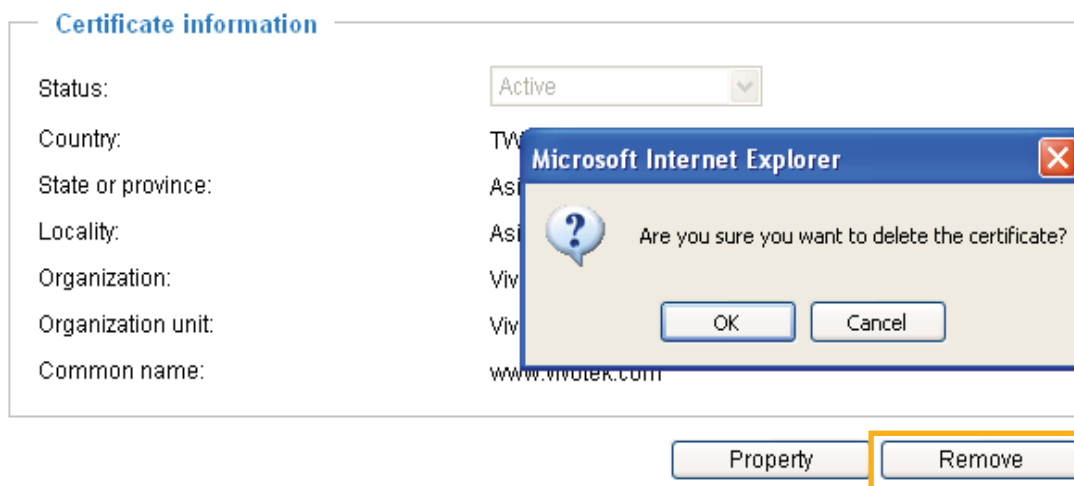

Security > Access List Advanced Mode

This section explains how to control access permission by verifying the client PC's IP address.

General Settings

General settings

Maximum number of concurrent streaming: [View Information](#)

Enable access list filtering

Maximum number of concurrent streaming connection(s) limited to: Simultaneous live viewing for 1~10 clients (including stream 1 and stream 2). The default value is 10. If you modify the value and click **Save**, all current connections will be disconnected and automatically attempt to re-link (IE Explore or Quick Time Player).

View Information: Click this button to display the connection status window showing a list of the current connections. For example:

	IP address	Elapsed time	User ID
<input type="checkbox"/>	192.168.1.147	12:20:34	root
<input type="checkbox"/>	61.22.15.3	00:10:09	
<input type="checkbox"/>	192.168.3.25	45:00:34	greg
<input type="checkbox"/>			
<input type="checkbox"/>			
<input type="checkbox"/>			
<input type="checkbox"/>			
<input type="checkbox"/>			
<input type="checkbox"/>			

- IP address: Current connections to the Network Camera.
- Elapsed time: How much time the client has been at the webpage.
- User ID: If the administrator has set a password for the webpage, the clients have to enter a user name and password to access the live video. The user name will be displayed in the User ID column. If the administrator allows clients to make a connection without a user name and password, the User ID column will be empty.

There are some situations which allow clients access to the live video without a user name and password:

1. The administrator does not set up a root password. For more information about how to set up a root password and manage user accounts, please refer to Security > User account on page 40.
2. The administrator has set up a root password, but set **RTSP Authentication** to "disable". For more information about **RTSP Authentication**, please refer to RTSP Streaming on page 59.
3. The administrator has set up a root password, but allows anonymous viewing. For more information about **Allow Anonymous Viewing**, please refer to page 40.

- Refresh: Click this button to refresh all current connections.
- Add to deny list: You can select entries from the Connection Status list and add them to the Deny List to deny their access. Please note that those checked connections will only be disconnected temporarily and they will automatically retry a connection (IE Explorer or Quick Time Player). If you want to enable the denied list, please check **Enable access list filtering** and click **Save** in the first column.

- **Disconnect:** If you want to break off the current connections, please select them and click this button. Please note that those checked connections will only be disconnected temporarily and they will automatically retry a connection (IE Explore or Quick Time Player).

Enable access list filtering: Check this item and click **Save** if you want to enable the access list filtering function.

Filter

Filter type: Select **Allow** or **Deny** as the filter type. If you choose **Allow Type**, only those clients whose IP addresses are on the Access List below can access the Network Camera, and exclude the access from those that are not on the list. If you choose **Deny Type**, those clients whose IP addresses are on the Access List below will not be allowed to access the Network Camera, while those that are not on the list can.

Filter

Filter type: Allow Deny

Then you can **Add** a rule to the following Access List. Please note that the IPv6 access list column will not be displayed unless you enable IPv6 on the Network page. For more information about **IPv6 Settings**, please refer to Network > Enable IPv6 on page 55 for detailed information.

IPv4 access list

IPv6 access list

There are three types of rules:

Single: This rule allows the user to add an IP address to the Allowed/Denied list.

For example:

Filter address

Rule: ▼

IP address:

Network: This rule allows the user to assign a network address and corresponding subnet mask to the Allow/Deny List in the CIDR format, e.g. 192.168.xx.xx/24.
 For example:

Filter address

Rule: Network ▾

Network address / Network mask: 192.168.2.0 / 24

OK Cancel

IP address 192.168.2.x will be blocked.

Range: This rule allows the user to assign a range of IP addresses to the Allow/Deny List.
 Note: This rule is only applicable to IPv4 addresses.
 For example:

Filter address

Rule: Range ▾

IP address - IP address: 192.168.2.0 - 192.168.2.255

OK Cancel

Administrator IP address

Always allow the IP address to access this device: You can check this item and add the Administrator’s IP address in this field to make sure the Administrator can always connect to the device.

Administrator IP address

Always allow the IP address to access this device

Save

Security > IEEE 802.1x Advanced Mode

Enable this function if your network environment uses IEEE 802.1x, which is a port-based network access control. The network devices, intermediary switch/access point/hub, and RADIUS server must support and have their 802.1x settings enabled.

The 802.1x standard is designed to enhance the security of local area networks, which provides authentication to network devices (clients) attached to a network port (wired or wireless). If all certificates between client and server are verified, a point-to-point connection will be enabled; if authentication fails, access on that port will be prohibited. 802.1x utilizes an existing protocol, the Extensible Authentication Protocol (EAP), to facilitate communication.

■ The components of a protected network with 802.1x authentication:



1. Supplicant: A client end user (camera), which requests authentication.
2. Authenticator (an access point or a switch): A “go between” which restricts unauthorized end users from communicating with the authentication server.
3. Authentication server (usually a RADIUS server): Checks the client certificate and decides whether to accept the end user’s access request.

■ VIVOTEK Network Cameras support two types of EAP methods to perform authentication: **EAP-PEAP** and **EAP-TLS**.

Please follow the steps below to enable 802.1x settings:

1. Before connecting the Network Camera to the protected network with 802.1x, please apply a digital certificate from a Certificate Authority (i.e., network administrator of your company) which can be validated by a RADIUS server.
2. Connect the Network Camera to a PC or notebook outside of the protected LAN. Open the configuration page of the Network Camera as shown below. Select **EAP-PEAP** or **EAP-TLS** as the EAP method. In the following blanks, enter your ID and password issued by the CA, then upload related certificate(s).

IEEE 802.1x

Enable IEEE 802.1x

EAP method: EAP-PEAP ▼

Identity:

Password:

CA certificate:

Status: no file

IEEE 802.1x

Enable 802.1x

EAP method: EAP-TLS ▾

Identity:

Private key password:

CA certificate: Browse... Upload

Status: no file Remove

client certificate: Browse... Upload

Status: no file Remove

Client private key: Browse... Upload

Status: no file Remove

3. When all settings are complete, move the Network Camera to the protected LAN by connecting it to an 802.1x enabled switch. The devices will then start the authentication automatically.



NOTE:

► Below is the authentication process for 802.1x:

1. The Certificate Authority (CA) provides the required signed certificates to the Network Camera (the supplicant) and the RADIUS Server (the authentication server).
2. A Network Camera requests access to the protected LAN using 802.1X via a switch (the authenticator). The client offers its identity and client certificate, which is then forwarded by the switch to the RADIUS Server, which uses an algorithm to authenticate the Network Camera and returns an acceptance or rejection back to the switch.
3. The switch also forwards the RADIUS Server's certificate to the Network Camera.
4. Assuming all certificates are validated, the switch then changes the Network Camera's state to authorized and is allowed access to the protected network via a pre-configured port.

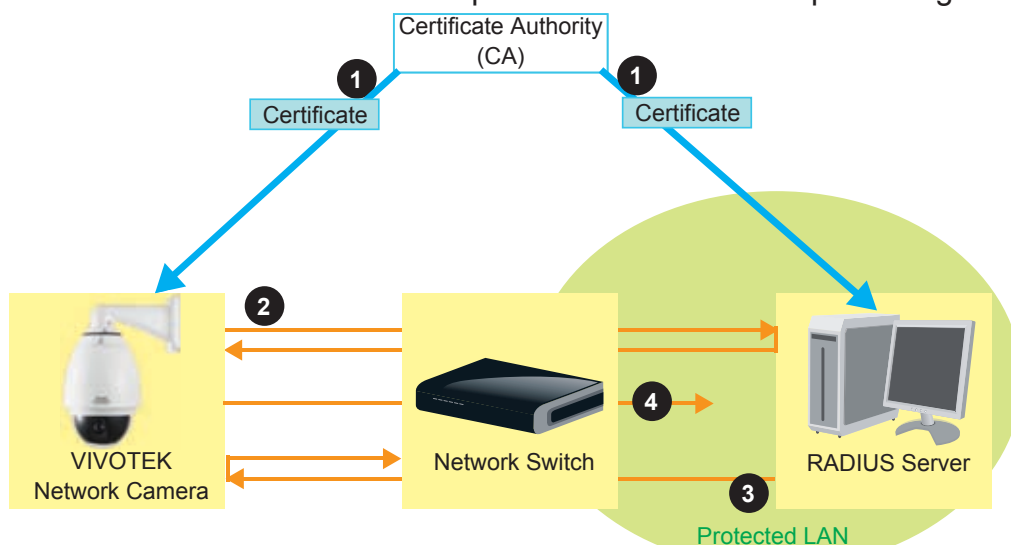

Network > General settings

This section explains how to configure a wired network connection for the Network Camera.

Network Type

Network type

LAN

Get IP address automatically

Use fixed IP address

Enable UPnP presentation

Enable UPnP port forwarding

PPPoE

Enable IPv6

Save

LAN

Select this option when the Network Camera is deployed on a local area network (LAN) and is intended to be accessed by local computers. The default setting for the Network Type is LAN. Remember to click **Save** when you complete the Network setting.

Get IP address automatically: Select this option to obtain an available dynamic IP address assigned by the DHCP server each time the camera is connected to the LAN.

Use fixed IP address: Select this option to manually assign a static IP address to the Network Camera.

Network type

LAN

Get IP address automatically

Use fixed IP address

IP address:

Subnet mask:

Default router:

Primary DNS:

Secondary DNS:

Primary WINS server:

Secondary WINS server:

Enable UPnP presentation

Enable UPnP port forwarding

PPPoE

Enable IPv6

Save

1. You can make use of VIVOTEK Installation Wizard 2 on the software CD to easily set up the Network Camera on LAN. Please refer to Software Installation on page 12 for details.
2. Enter the Static IP, Subnet mask, Default router, and Primary DNS provided by your ISP.

Subnet mask: This is used to determine if the destination is in the same subnet. The default value is "255.255.255.0".

Default router: This is the gateway used to forward frames to destinations in a different subnet. Invalid router setting will fail the transmission to destinations in different subnet.

Primary DNS: The primary domain name server that translates host names into IP addresses.

Secondary DNS: Secondary domain name server that backups the Primary DNS.

Primary WINS server: The primary WINS server that maintains the database of computer name and IP address.

Secondary WINS server: The secondary WINS server that maintains the database of computer name and IP address.

Enable UPnP presentation: Select this option to enable UPnP™ presentation for your Network Camera so that whenever a Network Camera is presented to the LAN, shortcuts of connected Network Cameras will be listed in My Network Places. You can click the shortcut to link to the web browser. Currently, UPnP™ is supported by Windows XP or later. Note that to utilize this feature, please make sure the UPnP™ component is installed on your computer.

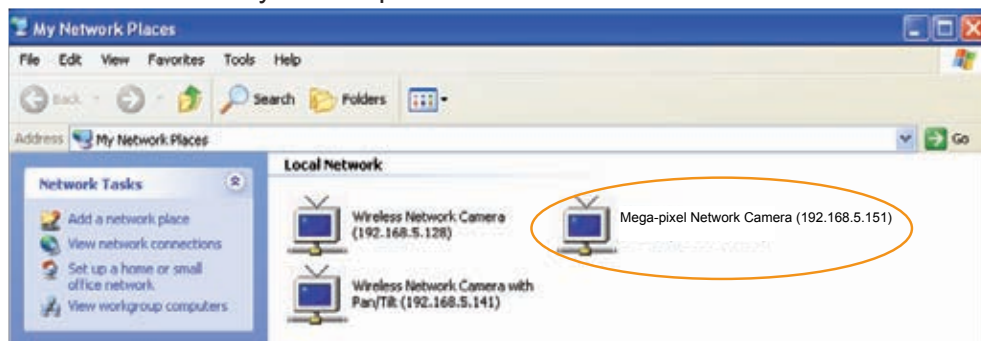

Enable UPnP port forwarding: To access the Network Camera from the Internet, select this option to allow the Network Camera to open ports on the router automatically so that video streams can be sent out from a LAN. To utilize of this feature, make sure that your router supports UPnP™ and it is activated.

PPPoE (Point-to-point over Ethernet)

Select this option to configure your Network Camera to make it accessible from anywhere as long as there is an Internet connection. Note that to utilize this feature, it requires an account provided by your ISP.

Follow the steps below to acquire your Network Camera's public IP address.

1. Set up the Network Camera on the LAN.
2. Go to Configuration > Event > Event settings > Add server (please refer to Add server on page 87) to add a new email or FTP server.
3. Go to Configuration > Event > Event settings > Add media (please refer to Add media on page 91). Select System log so that you will receive the system log in TXT file format which contains the Network Camera's public IP address in your email or on the FTP server.
4. Go to Configuration > Network > General settings > Network type. Select PPPoE and enter the user name and password provided by your ISP. Click **Save** to enable the setting.

Network type

LAN

PPPoE

User name:

Password:

Confirm password:

Enable IPv6

5. The Network Camera will reboot.

6. Disconnect the power to the Network Camera; remove it from the LAN environment.

NOTE:

- ▶ If the default ports are already used by other devices connected to the same router, the Network Camera will select other ports for the Network Camera.
- ▶ If UPnP™ is not supported by your router, you will see the following message:
Error: Router does not support UPnP port forwarding.
- ▶ Below are steps to enable the UPnP™ user interface on your computer:

Note that you must log on to the computer as a system administrator to install the UPnP™ components.

1. Go to Start, click Control Panel, then click Add or Remove Programs.

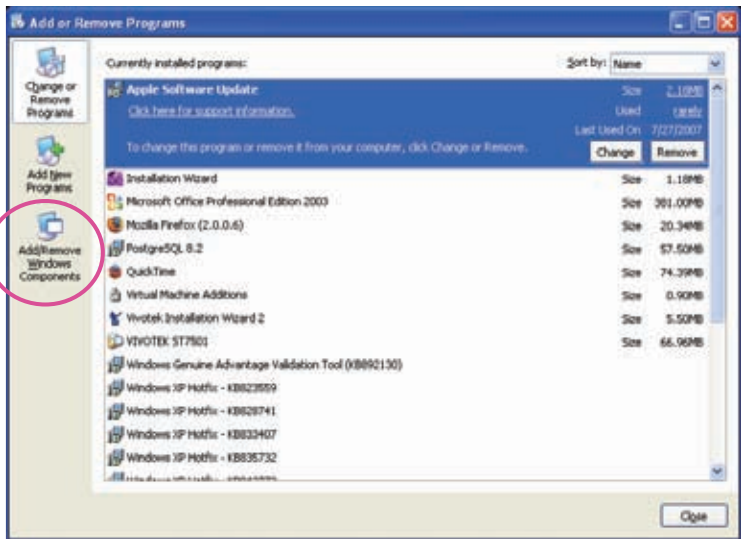
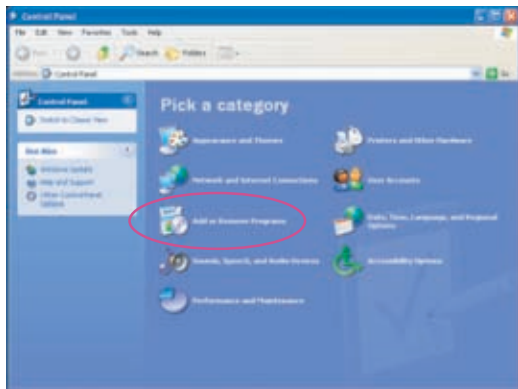

2. In the Add or Remove Programs dialog box, click Add/Remove Windows Components.

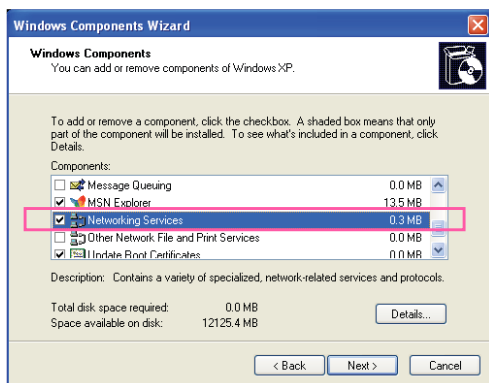

3. In the Windows Components Wizard dialog box, select Networking Services and click Details.

4. In the Networking Services dialog box, select Universal Plug and Play and click OK.

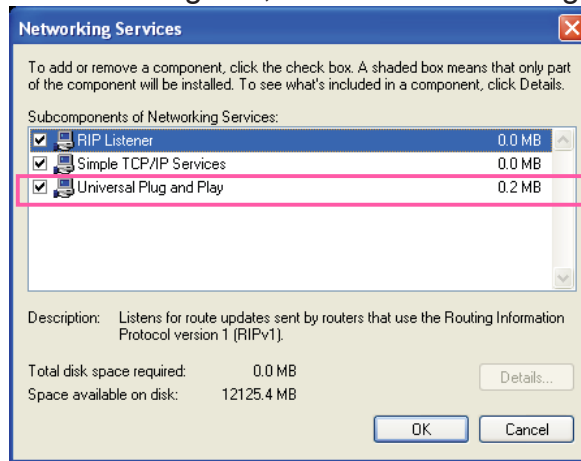

5. Click Next in the following window.

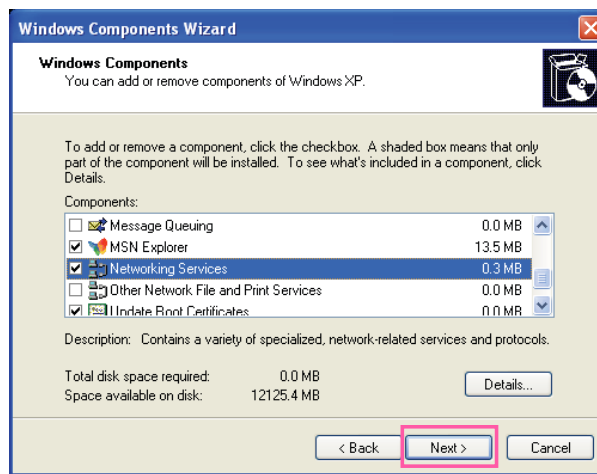

6. Click Finish. UPnP™ is enabled.

► How does UPnP™ work?

UPnP™ networking technology provides automatic IP configuration and dynamic discovery of devices added to a network. Services and capabilities offered by networked devices, such as printing and file sharing, are available among each other without the need for cumbersome network configuration. In the case of Network Cameras, you will see Network Camera shortcuts under My Network Places.

► Enabling UPnP port forwarding allows the Network Camera to open a secondary HTTP port on the router-not HTTP port-meaning that you have to add the secondary HTTP port number to the Network Camera’s public address in order to access the Network Camera from the Internet. For example, when the HTTP port is set to 80 and the secondary HTTP port is set to 8080, refer to the list below for the Network Camera’s IP address.

From the Internet	In LAN
http://203.67.124.123:8080	http://192.168.4.160 or http://192.168.4.160:8080

► If the PPPoE settings are incorrectly configured or the Internet access is not working, restore the Network Camera to factory default; please refer to Restore on page 37 for details. After the Network Camera is reset to factory default, it will be accessible on the LAN.

Enable IPv6

Select this option and click **Save** to enable IPv6 settings.

Please note that this only works if your network environment and hardware equipment support IPv6. The browser should be Microsoft® Internet Explorer 6.5, Mozilla Firefox 3.0 or above.

Network type

LAN

PPPoE

User name:

Password:

Confirm password:

Enable IPv6

[IPv6 information](#)

Manually setup the IP address

When IPv6 is enabled, by default, the network camera will listen to router advertisements and be assigned with a link-local IPv6 address accordingly.

IPv6 Information: Click this button to obtain the IPv6 information as shown below.

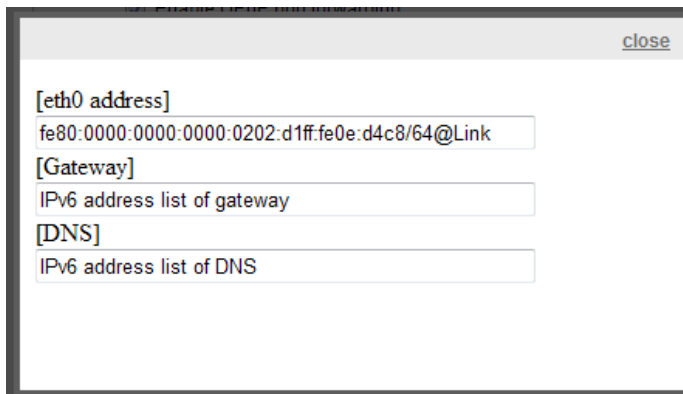

If your IPv6 settings are successful, the IPv6 address list will be listed in the pop-up window. The IPv6 address will be displayed as follows:

Refers to Ethernet

[eth0 address]	
2001:0c08:2500:0002:0202:d1ff:fe04:65f4/64@Global	— Link-global IPv6 address/network mask
fe80:0000:0000:0000:0202:d1ff:fe04:65f4/64@Link	— Link-local IPv6 address/network mask
[Gateway]	
fe80::211:d8ff:fea2:1a2b	
[DNS]	
2010:05c0:978d::	

Please follow the steps below to link to an IPv6 address:

1. Open your web browser.
2. Enter the link-global or link-local IPv6 address in the address bar of your web browser.
3. The format should be:



4. Press **Enter** on the keyboard or click **Refresh** button to refresh the webpage.
For example:

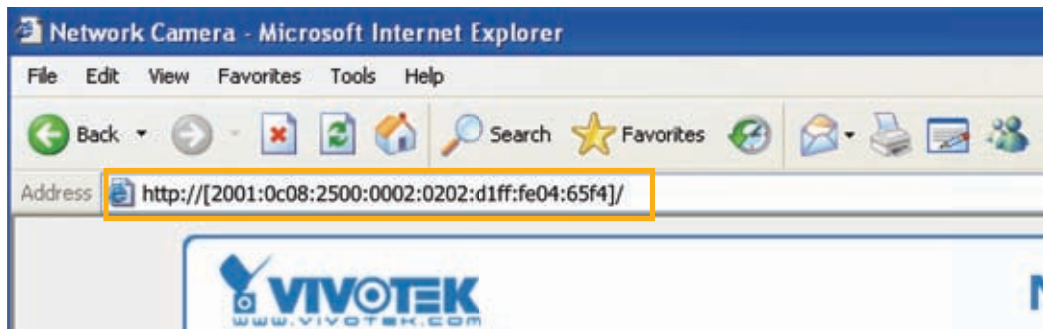

NOTE:

- ▶ If you have a Secondary HTTP port (the default value is 8080), you can also link to the webpage in the following address format: (Please refer to **HTTP** streaming on page 58 for detailed information.)



- ▶ If you choose PPPoE as the Network Type, the [PPP0 address] will be displayed in the IPv6 information column as shown below.

[eth0 address]
fe80:0000:0000:0000:0202:d1ff:fe11:2299/64@Link
[ppp0 address]
fe80:0000:0000:0000:0202:d1ff:fe11:2299/10@Link
2001:b100:01c0:0002:0202:d1ff:fe11:2299/64@Global
[Gateway]
fe80::90:1a00:4142:8ced
[DNS]
2001:b000::1

Manually setup the IP address: Select this option to manually set up IPv6 settings if your network environment does not have DHCPv6 server and router advertisements-enabled routers. If you check this item, the following blanks will be displayed for you to enter the corresponding information:

Enable IPv6

[IPv6 information](#)

Manually setup the IP address

Optional IP address / Prefix length / 64

Optional default router

Optional primary DNS

Port

Port	
HTTPS port:	<input type="text" value="443"/>
Two way audio port:	<input type="text" value="5060"/>
FTP port:	<input type="text" value="21"/>

HTTPS port: By default, the HTTPS port is set to 443. It can also be assigned to another port number between 1025 and 65535.

Two way audio port: By default, the two way audio port is set to 5060. Also, it can also be assigned to another port number between 1025 and 65535.

The Network Camera supports two way audio communication so that operators can transmit and receive audio simultaneously. By using the Network Camera’s built-in or external microphone and an external speaker, you can communicate with people around the Network Camera.





Note that as JPEG only transmits a series of JPEG images to the client, to enable the two-way audio function, make sure the video mode is set to “MPEG-4” or “H.264” on the Media > Video > Stream settings page and the media option is set to “Media > Video > Stream settings” on the Client Settings page. Please refer to Client Settings on page 26 and Stream settings on page 78.

Audio is being transmitted to the Network Camera



IMPORTANT!

The network camera does not come with an embedded microphone. An externally connected microphone is necessary, and hence the default audio is mute. If you connect a microphone, you should deselect the audio mute checkbox in Media -> Audio setting page.

Click  to enable audio transmission to the Network Camera; click  to adjust the volume of microphone; click  to turn off the audio. To stop talking, click  again.

FTP port: The FTP server allows the user to save recorded video clips. You can utilize VIVOTEK’s Installation Wizard 2 to upgrade the firmware via FTP server. By default, the FTP port is set to 21. It also can be assigned to another port number between 1025 and 65535.

Network > Streaming protocols Advanced Mode

HTTP streaming

To utilize HTTP authentication, make sure that you have set a password for the Network Camera first; please refer to Security > User account on page 40 for details.

HTTP streaming
RTSP streaming

Authentication:	<input type="text" value="basic"/>
HTTP port:	<input type="text" value="80"/>
Secondary HTTP port:	<input type="text" value="8080"/>
Access name for stream 1:	<input type="text" value="video.mjpg"/>
Access name for stream 2:	<input type="text" value="video2.mjpg"/>
Access name for stream 3:	<input type="text" value="video3.mjpg"/>
Access name for stream 4:	<input type="text" value="video4.mjpg"/>
Access name for stream 5:	<input type="text" value="videoany.mjpg"/>

Authentication: Depending on your network security requirements, the Network Camera provides two types of security settings for an HTTP transaction: basic and digest.

If **basic** authentication is selected, the password is sent in plain text format and there can be potential risks of being intercepted. If **digest** authentication is selected, user credentials are encrypted using MD5 algorithm and thus provide better protection against unauthorized accesses.

HTTP port / Secondary HTTP port: By default, the HTTP port is set to 80 and the secondary HTTP port is set to 8080. They can also be assigned to another port number between 1025 and 65535. If the ports are incorrectly assigned, the following warning messages will be displayed:

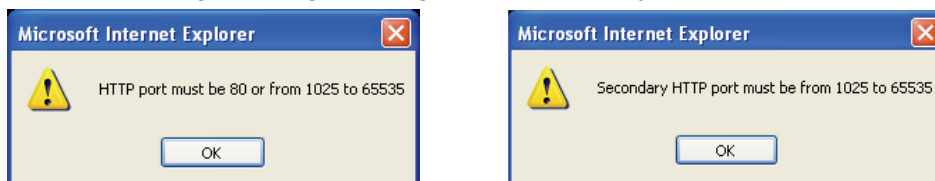

To access the Network Camera on the LAN, both the HTTP port and secondary HTTP port can be used to access the Network Camera. For example, when the HTTP port is set to 80 and the secondary HTTP port is set to 8080, refer to the list below for the Network Camera's IP address.

On the LAN

http://192.168.4.160 or
http://192.168.4.160:8080

Access name for stream 1 ~ 5: This Network camera supports multiple streams simultaneously. The access name is used to differentiate the streaming source. Users can click **Media > Video > Stream settings** to set up the video quality of linked streams. For more information about how to set up the video quality, please refer to Stream settings on page 78.

When using Mozilla Firefox or Netscape to access the Network Camera and the video mode is set to JPEG, users will receive video comprised of continuous JPEG images. This technology, known as "server push", allows the Network Camera to feed live pictures to Mozilla Firefox and Netscape.

URL command -- <http://<ip address>:<http port>/<access name for stream 1 ~ 5>>

For example, when the Access name for stream 2 is set to [video2.mjpg](#):

1. Launch Mozilla Firefox or Netscape.
2. Type the above URL command in the address bar. Press **Enter**.
3. The JPEG images will be displayed in your web browser.



NOTE:

- ▶ Microsoft® Internet Explorer does not support server push technology; therefore, using <http://<ip address>:<http port>/<access name for stream 1 ~ 5>> will fail to access the Network Camera.
- ▶ Users can only use URL commands to request the stream 5. For more information about URL commands, please refer to page 111.

RTSP Streaming

To utilize RTSP streaming authentication, make sure that you have set a password for the Network Camera first; please refer to Security > User account on page 40 for details.

HTTP streaming	RTSP streaming
	Authentication: <input type="text" value="disable"/>
	Access name for stream 1: <input type="text" value="live.sdp"/>
	Access name for stream 2: <input type="text" value="live2.sdp"/>
	Access name for stream 3: <input type="text" value="live3.sdp"/>
	Access name for stream 4: <input type="text" value="live4.sdp"/>
	Access name for stream 5: <input type="text" value="liveany.sdp"/>
	RTSP port: <input type="text" value="554"/>
	RTP port for video: <input type="text" value="5556"/>
	RTCP port for video: <input type="text" value="5557"/>
	RTP port for audio: <input type="text" value="5558"/>
	RTCP port for audio: <input type="text" value="5559"/>

Authentication: Depending on your network security requirements, the Network Camera provides three types of security settings for streaming via RTSP protocol: disable, basic, and digest.

If **basic** authentication is selected, the password is sent in plain text format, but there can be potential risks of it being intercepted. If **digest** authentication is selected, user credentials are encrypted using MD5 algorithm, thus providing better protection against unauthorized access.

The availability of the RTSP streaming for the three authentication modes is listed in the following table:

	Quick Time player	Real Player
Disable	O	O
Basic	O	O
Digest	O	X

Access name for stream 1 ~ 5: This Network camera supports multiple streams simultaneously. The access name is used to differentiate the streaming source.

If you want to use an **RTSP player** to access the Network Camera, you have to set the video mode to **H.264 / MPEG-4** and use the following RTSP URL command to request transmission of the streaming data.

rtsp://<ip address>:<rtsp port>/<access name for stream1 ~ 5>

For example, when the access name for **stream 1** is set to **live.sdp**:

1. Launch an RTSP player.
2. Choose File > Open URL. A URL dialog box will pop up.
3. Type the above URL command in the text box.
4. The live video will be displayed in your player as shown below.

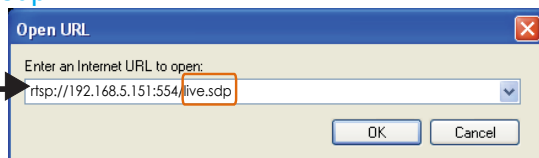

RTSP port /RTP port for video, audio/ RTCP port for video, audio

- RTSP (Real-Time Streaming Protocol) controls the delivery of streaming media. By default, the port number is set to 554.
- The RTP (Real-time Transport Protocol) is used to deliver video and audio data to the clients. By default, the RTP port for video is set to 5556 and the RTP port for audio is set to 5558.
- The RTCP (Real-time Transport Control Protocol) allows the Network Camera to transmit the data by monitoring the Internet traffic volume. By default, the RTCP port for video is set to 5557 and the RTCP port for audio is set to 5559.

The ports can be changed to values between 1025 and 65535. The RTP port must be an even number and the RTCP port is the RTP port number plus one, and thus is always an odd number. When the RTP port changes, the RTCP port will change accordingly.

If the RTP ports are incorrectly assigned, the following warning message will be displayed:

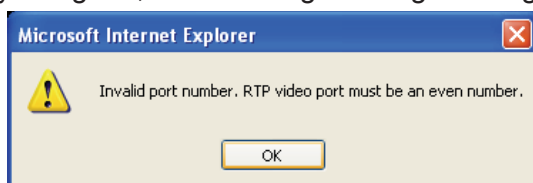

Multicast settings for stream 1 ~ 4: Click the items to display the detailed configuration information. Select the Always multicast option to enable multicast for stream 1 ~ 4.

<p>▼ Multicast settings for stream 1:</p> <p><input type="checkbox"/> Always multicast</p> <p>Multicast group address: <input type="text" value="239.128.1.99"/></p> <p>Multicast video port: <input type="text" value="5560"/></p> <p>Multicast RTCP video port: <input type="text" value="5561"/></p> <p>Multicast audio port: <input type="text" value="5562"/></p> <p>Multicast RTCP audio port: <input type="text" value="5563"/></p> <p>Multicast TTL [1~255]: <input type="text" value="15"/></p>	<p>▼ Multicast settings for stream 3</p> <p><input type="checkbox"/> Always multicast</p> <p>Multicast group address: <input type="text" value="239.128.1.101"/></p> <p>Multicast video port: <input type="text" value="5568"/></p> <p>Multicast RTCP video port: <input type="text" value="5569"/></p> <p>Multicast audio port: <input type="text" value="5570"/></p> <p>Multicast RTCP audio port: <input type="text" value="5571"/></p> <p>Multicast TTL [1~255]: <input type="text" value="15"/></p>
<p>▼ Multicast settings for stream 2:</p> <p><input type="checkbox"/> Always multicast</p> <p>Multicast group address: <input type="text" value="239.128.1.100"/></p> <p>Multicast video port: <input type="text" value="5564"/></p> <p>Multicast RTCP video port: <input type="text" value="5565"/></p> <p>Multicast audio port: <input type="text" value="5566"/></p> <p>Multicast RTCP audio port: <input type="text" value="5567"/></p> <p>Multicast TTL [1~255]: <input type="text" value="15"/></p>	<p>▼ Multicast settings for stream 4</p> <p><input type="checkbox"/> Always multicast</p> <p>Multicast group address: <input type="text" value="239.128.1.102"/></p> <p>Multicast video port: <input type="text" value="5572"/></p> <p>Multicast RTCP video port: <input type="text" value="5573"/></p> <p>Multicast audio port: <input type="text" value="5574"/></p> <p>Multicast RTCP audio port: <input type="text" value="5575"/></p> <p>Multicast TTL [1~255]: <input type="text" value="15"/></p>

Unicast video transmission delivers a stream through point-to-point transmission; multicast, on the other hand, sends a stream to the multicast group address and allows multiple clients to acquire the stream at the same time by requesting a copy from the multicast group address. Therefore, enabling multicast can effectively save Internet bandwidth.

The ports can be changed to values between 1025 and 65535. The multicast RTP port must be an even number and the multicast RTCP port number is the multicast RTP port number plus one, and thus is always odd. When the multicast RTP port changes, the multicast RTCP port will change accordingly.

If the multicast RTP video ports are incorrectly assigned, the following warning message will be displayed:

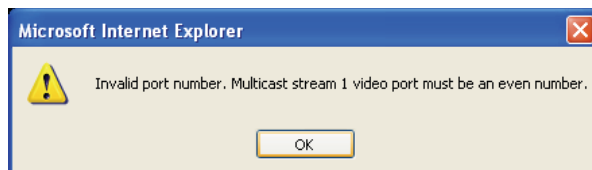

Multicast TTL [1~255]: The multicast TTL (Time To Live) is the value that tells the router the range a packet can be forwarded.

Network > QoS (Quality of Service) Advanced Mode

Quality of Service refers to a resource reservation control mechanism, which guarantees a certain quality to different services on the network. Quality of service guarantees are important if the network capacity is insufficient, especially for real-time streaming multimedia applications. Quality can be defined as, for instance, a maintained level of bit rate, low latency, no packet dropping, etc.

The following are the main benefits of a QoS-aware network:

- The ability to prioritize traffic and guarantee a certain level of performance to the data flow.
- The ability to control the amount of bandwidth each application may use, and thus provide higher reliability and stability on the network.

Requirements for QoS

To utilize QoS in a network environment, the following requirements must be met:

- All network switches and routers in the network must include support for QoS.
- The network video devices used in the network must be QoS-enabled.

QoS models

CoS (the VLAN 802.1p model)

IEEE802.1p defines a QoS model at OSI Layer 2 (Data Link Layer), which is called CoS, Class of Service. It adds a 3-bit value to the VLAN MAC header, which indicates the frame priority level from 0 (lowest) to 7 (highest). The priority is set up on the network switches, which then use different queuing disciplines to forward the packets.

Below is the setting column for CoS. Enter the **VLAN ID** of your switch (0~4095) and choose the priority for each application (0~7).

CoS

Enable CoS

VLAN ID:	<input style="width: 50px;" type="text" value="1"/>
Live video:	<input style="width: 50px;" type="text" value="0"/> ▼
Live audio:	<input style="width: 50px;" type="text" value="0"/> ▼
Event/Alarm:	<input style="width: 50px;" type="text" value="0"/> ▼
Management:	<input style="width: 50px;" type="text" value="0"/> ▼

If you assign Video the highest level, the switch will handle video packets first.



NOTE:

- ▶ A VLAN Switch (802.1p) is required. Web browsing may fail if the CoS setting is incorrect.
- ▶ Class of Service technologies do not guarantee a level of service in terms of bandwidth and delivery time; they offer a “best-effort.” Users can think of CoS as “coarsely-grained” traffic control and QoS as “finely-grained” traffic control.
- ▶ Although CoS is simple to manage, it lacks scalability and does not offer end-to-end guarantees since it is based on L2 protocol.

QoS/DSCP (the DiffServ model)

DSCP-ECN defines QoS at Layer 3 (Network Layer). The Differentiated Services (DiffServ) model is based on packet marking and router queuing disciplines. The marking is done by adding a field to the IP header, called the DSCP (Differentiated Services Codepoint). This is a 6-bit field that provides 64 different class IDs. It gives an indication of how a given packet is to be forwarded, known as the Per Hop Behavior (PHB). The PHB describes a particular service level in terms of bandwidth, queueing theory, and dropping (discarding the packet) decisions. Routers at each network node classify packets according to their DSCP value and give them a particular forwarding treatment; for example, how much bandwidth to reserve for it.

Below are the setting options of DSCP (DiffServ Codepoint). Specify the DSCP value for each application (0~63).

QoS/DSCP

Enable QoS/DSCP

Live video:	<input type="text" value="0"/>
Live audio:	<input type="text" value="0"/>
Event/Alarm:	<input type="text" value="0"/>
Management:	<input type="text" value="0"/>

Network > DDNS

This section explains how to configure the dynamic domain name service for the Network Camera. DDNS is a service that allows your Network Camera, especially when assigned with a dynamic IP address, to have a fixed host and domain name.

Express link

Express Link is a free service provided by VIVOTEK server, which allows users to register a domain name for a network device. One URL can only be mapped to one MAC address. This service will check if a host name is valid and automatically open a port on your router. Unlike DDNS, for which a user has to manually check out UPnP port forwarding, the Express Link is more convenient and easy to set up.

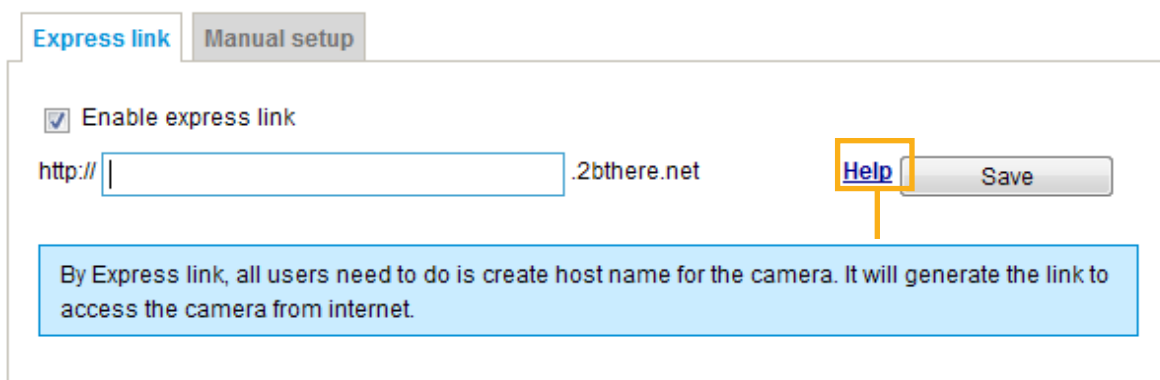

Express link Manual setup

Enable express link

http:// .2bthere.net [Help](#) Save

By Express link, all users need to do is create host name for the camera. It will generate the link to access the camera from internet.

Please follow the steps below to enable Express Link:

1. Make sure that your router supports UPnP port forwarding and it is activated, or you may see the following warning message: “**Express link is not supported under current network environment.**”
2. Select the **Enable express link** checkbox.
3. Enter a host name for the network device and click **Save**. If the host name has been used by another device, a warning message will prompt. If the host name is valid, it will show a message as shown below.



Express link Manual setup

Enable express link

http:// 0002D1123456 .2bthere.net [Help](#) Save

The camera can now be accessed at <http://0002D1123456.2bthere.net>

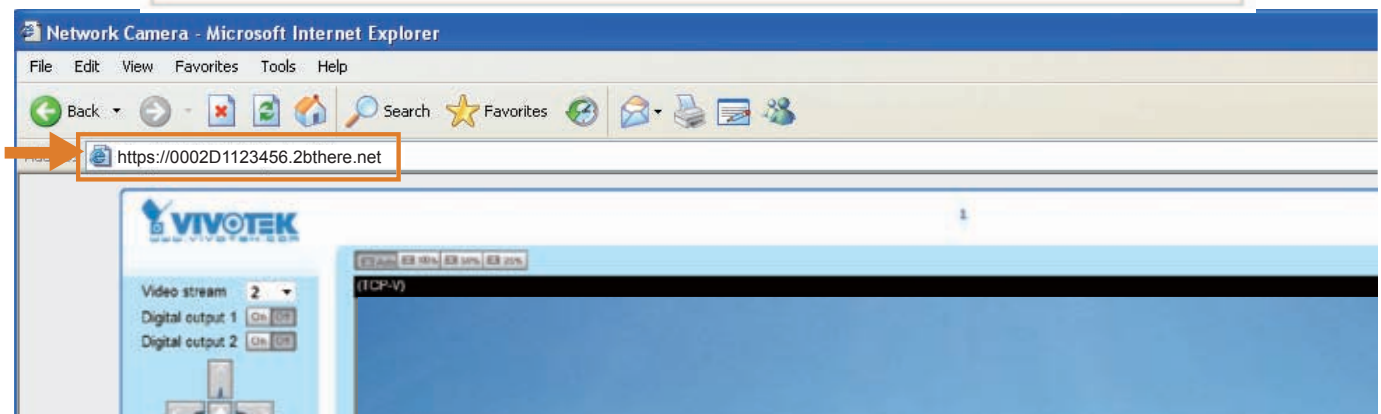

Manual setup

DDNS: Dynamic domain name service

Enable DDNS: Select this option to enable the DDNS setting.

Provider: Select a DDNS provider from the provider drop-down list.

VIVOTEK offers [Safe100.net](#), a free dynamic domain name service, to VIVOTEK customers. It is recommended that you register [Safe100.net](#) to access VIVOTEK's Network Cameras from the Internet. Additionally, we offer other DDNS providers, such as Dyndns.org(Dynamic), Dyndns.org(Custom), TZO.com, DHS.org, CustomSafe100, dyn-interfree.it.

Note that before utilizing this function, please apply for a dynamic domain account first.

■ [Safe100.net](#)

1. In the DDNS column, select [Safe100.net](#) from the drop-down list. Click **I accept** after reviewing the terms of the Service Agreement.
2. In the Register column, fill in the Host name (xxxx.safe100.net), Email, Key, and Confirm Key, and click **Register**. After a host name has been successfully created, a success message will be displayed in the DDNS Registration Result column.

3. Click **Copy** and all the registered information will automatically be uploaded to the corresponding fields in the DDNS column at the top of the page as seen in the picture.

DDNS: Dynamic domain name service

Enable DDNS

Provider:

Host name: [*safe100.net]

Email:

Key:

Register

Host name:

Email:

Key:

Confirm key:

To apply for a domain name for the camera, or to modify the previously registered information, fill in the following fields and then click "Register".

DDNS registration result

Upon successful registration, you can click [copy](#) to automatically upload relevant information to the DDNS form or you can manually fill it in. Then, click "Save" to save new settings.

4. Select Enable DDNS and click **Save** to enable the setting.

■ CustomSafe100

VIVOTEK offers documents to establish a CustomSafe100 DDNS server for distributors and system integrators. You can use CustomSafe100 to register a dynamic domain name if your distributor or system integrators offer such services.

1. In the DDNS column, select CustomSafe100 from the drop-down list.
2. In the Register column, fill in the Host name, Email, Key, and Confirm Key; then click **Register**. After a host name has been successfully created, you will see a success message in the DDNS Registration Result column.
3. Click **Copy** and all for the registered information will be uploaded to the corresponding fields in the DDNS column.
4. Select Enable DDNS and click **Save** to enable the setting.

Forget key: Click this button if you have forgotten the key to Safe100.net or CustomSafe100. Your account information will be sent to your email address.

Refer to the following links to apply for a dynamic domain account when selecting other DDNS providers:

- [Dyndns.org\(Dynamic\) / Dyndns.org\(Custom\)](http://www.dyndns.com/): visit <http://www.dyndns.com/>
- [TZO.com](http://www.tzo.com/): visit <http://www.tzo.com/>
- [DHS.org](http://www.dns.org/): visit <http://www.dns.org/>
- dyn-interfree.it: visit <http://dyn-interfree.it/>

Network > SNMP (Simple Network Management Protocol)

Advanced Mode

This section explains how to use the SNMP on the network camera. The Simple Network Management Protocol is an application layer protocol that facilitates the exchange of management information between network devices. It helps network administrators to remotely manage network devices and find, solve network problems with ease.

■ The SNMP consists of the following three key components:

1. Manager: Network-management station (NMS), a server which executes applications that monitor and control managed devices.
2. Agent: A network-management software module on a managed device which transfers the status of managed devices to the NMS.
3. Managed device: A network node on a managed network. For example: routers, switches, bridges, hubs, computer hosts, printers, IP telephones, network cameras, web server, and database.

Before configuring SNMP settings on the this page, please enable your NMS first.

SNMP Configuration

Enable SNMPv1, SNMPv2c

Select this option and enter the names of Read/Write community and Read Only community according to your NMS settings.

Enable SNMPv1, SNMPv2c

SNMPv1, SNMPv2c Settings

Read/Write community:

Read only community:

Enable SNMPv3

This option contains cryptographic security, a higher security level, which allows you to set the Authentication password and the Encryption password.

- Security name: According to your NMS settings, choose Read/Write or Read Only and enter the community name.
- Authentication type: Select MD5 or SHA as the authentication method.
- Authentication password: Enter the password for authentication (at least 8 characters).
- Encryption password: Enter a password for encryption (at least 8 characters).

Enable SNMPv3

SNMPv3 Settings

Read/Write Security name:

Authentication Type:

Authentication Password:

Encryption Password:

Read only Security name:

Authentication Type:

Authentication Password:

Encryption Password:

Media > Image Advanced Mode

This section explains how to configure the image settings of the Network Camera. It is composed of the following four tabbed menus: General settings, Preference, Exposure, and Privacy mask.

General settings

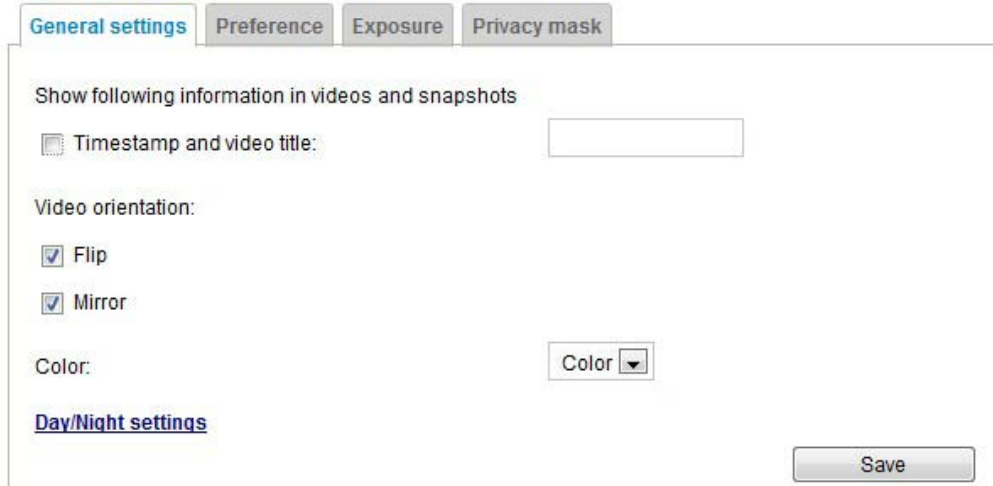

Timestamp and video title: Enter a name that will be displayed on the title bar of the live video as the picture shown below.



Video orientation: Flip--vertically reflect the display of the live video; Mirror--horizontally reflect the display of the live video. Select both options if the Network Camera is installed upside-down (e.g., on the ceiling) to correct the image orientation. Please note that the preset locations will be cleared after you change the flip/mirror setting.

Color: Select to display color or black/white video streams.

Day/Night Settings

The Day/Night related settings has been moved to the Exposure page. A hyperlink is provided instead. Refer to the following discussions for its details.

Preference

On this page, you can tune the White balance, Image adjustment and individual image profile settings. You can configure two sets of preference settings: one for normal situations, the other for special situations, such as day/night/schedule mode.

General settings Preference Exposure Privacy mask

(UDP-V) 2011/9/5 11:37:03

White balance
Auto Fix current value

Image adjustment

Brightness:

Contrast:

Sharpness:

Profile Preview Restore Save

For normal situations
Sensor Setting 1:

Sensor Setting 2:
For special situations

White balance: Adjust the value for the best color temperature.

- **Auto**: It will automatically adjust the color temperature of the light in response to different light sources. You may follow the steps below to adjust the white balance to the best color temperature.
 1. Set the White balance to **Auto**.
 2. Place a sheet of white paper in front of the lens, then allow the Network Camera to adjust the color temperature automatically.
 3. Check **Fix current value** to confirm the setting while the white balance is being measured.
- **Manual**: This item allows users to manually tune the R gain & B gain values.

Image Adjustment

- **Brightness**: Adjust the image brightness level, which ranges from -5 to +5.
- **Contrast**: Adjust the image contrast level, which ranges from -5 to +5. Please note that this function will be disabled if you enable WDR enhancement in the next column.

- **Sharpness:** Adjust the image sharpness level, which ranges from -3 to +3. You can also select **Customize** and manually enter a value.

If you want to configure another sensor setting for day/night/schedule mode, please click **Profile** to open the Profile Settings page as shown below.

> Profile of image settings

(UDP-V) 2011/9/5 11:45:24



General settings

Enable and apply this profile to

Day mode
 Night mode
 Schedule mode

White balance

Auto ▼ Fix current value

Image adjustment

Brightness: -
-
○
+
 +

Contrast: -
-
○
+
 +

Sharpness: -
-
○
+
 +

Preview
Restore
Close
Save

Please follow the steps below to setup a profile:

1. Check **Enable and apply this profile**.
2. Select the applied mode: Day mode, Night mode, or Schedule mode. Please manually enter a range of time if you choose the Schedule mode.
3. Configure the settings in the following columns.
4. Click **Save** to enable the settings and click **Close** to exit the page.

Exposure Advanced Mode

On this page, you can set the Exposure level, Exposure mode, Exposure time, Iris, and Gain control settings. You can configure two sets of Exposure settings: one for normal situations, the other for special situations, such as day/night/schedule mode.

General settings Preference **Exposure** Privacy mask

(UDP-V) 2011/9/5 11:49:50

Exposure control

Exposure level: 0.3

Automatic gain control: 6 db 28 db 14 db

Exposure mode: Manual

Exposure time: 1/10000 1/100 1/1 1/60

Iris adjustment: F22 F1.35 F2.8

Gain control: 0 db 28 db 8 db

WDR

Mode: Off

Day/Night

IR cut filter: Day mode

IR light detection

EIS

Enable image stabilizer

Profile Save

Sensor Setting 1:
For normal situations

Sensor Setting 2:
For special situations

Before you start tuning the exposure related settings, please note that each Exposure mode contains different configurable features. The options are shown below:

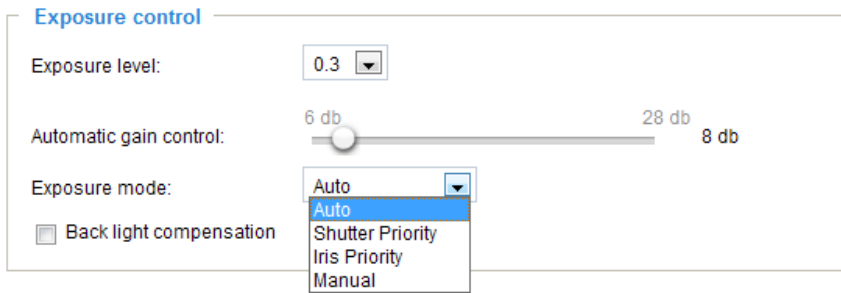

Exposure modes	Configurable features
Auto	> Back light compensation
Shutter Priority	> Exposure time
Iris Priority	> Iris adjustment
Manual	> Exposure time
	> Iris adjustment
	> Gain control

Exposure control:

- Exposure level: You can manually set the Exposure level, which ranges from -2.0 to +2.0 (dark to bright).
- Automatic gain control: Selects the reasonable gain value to maintain a good picture. Note that the gain level, lighting levels and picture performance are closely related.
- Exposure mode: Select **Auto**, **Shutter Priority**, **Iris Priority**, or **Manual** mode according to your needs. For example, if the camera aims to monitor fast moving objects such as traffic control, you might utilize the Shutter Priority mode. Then, tune the slide bar to set the Exposure time and Gain Control to the best image quality.

■ Auto Mode:

- Back Light Compensation (only available with the Auto mode): This option will automatically adjust the display of images according to the brightness of an object which is at the center of a camera’s focus.

If you select the **Auto mode**, the Exposure time and Iris adjustment will be not configurable since the sensor library will automatically adjust the value according to the ambient light.

■ Shutter Priority:

- Exposure time: The Exposure time setting allows tuning for more or less light into the lens. The configurable value ranges from 1/10000 to the longest 1/1 second. An optimum shutter speed should be maintained as long as the light level of the scene permits.

■ Iris Priority:

- Iris adjustment: The value is measured in the F-number as the ratio of the focal length to the lens diameter. Iris size is inversely proportional to the F-number; therefore, the smaller the F-number, the greater is the exposure ratio. Smaller F-number (larger exposure ratio, largest size of lens aperture opening) is shown on the right of the slide bar.

■ Manual: (the Manual mode enables access to the configurable features above)

- Exposure time: see above for description.
- Iris Adjustment: see above for description.

- Gain control: see above for description.

WDR (Wide Dynamic Range): This function allows users to identify more image details in an environment with dark objects posed against an extremely bright background. You may enable the function by selecting Auto or the Manual mode, and then adjust the sensitivity and correction level (low, medium, high) to acquire the best image quality.

WDR		WDR	
Mode:	Auto	Mode:	Manual
Sensitivity:	Low	Strength:	Low
Strength:	Low	Long exposure:	1/60s
		Short exposure:	1/4500



NOTE:

This camera supports Double exposure in the WDR mode. Double exposure is an advanced firmware algorithm that delivers best image quality by comparing two video frames taken with different shutter speeds, e.g., 1/60s and 1/4500s, and rendering data points from them into a well-balanced image. Note that if this feature is enabled, the camera's video frame rate will be halved, e.g., from 60fps to 30fps. With frames taken at two different shutter speeds, the Long exposure is always set at 1/60s, while the Short exposure value is user-configurable depending on the lighting condition of where the camera is deployed.

When completed with the settings on this page, click **Save** to enable the setting.

Please follow the steps below to setup a profile:

1. Check **Enable and apply this profile**.
2. Select the applied mode: Day mode, Night mode, or Schedule mode. Please manually enter a range of time if you choose the Schedule mode.
3. Configure Exposure control settings in the following columns.
4. Click **Save** to enable the setting and click **Close** to exit the page.

If you want to configure another sensor setting for day/night/schedule mode, please click **Profile** to open the Profile settings page as shown below. For instance, you will need a longer exposure time for a night-time vision

For configuration details in this window, please refer to the previous discussions.

>Profile of exposure settings



Activated period

Enable and apply this profile to

- Day mode
- Night mode
- Schedule mode

Exposure control

Exposure level: 0

Automatic gain control: 6 db ————— 28 db 14 db

Exposure mode: Auto

Back light compensation

WDR

Mode: Off

Day/Night

IR cut filter: Auto mode

Sensitivity of IR cut filter: High ————— Low

IR light detection

EIS

Enable image stabilizer

Close Save

Day/Night Settings

The screenshot displays two panels for Day/Night settings. The top panel, titled 'Day/Night', has a dropdown menu for 'IR cut filter' set to 'Auto mode'. Below it is a slider for 'Sensitivity of IR cut filter' with 'High' on the left and 'Low' on the right. A checkbox for 'IR light detection' is present and unchecked. The bottom panel, also titled 'Day/Night', has a dropdown menu for 'IR cut filter' set to 'Schedule mode'. Below it, 'Day mode' is set to 'From 06:00 to 18:00 [hh:mm]'. A checkbox for 'IR light detection' is present and unchecked. A red double-headed vertical arrow is positioned between the two panels, indicating a toggle or relationship between the 'Auto mode' and 'Schedule mode' options.

IR cut filter

With a removable IR-cut filter, this Network Camera can automatically remove the filter to let IR light into the sensor during low light conditions.

- **Auto mode**
The Network Camera automatically removes the filter by judging the level of ambient light where its sensitivity can be altered.
- **Day mode**
In day mode, the Network Camera switches on the IR cut filter at all times to block infrared light from reaching the sensor so that the colors will not be distorted.
- **Night mode**
In the night mode, the Network Camera switches off its IR cut filter at all times for the sensor to capture infrared light, thus helping to improve low light sensitivity.
- **Schedule mode**
The Network Camera switches between day mode and night mode based on a specified schedule. Enter the start and end time for day mode. Note that the time format is [hh:mm] and is expressed in 24-hour clock time. By default, the start and end time of day mode are set to 07:00 and 18:00.



NOTE:

1. When set to Night mode, the image display automatically changes to Black and White.
2. There is no Preview button in the Exposure window. Configuration changes are directly reflected on the live view window.

IR light detection

A speed dome camera often needs to capture images hundreds of meters away. As the result, external IR lights are rarely implemented with a speed dome camera for their effective range is shorter. However, if you do implement an external IR light, it is recommended to select this checkbox. The IR light detection function's default is "off."

Enabling this function allows the camera module to distinguish visible and infrared lights, so that the camera module does not mistakenly enter Day mode when the surrounding environment is well-lighted by an external IR light.

EIS (Electronic image stabilization): Vibrations are almost unavoidable for speed dome cameras which are often installed on a high pole mount. In places like airports or train stations vibrations can come from wind or heavy traffic, and can cause troubles when zooming in on a target. The EIS compensation filters reduce the effects of vibration movements and helps create a sharper image.

EIS Enable image stabilizer

Privacy mask Advanced Mode

Click **Privacy Mask** to open the settings page. On this page, you can block out certain sensitive zones to address privacy concerns.



To set the privacy mask windows, follow the steps below:

1. Use the keypad on the upper right to look for a target that will be masked. You may also use mouse clicks on the screen or your joystick to move around. Use the **Go to** menu to quickly select a preset position.
2. Place your cursor on the rim of the hollow square to change the size of the masking window. It is recommended to be at least twice the size of the object (height and width) to be masked.
3. Click on the **Enable privacy mask** checkbox to display the drop-down menus.
4. Select a color for the mask from the **Color** menu. The masking color will appear when the configuration is done.
5. Enter a Window Name and click **Add** to enable the setting.

To modify or remove an existing mask window, select the window from the **Privacy mask** menu, and then click on the **Modify** or **Delete** buttons.



NOTE:

Up to 24 privacy mask windows can be configured on the same screen.

Media > Video

Stream settings Advanced Mode

Stream settings

- ✦ Video settings for stream 1
- ✦ Video settings for stream 2
- ✦ Video settings for stream 3
- ✦ Video settings for stream 4

This Network Camera supports multiple streams with frame size ranging from QCIF to D1 (in PAL and NTSC).

Click on individual stream number to display the detailed information.

✦ Video settings for stream 1

MPEG-4
 H.264

Frame size:

Maximum frame rate:

Intra frame period:

Video quality

Constant bit rate:
 Fixed quality:

JPEG

✦ Video settings for stream 2

MPEG-4
 H.264
 JPEG

Frame size:

Maximum frame rate:

Video quality:

✦ Video settings for stream 3

MPEG-4
 H.264

Frame size:

Maximum frame rate:

Intra frame period:

Video quality

Constant bit rate:
 Fixed quality:

JPEG

✦ Video settings for stream 4

MPEG-4
 H.264

Frame size:

Maximum frame rate:

Intra frame period:

Video quality

Constant bit rate:
 Fixed quality:

JPEG

This Network Camera offers real-time H.264, MPEG-4 and MJPEG compression standards (Triple Codec) for real-time viewing.

If **H.264 / MPEG-4** mode is selected, the video is streamed via RTSP protocol. There are four parameters for you to adjust the video performance:

Video settings for stream 1

MPEG-4
 H.264
 JPEG

Frame size:

Maximum frame rate:

Intra frame period:

Video quality

 Constant bit rate:

 Fixed quality:

■ Frame size

You can set up different video resolutions for different viewing devices. For example, set a smaller frame size and lower bit rate for remote viewing on mobile phones and a larger video size and a higher bit rate for live viewing on web browsers. Note that a larger frame size takes up more bandwidth.

■ Maximum frame rate

This limits the maximum refresh frame rate per second. Set the frame rate higher for smoother video quality.

■ Intra frame period

Determine how often to plant an I frame. The shorter the duration, the more likely you will get better video quality, but at the cost of higher network bandwidth consumption. Select the intra frame period from the following durations: 1/4 second, 1/2 second, 1 second, 2 seconds, 3 seconds, and 4 seconds.

■ Video quality

A complex scene generally produces a larger file size, meaning that higher bandwidth will be needed for data transmission. Therefore, if Constant bit rate is selected, the bandwidth utilization is fixed at a selected level, resulting in mutable video quality performance. The bit rates are selectable at the following rates: 20Kbps, 30Kbps, 40Kbps, 50Kbps, 64Kbps, 128Kbps, 256Kbps, 512Kbps, 768Kbps, 1Mbps, 2Mbps, 3Mbps, 4Mbps, 6Mbps, and 8Mbps. You can also select Customize and manually enter a value.

On the other hand, if Fixed quality is selected, all frames are transmitted with the same quality; bandwidth utilization is therefore unpredictable. The video quality can be adjusted to the following settings: Medium, Standard, Good, Detailed, and Excellent. You can also select Customize and manually enter a value.

If **JPEG** mode is selected, the Network Camera continuously sends JPEG images to the client, producing a moving effect similar to a filmstrip. Every single JPEG image transmitted guarantees the same image quality, which in turn comes at the expense of variable bandwidth usage. Because the media contents are a combination of JPEG images, no audio data is transmitted to the client. There are three parameters provided in MJPEG mode to control the video performance:

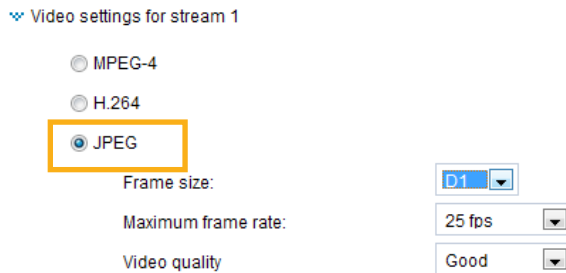

■ Frame size

You can set up different video resolution for different viewing devices. For example, set a smaller frame size and lower bit rate for remote viewing on mobile phones and a larger video size and a higher bit rate for live viewing on web browsers. Note that a larger frame size takes up more bandwidth.

■ Maximum frame rate

This limits the maximum refresh frame rate per second. Set the frame rate higher for smoother video quality.

If the power line frequency is set to 50Hz, the frame rates are selectable at 1fps, 2fps, 3fps, 5fps, 8fps, 10fps, 15fps, 20fps, 25fps, and 50fps. If the power line frequency is set to 60Hz, the frame rates are selectable at 1fps, 2fps, 3fps, 5fps, 8fps, 10fps, 15fps, 20fps, 25fps, 30fps, and 60fps. You can also select **Customize** and manually enter a value. The frame rate will decrease if you select a higher resolution.

■ Video quality

The video quality can be adjusted to the following settings: Medium, Standard, Good, Detailed, and Excellent. You can also select **Customize** and manually enter a value.



NOTE:

- Video quality and fixed quality refer to the compression rate, therefore, a lower value produces higher quality.
- Converting high-quality video may significantly increase the CPU load, and you may encounter streaming disconnections or video loss while capturing a complicated scene. In the event of occurrence, we suggest you customize to a lower video resolution or reduce the frame rate to obtain smooth video.

Media > Audio

Audio Settings

Audio settings

Mute

External microphone input gain: 1 100

Audio type

AAC bit rate: 16 Kbps ▾

GSM-AMR bit rate: 12.2 Kbps ▾

G.711: pcmu ▾

Mute: Select this option to disable audio transmission from the Network Camera to all clients. Note that if mute mode is turned on, no audio data will be transmitted even if audio transmission is enabled on the Client Settings page. In that case, the following message is displayed:

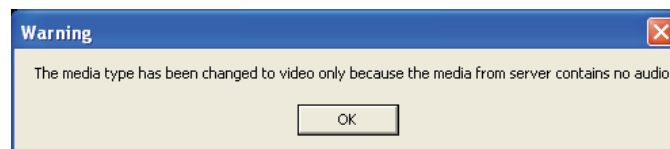

External microphone input gain: Select the acoustic input gain measurement control over the external audio input according to ambient conditions. Adjust the gain from 1 to 100 (most sensitive).

Audio type: Select audio codec AAC or GSM-AMR and the bit rate .

- AAC provides good sound quality at the cost of higher bandwidth and CPU computation power. The bit rates are selectable from: 16Kbps, 32Kbps, 48Kbps, 64Kbps, 96Kbps, and 128Kbps.
- GSM-ARM is designed to optimize speech quality and requires less bandwidth. The bit rates are selectable from: 4.75Kbps, 5.15Kbps, 5.90Kbps, 6.7Kbps, 7.4Kbps, 7.95Kbps, 10.2Kbps, and 12.2Kbps.
- G.711 also provides good sound quality and requires about 64Kbps. Select pcmu (μ -Law) or pcma (A-Law) mode.

When completed with the settings on this page, click **Save** to enable the settings.

PTZ > PTZ settings Advanced Mode

This section explains how to control the Network Camera's Pan/Tilt/Zoom operation. The camera comes with built-in PTZ mechanisms.

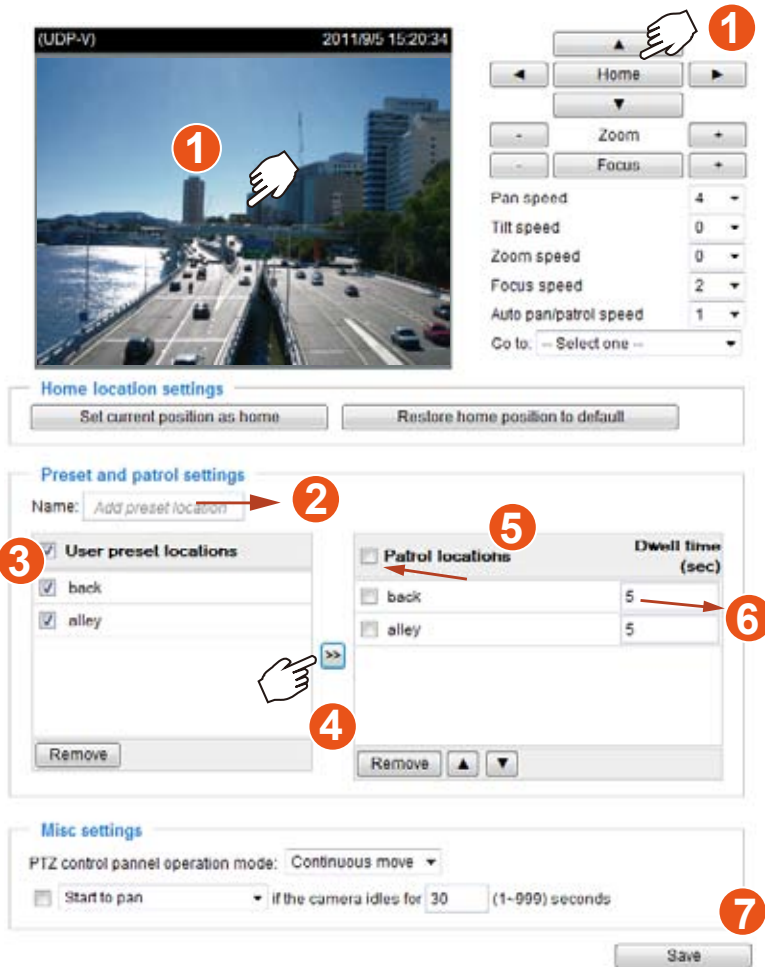

Preset positions and patrol settings

In the PTZ settings page, you can select preset positions for the camera to patrol. A total of 128 preset positions can be configured.

Please follow the steps below to configure preset positions and arrange them in a pan/tilt/zoom tour:

1. Adjust the shooting area to the desired position using the keypad on the upper right side of the window. The default **Home** position refers to the center position defaulted in the factory. You might as well select another area of interest as the "Home" position. You should also select the speeds for the actions that occur during the patrol; i.e., pan, tilt, zoom, focus, and the auto pan/patrol.
2. Enter a name for a new preset position, which can contain up to forty characters. Click **Add** to enable the settings. The preset positions will be listed on the **User preset locations**. (To add positions you wish, please repeat steps 1~2.)
3. Select the preset positions and click on the **Save** button at the bottom of the screen.
4. Click on the move button (>>) >> to move positions to the Patrol locations window.
5. You may select some or all of the imported positions as the stop points during the tour.
6. Enter a preferred dwell time before moving to the next position.
7. Click on the **Save** button to preserve your configuration.

To remove a preset position from the list, select it and click **Remove**.

You can re-arrange the patrol order of the positions on the list using the buttons.

Misc. settings:

1. PTZ control panel operation mode: **Continuous move** - click and hold down the left mouse button on the PTZ panel, and the live view will continuously move toward the preferred direction until you let go of the mouse button. The **Click to move** option allows you to move live view window one step by each single click.
2. Start to pan/patrol/return to home position: Use the checkbox and the pull-down menus for the camera to automatically pan, patrol, or return to the home position after the camera has stayed idle for a period of time.

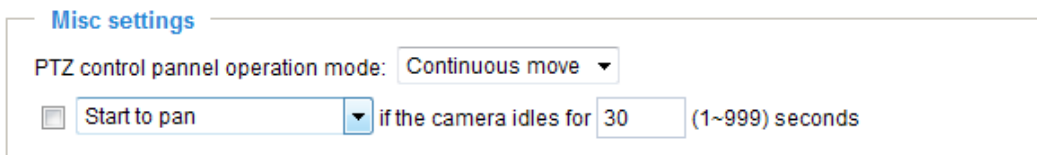

Positions on the Home page

The **Preset positions** will also be displayed on the home page. Select one from the Go to drop-down list, and the Network Camera will move to the selected preset position.

Patrol button: Click this button, then the Network Camera will patrol continuously among the selected positions.



PTZ > Calibrate

This function re-calibrates the home position to the default center to recover any displacement caused by external forces. Please note that there is no confirm message after using the function, and the calibration immediately takes place. If, after a long use, a user finds it is difficult to move camera's field of view to a specific point, use this function to restore the camera's original coordinates in pan and tilt motions.

PTZ > Calibrate

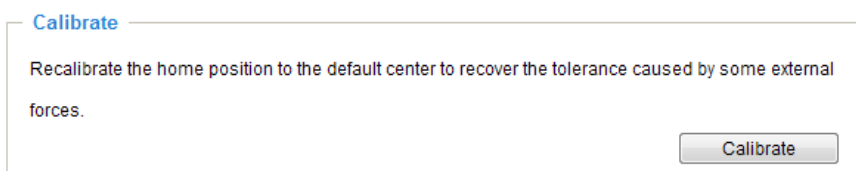

Event > Event settings Advanced Mode

This section explains how to configure the Network Camera to respond to particular situations (event). A typical application is that when a motion is detected, the Network Camera sends buffered images to an FTP server or e-mail address as notifications. Click on **Help**, there is an illustration shown in the pop-up window explaining that an event can be triggered by many sources, such as motion detection or external digital input devices. When an event is triggered, you can specify what type of action that will be performed.

The screenshot shows the 'Event' settings window. At the top, there is a table with columns: Name, Status, Sun, Mon, Tue, Wed, Thu, Fri, Sat, Time, and Trigger. Below the table are two buttons: 'Add' and 'Help'. The 'Help' button is highlighted with a yellow box. A callout window is open, showing a diagram titled 'Event Trigger' with an arrow pointing to 'Action (What to do)'. Below this, there are two sub-sections: 'Media (What to send)' and 'Server (Where to send)'. The 'Media' section lists examples like Snapshot, Video Clip, System log, and Digital Output. The 'Server' section lists examples like Email, FTP, HTTP Server, and Network storage.

Event

An event is an action initiated by a user-defined trigger source. In the **Event** column, click **Add** to open the event settings window.

The screenshot shows the 'Event' settings configuration window. At the top, there is a table with columns: Name, Status, Sun, Mon, Tue, Wed, Thu, Fri, Sat, Time, and Trigger. Below the table are two buttons: 'Add' and 'Help'. The 'Add' button is highlighted with a yellow box. The configuration window is open, showing the following fields and options:

- Event name:
- Enable this event
- Priority:
- Detect next motion detection or digital input after second(s).
- Event schedule**
 - Sun Mon Tue Wed Thu Fri Sat
 - Time**
 - Always
 - From to [hh:mm]
- Flowchart on the left: 1. Schedule → 2. Trigger → 3. Action
- Buttons at the bottom:

- **Event name:** Enter a name for the event setting.
- **Enable this event:** Select this option to enable the event setting.
- **Priority:** Select the relative importance of this event (High, Normal, or Low). Events with a higher priority setting will be executed first.
- **Detect next event after seconds:** Enter the duration in seconds to pause motion detection or digital input after a motion is detected.

Follow steps 1 to 3 to arrange the three elements -- Schedule, Trigger, and Action to configure an action to take when an event is triggered. You can configure 3 event-triggered conditions.

1. Schedule

Specify the period of time for the event-triggering function to take effect. Please select the days of the week and the time in a day (in 24-hr time format) for the recording schedule.

2. Trigger

This is the cause or stimulus which defines when to trigger the Network Camera. The trigger source can be configured to use the Network Camera's built-in motion detection mechanism or external digital input devices.

There are several choices of trigger sources as shown on next page. Select the item to display the detailed configuration options.

- **Video motion detection**
This option makes use of the built-in motion detection mechanism as a trigger source. To enable this function, you need to configure a Motion Detection Window first. For more information, please refer to Motion Detection on page 97 for details.

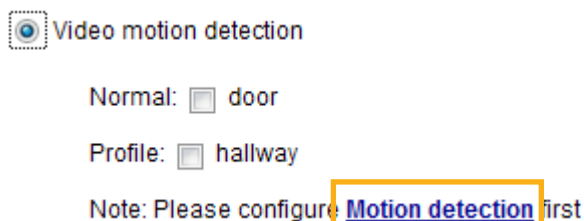

- **Periodically**
This option allows the Network Camera to trigger periodically for every other defined minute. Up to 999 minutes are allowed.

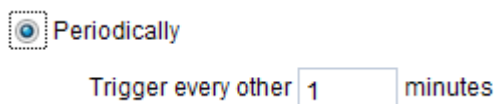

- **Digital input**
This option allows the Network Camera to use an external digital input device or sensor as a trigger source. Depending on your application, there are many choices of digital input devices on the market which helps to detect changes in temperature, vibration, sound, and light, etc.
- **System boot**
This option triggers the Network Camera when the power to the Network Camera is disconnected.
- **Recording notify**
This option allows the Network Camera to trigger when the recording disk is full or when recording starts to rewrite older data.

■ Audio detection

Audio input from an external microphone can also be configured as a triggering source. You can configure a trigger as the audio input exceeds or falls below a preset threshold. If you have not configured an audio threshold, click the link below to move to the audio detection page. Refer to page 101 for information on Audio detection.

3. Action

Define the actions to be performed by the Network Camera when a trigger is activated.

- Trigger digital output for seconds
Select this option to turn on the external digital output device when a trigger is activated. Specify the length of the trigger interval in the text box.
- Backup media if the network is disconnected
Select this option to backup media file to SD card if a network storage is disconnected. Please note that this function will be displayed when you set up a means for transporting data over the network (NAS, FTP, HTTP, or Email added as a media server). For more information about how to set up network storage, please refer to page 105.
- Move to preset location
Select a preset location you've configured. Note that please configure PTZ **Preset locations** first. For detailed information, please refer to page 83.

To set an event with recorded video or snapshots, it is necessary to configure the server and media settings so that the Network Camera will know what action to take (such as which server to send the media files to) when a trigger is activated.

Add server

Click **Add server** to unfold the server setting window. You can specify where the notification messages are sent when a trigger is activated. A total of 5 server settings can be configured.

There are four choices of server types available: Email, FTP, HTTP, and Network storage. Select the item to display the detailed configuration options. You can configure either one or all of them.

Server type - Email

Select to send the media files via email when a trigger is activated.

- Server name: Enter a name for the server setting.
- Sender email address: Enter the email address of the sender.
- Recipient email address: Enter the email address of the recipient.
- Server address: Enter the domain name or IP address of the email server.
- User name: Enter the user name of the email account if necessary.
- Password: Enter the password of the email account if necessary.
- Server port: The default mail server port is set to 25. You can also manually set another port.

If your SMTP server requires a secure connection (SSL), check **This server requires a secure connection (SSL)**.

To verify if the email settings are correctly configured, click **Test**. The result will be shown in a pop-up window. If successful, you will also receive an email indicating the result.



Click **Save server** to enable the settings, then click **Close** to exit the Add server page.

After you set up the first event server, a new item for event server will automatically show up on the Server list. If you wish to add more server options, click **Add server**.

Server	Media	Extra parameter
<input type="checkbox"/> SD	----None----	SD test View
<input type="checkbox"/> Email	----None----	
Add server		Add media

Server type - FTP

Select to send the media files to an FTP server when a trigger is activated.

[Add server](#)
[Add media](#)

Server name:

Server type

Email

FTP

Server address:

Server port:

User name:

Password:

FTP folder name:

Passive mode

HTTP

Network storage

Test
Close
Save server

- Server name: Enter a name for the server setting.
- Server address: Enter the domain name or IP address of the FTP server.
- Server port: By default, the FTP server port is set to 21. It can also be assigned to another port number between 1025 and 65535.
- User name: Enter the login name of the FTP account.
- Password: Enter the password of the FTP account.
- FTP folder name
Enter the folder where the media file will be placed. If the folder name does not exist, the Network Camera will create one on the FTP server.

■ Passive mode

Most firewalls do not accept new connections initiated from external requests. If the FTP server supports passive mode, select this option to enable passive mode FTP and allow data transmission to pass through the firewall.

To verify if the FTP settings are correctly configured, click **Test**. The result will be shown in a pop-up window as shown below. If successful, you will also receive a test.txt file on the FTP server.



Click **Save server** to enable the settings, then click **Close** to exit the Add server page.

Server type - HTTP

Select to send the media files to an HTTP server when a trigger is activated.

- Server name: Enter a name for the server setting.
- URL: Enter the URL of the HTTP server.
- User name: Enter the user name if necessary.
- Password: Enter the password if necessary.

To verify if the HTTP settings are correctly configured, click **Test**. The result will be shown in a pop-up window as below. If successful, you will receive a test.txt file on the HTTP server.



Click **Save server** to enable the settings and click **Close** to exit the Add server page.

Network storage:

Select to send the media files to a network storage location when a trigger is activated. Please refer to **NAS server** on page 105 for details.

Click **Save server** to enable the settings, then click **Close** to exit the Add server page.

Action

Trigger digital output for seconds

Backup media if the network is disconnected

Move to preset location: ▼

Note: Please configure [Preset locations](#) first

Server	Media	Extra parameter
<input type="checkbox"/> SD	-----None----- -----None-----	SD test View
<input type="checkbox"/> Email	Snapshot Video clip System log	
<input type="checkbox"/> FTP	-----None-----	
<input type="checkbox"/> HTTP	-----None-----	
<input type="checkbox"/> NAS	-----None-----	<input type="checkbox"/> Create folders by date time and hour automatically View

▼ ▼

- SD Test: Click to test your SD card. The system will display a message indicating success or failure. If you want to use your SD card for local storage, please format it before use. Please refer to page 108 for detailed information.

Add media

Click **Add media** to open the media setting window. You can specify the type of media that will be sent when a trigger is activated. A total of 5 media settings can be configured. There are three choices of media types available: Snapshot, Video Clip, and System log. Select the item to display the detailed configuration options. You can configure either one or all of them.

The screenshot shows a configuration window titled 'Add media'. At the top, there are two buttons: 'Add server' and 'Add media'. The 'Add media' button is highlighted. Below the buttons, the 'Media name' field contains the text 'Snapshot'. Under the 'Media type' section, three radio buttons are visible: 'Snapshot' (which is selected), 'Video clip', and 'System log'. Below the 'Snapshot' radio button, there are several input fields: 'Source' is a dropdown menu showing 'Stream 1'; 'Send' followed by a text box containing '1' and the label 'pre-event image(s) [0~7]'; another 'Send' followed by a text box containing '1' and the label 'post-event image(s) [0~7]'; and 'File name prefix' followed by a text box containing 'Snapshot_'. There is also a checkbox labeled 'Add date and time suffix to file name' which is currently unchecked. At the bottom of the window, there are two buttons: 'Close' and 'Save media'.

Media type - Snapshot

Select to send snapshots when a trigger is activated.

- Media name: Enter a name for the media setting.
- Source: Select to take snapshots from stream 1 ~ 4. (The following options are available when the check circle is selected.)
- Send pre-event images
The Network Camera has a buffer area; it temporarily holds data up to a certain limit. Enter a number to decide how many images to capture before a trigger is activated. Up to 7 images can be generated.
- Send post-event images
Enter a number to decide how many images to capture after a trigger is activated. Up to 7 images can be generated.

For example, if both the pre-event images and post-event images are set to be 7, a total of 15 images are generated when a trigger is activated.

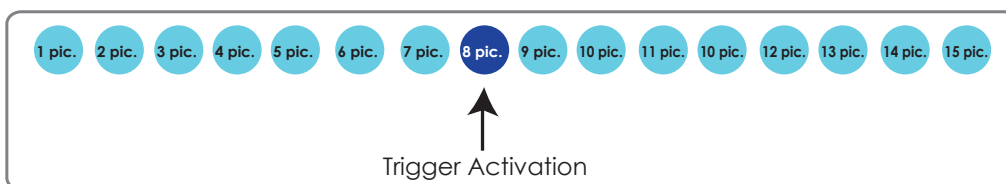

- File name prefix
Enter the text that will be appended to the front of the file name.

- Add date and time suffix to the file name
Select this option to add a date/time suffix to the file name.
For example:

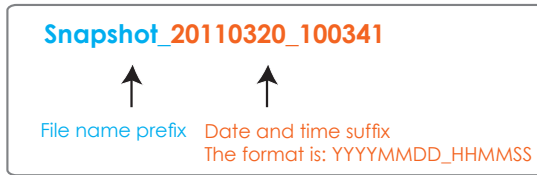

Click **Save media** to enable the settings, then click **Close** to exit the Add media page.

After you set up the first media server, a new column for media server will automatically show up on the Media list. If you wish to add more media options, click **Add media**.

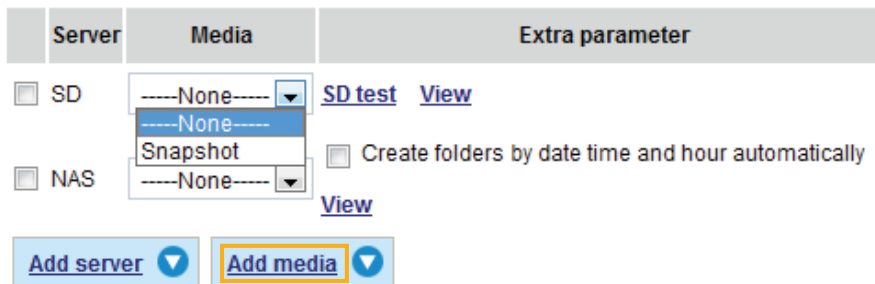

Media type - Video clip

Select to send video clips when a trigger is activated.

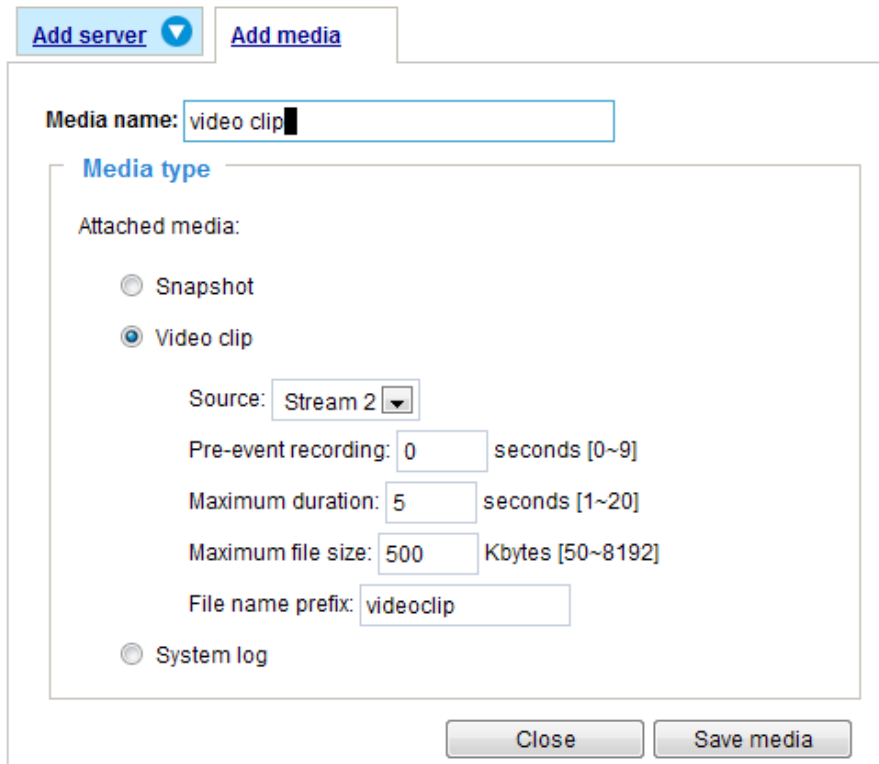

- Media name: Enter a name for the media setting.
- Source: Select the source of video clip.
- Pre-event recording
The Network Camera has a buffer area; it temporarily holds data up to a certain limit. Enter a number to decide the duration of recording before a trigger is activated. Up to 9 seconds can be set.

■ Maximum duration

Specify the maximum recording duration in seconds. Up to 20 seconds can be set. For example, if pre-event recording is set to 5 seconds and the maximum duration is set to 10 seconds, the Network Camera continues to record for another 4 seconds after a trigger is activated.

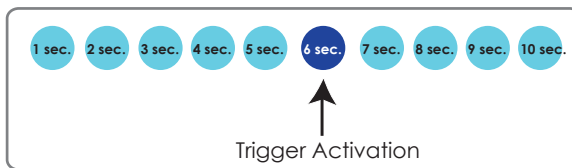

■ Maximum file size

Specify the maximum file size allowed.

■ File name prefix

Enter the text that will be appended to the front of the file name. For example:

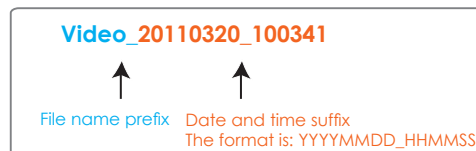

Click **Save media** to enable the settings, then click **Close** to exit the Add media page.

Media type - System log

Select to send a system log when a trigger is activated.

Click **Save media** to enable the settings, then click **Close** to exit the Add media page.

Server	Media	Extra parameter
<input type="checkbox"/> SD	----None----	SD test View
<input type="checkbox"/> Email	Snapshot Video clip System log	
<input type="checkbox"/> FTP	----None----	
<input type="checkbox"/> HTTP	----None----	
<input type="checkbox"/> NAS	----None----	<input type="checkbox"/> Create folders by date time and hour automatically View

- **View:** Click this button to open a file list window. This function is only for SD card and Network Storage. If you click **View** button of SD card, a Local storage page will pop up for you to manage recorded files on SD card. For more information about Local storage, please refer to page 108. If you click **View** button of Network storage, a file directory window will pop up for you to view recorded data on Network storage.
- **Create folders by date, time, and hour automatically:** If you check this item, the system will generate folders automatically by date.

The following is an example of a file destination with video clips:

The format is: YYYYMMDD
Click to open the directory

Click to delete selected items

Click to delete all recorded data

Click [20110320](#) to open the directory:

The format is: HH (24r)
Click to open the file list for that hour

	file name	size	date	time
<input type="checkbox"/>	Video Clip_58.mp4	2526004	2011/03/20	07:58:28
<input type="checkbox"/>	Video Clip_59.mp4	2563536	2011/03/20	07:59:28

Click to delete selected items

Click to delete all recorded data

Click to go back to the previous level of the directory

	file name	size	date	time
<input type="checkbox"/>	Video Clip_58.mp4	2526004	2011/03/20	07:58:28
<input type="checkbox"/>	Video Clip_59.mp4	2563536	2011/03/20	07:59:28

The format is: File name prefix + Minute (mm)
You can set up the file name prefix on Add media page.

Here is an example of the Event setting:

Event name:

Enable this event

Priority:

Detect next motion detection or digital input after second(s).

1. Schedule

↓

2. Trigger

↓

3. Action

Action

Trigger digital output for seconds

Backup media if the network is disconnected

Move to preset location:

Note: Please configure [Preset locations](#) first

Server	Media	Extra parameter
<input checked="" type="checkbox"/> SD	<input type="text" value="Snapshot"/>	SD test View
<input type="checkbox"/> NAS	<input type="text" value="----None----"/>	<input type="checkbox"/> Create folders by date time and hour automatically View

[Add server](#)

[Add media](#)

When completed the settings with steps 1 to 3 to arrange Schedule, Trigger, and Action of an event, click **Save event** to enable the settings and click **Close** to exit the page.

The following is an example of the Event setting page:

Event

Name	Status	Sun	Mon	Tue	Wed	Thu	Fri	Sat	Time	Trigger	
Event1	ON	V	V	V	V	V	V	V	00:00~24:00	boot	<input type="button" value="Delete"/>

[Help](#)

Server settings

Name	Type	Address/Location	
NAS	ns	\\172.16.4.39\nas	<input type="button" value="Delete"/>

Media

Available memory space: 13000KB

Name	Type	
Snapshot	snapshot	<input type="button" value="Delete"/>
Video clip	videoclip	<input type="button" value="Delete"/>
System log	systemlog	<input type="button" value="Delete"/>

When the Event Status is **ON**, once an event is triggered by motion detection, the Network Camera will automatically send snapshots via e-mail.

If you want to stop the event trigger, you can click **ON** to turn it to **OFF** status or click **Delete** to remove the event setting.

To remove a server setting from the list, select a server name and click **Delete**. Note that only when the server setting is not being applied to an event setting can it be deleted.

To remove a media setting from the list, select a media name and click **Delete**. Note that only when the media setting is not being applied to an event setting can it be deleted.

Customized Script

This function allows you to upload a sample script (.xml file) to the camera, which will save your time on configuring the settings. Please note that there is a limited number of customized scripts you can upload; if the current amount of customized scripts has reached the limit, an alert message will prompt. If you need more information, please contact VIVOTEK technical support.

Customized Script

Name	Date	Time
User1	20081113	18:13:46
User2	20081113	18:11:32

Click to upload a file

```

<?xml version="1.0" encoding="UTF-8"?>
<eventmgr version="0102">
<maxprocess>1</maxprocess>
<!-- From 08:30:00-20:30:00 on Monday to Friday every week -->
<schedule id="0">
<duration>
<weekday>1-5</weekday>
<time>08:30:00-20:30:00</time>
</duration>
</schedule>
<!-- Motion -->
<motion condition="0">
<status id="0">trigger</status>
<status id="1">trigger</status>
</motion>
<event id="0">
<description>Mail system log to email address</description>
<condition>c0</condition>
<scheduleno>0</scheduleno>
<delay>10</delay>
<!-- users can send email with title "Motion" to recipient pudding.yang@vivotek.com. The body
of mail is the log messages -->
<process>
/usr/bin/smtplib -s "Motion" -f IP7139@vivotek.com -b /var/log/messages -S ms.vivotek.tw -
M 3 pudding.yang@vivotek.com
</process>
<priority>0</priority>
</event>
</eventmgr>
                    
```

Click to modify the script online
→

Applications > Motion detection

This section explains how to configure the Network Camera to enable motion detection. A total of three motion detection windows can be configured.

Enable motion detection

(TCP-V)
2011/03/10 17:08:56

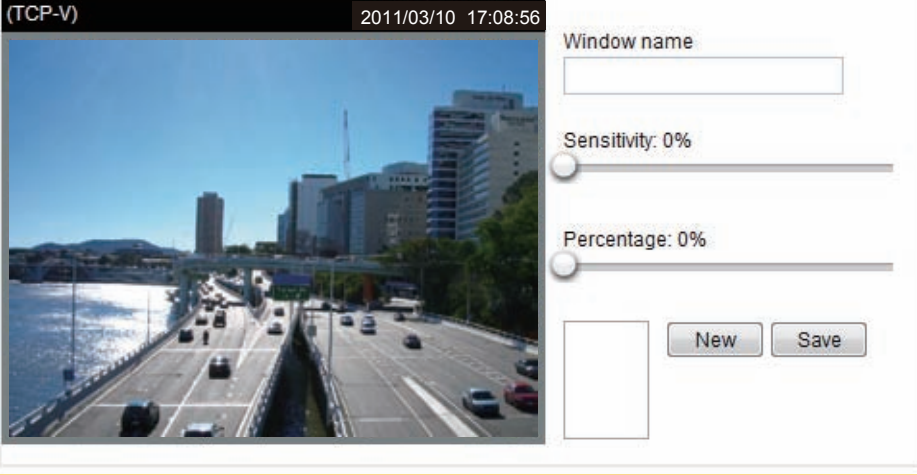

Motion Detection Setting 1:
For normal situations

Motion Detection Setting 2:
For special situations

Follow the steps below to enable motion detection:

1. Click **New** to add a new motion detection window.
2. In the Window Name text box, enter a name for the motion detection window.
 - To move and resize the window, drag and drop your mouse on the window.
 - To delete a window, click X on the upper right corner of the window.
3. Define the sensitivity to moving objects and the space ratio of all alerted pixels by moving the Sensitivity and Percentage slide bar.
4. Click **Save** to enable the settings.
5. Select **Enable motion detection** to enable this function.

For example: Enable motion detection

(TCP-V)
2011/3/11 14:30:30

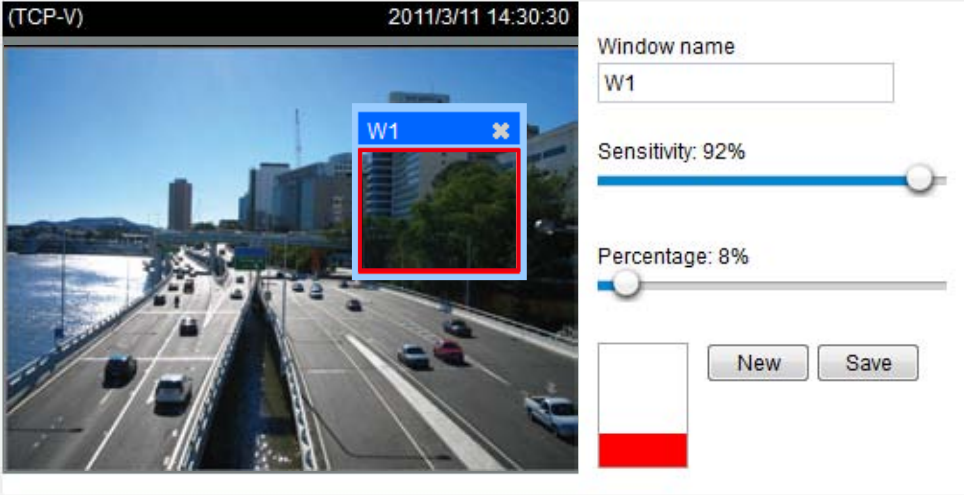

Profile

The Percentage Indicator will rise or fall depending on the variation between sequential images. When motions are detected by the Network Camera and are judged to exceed the defined threshold, the red bar rises. Meanwhile, the motion detection window will be outlined in red. Photos or videos can be captured instantly and configured to be sent to a remote server (Email, FTP) by utilizing this feature as a trigger source. For more information on how to set an event, please refer to Event settings on page 84.

A green bar indicates that even though motions have been detected, the event has not been triggered because the image variations still fall below the defined threshold.

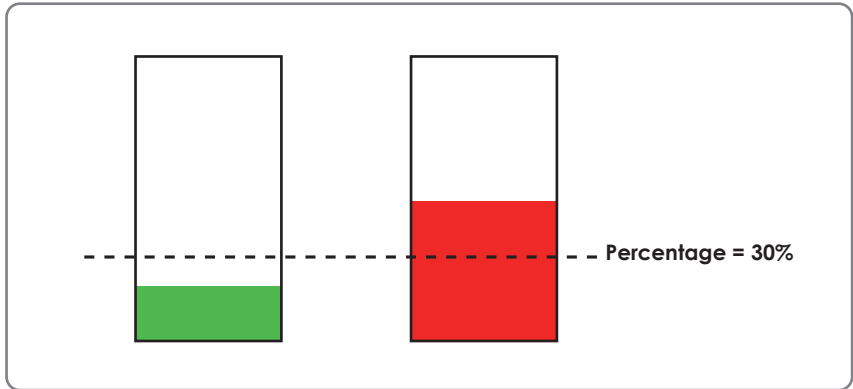

If you want to configure other motion detection settings for day/night/schedule mode, please click **Profile** to open the Motion Detection Profile Settings page as shown below. A total of three motion detection windows can be configured on this page as well.

(TCP-V) 2011/03/21 17:08:56



Window name

Sensitivity: 0%

Percentage: 0%

General settings

Enable this profile

This profile is applied to:

Day mode

Night mode

Schedule mode

Please follow the steps below to set up a profile:

1. Create a new motion detection window.
2. Check **Enable this profile**.
3. Select the applicable mode: Day mode, Night mode, or Schedule mode. Please manually enter a time range if you choose Schedule mode.
4. Click **Save** to enable the settings and click **Close** to exit the page.

This motion detection window will also be displayed on the Event settings page. You can go to Event > Event settings > Trigger to choose it as a trigger source. Please refer to page 85 for detailed information.

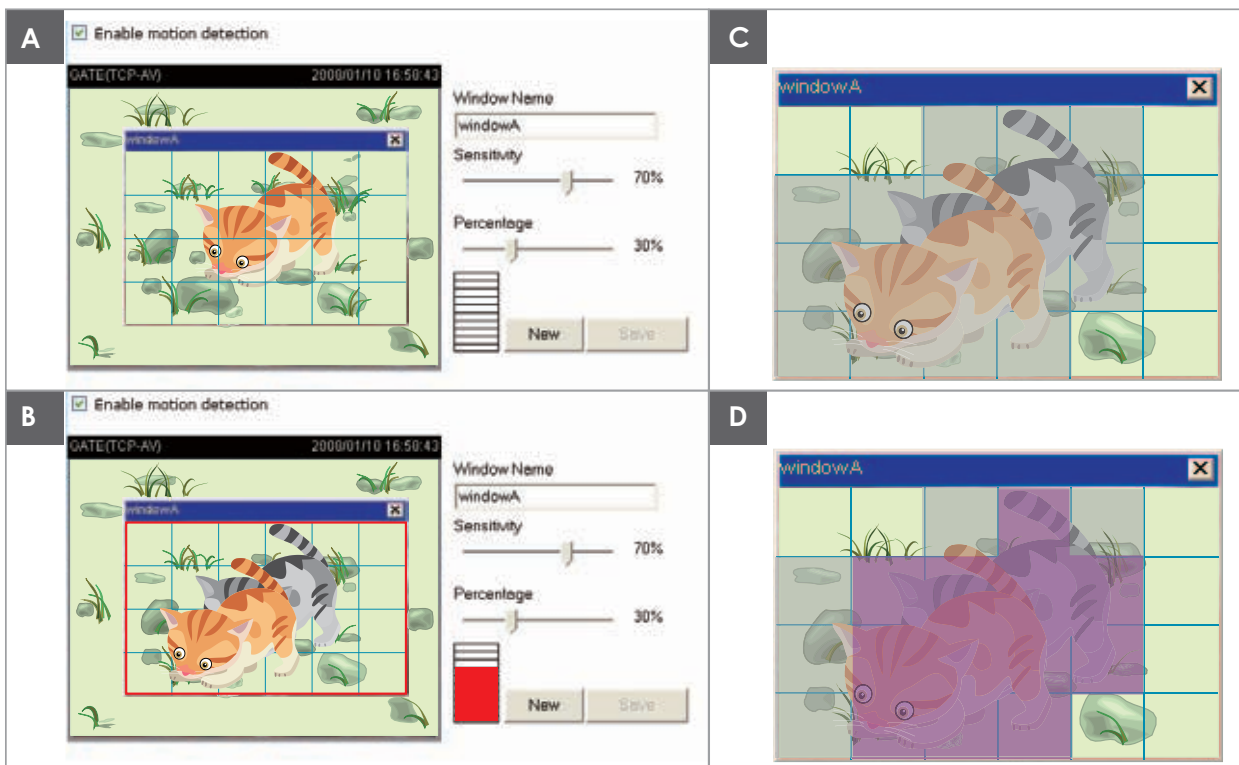
**NOTE:**► *How does motion detection work?*

There are two motion detection parameters: *Sensitivity* and *Percentage*. In the illustration above, frame A and frame B are two sequential images. Pixel differences between the two frames are detected and highlighted in gray (frame C) and will be compared with the sensitivity setting. *Sensitivity* is a value that expresses the sensitivity to moving objects. Higher sensitivity settings are expected to detect slight movements while smaller sensitivity settings will neglect them. When the sensitivity is set to 70%, the Network Camera defines the pixels in the purple areas as “alerted pixels” (frame D).

Percentage is a value that expresses the proportion of “alerted pixels” to all pixels in the motion detection window. In this case, 50% of pixels are identified as “alerted pixels”. When the percentage is set to 30%, the motions are judged to exceed the defined threshold; therefore, the motion window will be outlined in red.

For applications that require a high level of security management, it is suggested to use higher sensitivity settings and smaller percentage values.

Applications > DI and DO Advanced Mode

DI and DO

Digital input: The active state is

1: ; the current state detected is **High**

2: ; the current state detected is **High**

3: ; the current state detected is **High**

Digital output: The active state is

1: ; the current state detected is **Open**

2: ; the current state detected is **Open**

Digital input: Select High or Low to define normal status for the digital input. The Network Camera will report the current status.

Digital output: Select Grounded or Open to define normal status for the digital output. The Network Camera will show whether the trigger is activated or not.

Set up the event source as DI on **Event > Event settings > Trigger**. Please refer to page 85 for detailed information.

Applications > Audio detection Advanced Mode

Audio detection, along with video motion detection, is applicable in the following scenarios:

1. Detection of activities not covered by camera view, e.g., a loud input by gunshots or breaking a door or window.
2. A usually noisy environment, such as a factory, suddenly becomes quiet due to a breakdown of machines.
3. A PTZ camera can be directed to turn to a preset point by the occurrence of audio events.
4. Dark environments where video motion detection may not function well.

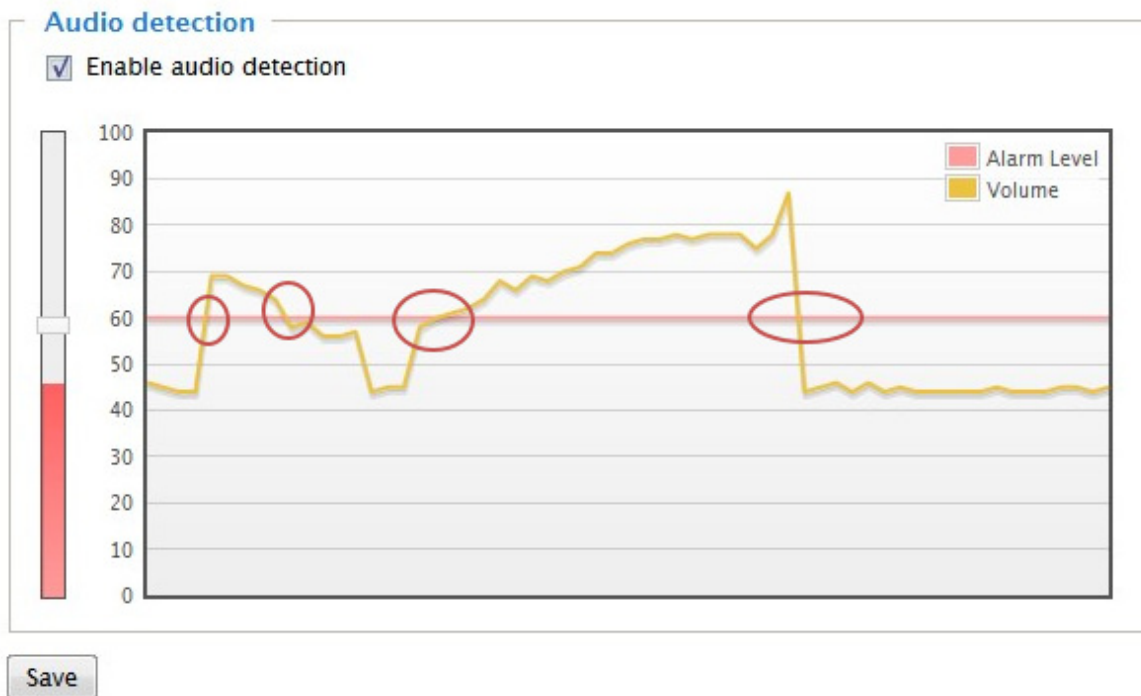

The red circles in the diagram above indicate where the audio alarms can be triggered when breaching or falling below the preset threshold.

How to configure Audio detection:

1. Once the Audio detection window is opened, the current sound input will be interactively indicated by a fluctuating yellow wave diagram.
2. Use a mouse click to drag the **Alarm level** tab to a preferred location on the slide bar.
3. Select the "**Enable audio detection**" checkbox and click **Save** to enable the feature.



NOTE:

1. Note that the numbers (0~100) on the side of wave diagram do not represent decibel (dB). A sound intensity level has already been mapped to preset values. You can, however, use the real-world inputs at your installation site as they are shown on the wave diagram to configure an alarm level.
2. To configure this feature, you must not mute the audio in Configuration -> Media -> Audio. The default of the camera can be muted due to the lack of an internal microphone. An external microphone is separately provided by users.
3. Refer to page 81 for Audio input adjustment such as Audio input gain. If audio settings have been tuned, you should reconfigure the audio alarm setting.

**IMPORTANT!**

- If the Alarm level and the received volume are set within a range of 20% on the wave diagram, frequent alarms will be triggered. It is therefore recommended to set the Alarm level farther apart from the detected sound level.
 - To configure and enable this feature, you **must not** configure **video stream #1** into **Motion JPEG**. If an external microphone input is connected and recording of audio stream is preferred, audio stream is transmitted between camera and viewer/recording station along with stream #1.
 - Refer to page 81 for Audio settings, and page 78 for video streaming settings.
-

Recording > Recording settings Advanced Mode

This section explains how to configure the recording settings for the Network Camera.

Recording Settings

Insert your SD card and click here to test

Recording settings

Name	Status	Sun	Mon	Tue	Wed	Thu	Fri	Sat	Time	Source	Destination	Delete
<div style="display: flex; align-items: center; gap: 10px;"> <input type="button" value="Add"/> SD test </div>												

NOTE:

► Please remember to format your SD card when using for the first time. Please refer to page 108 for detailed information.

Recording Settings

Click **Add** to open the recording setting window. On this page, you can define the adaptive recording, recording source, recording schedule, and recording capacity. A total of 2 recording settings can be configured.

Recording name:

Enable this recording

With adaptive recording

Pre-event recording: seconds [0~9]

Post-event recording: seconds [0~10]

Priority: Normal

Source: Stream 1

Trigger

Schedule

Sun Mon Tue Wed Thu Fri Sat

Time

Always

From to [hh:mm]

Network fail

Note: To enable recording notification please configure [Event](#) first

- Recording name: Enter a name for the recording setting.
- Enable this recording: Select this option to enable video recording.
- With adaptive recording: Select this option will activate the frame rate control according to alarm trigger. The frame control means that when there is alarm trigger, the frame rate will raise up to the value you've set on Stream setting page. Please refer to page 78 for more information.

If you enable adaptive recording and enable time-shift cache stream on Camera A, only when an event is triggered on Camera A will the server record the full frame rate streaming data; otherwise, it will only request the I frame data during normal monitoring, thus effectively save lots of bandwidths and storage.

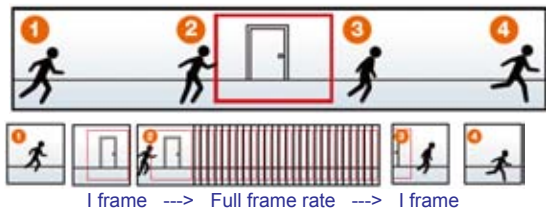

NOTE:

- ▶ To enable adaptive recording, please make sure you've set up the trigger source such as Motion Detection, DI Device, or Manual Trigger.
- ▶ When there is no alarm trigger:
 - JPEG mode: record 1 frame per second.
 - H.264 mode: record I frame only.
 - MPEG-4 mode: record I frame only.
- ▶ When the I frame period is >1s on Video settings page, it should be forced to make the I frame period to 1s when adaptive recording is activated.

The alarm trigger includes: motion detection and DI detection. Please refer to Event settings on page 84.

- Pre-event recording and post-event recording
The Network Camera has a buffer area; it temporarily holds data up to a certain limit. Enter a number to decide the duration of recording before and after a trigger is activated.
- Priority: Select the relative importance of this recording (High, Normal, or Low). Recording with a higher priority setting will be executed first.
- Source: Select a stream for the recording source.

NOTE:

- ▶ To enable adaptive recording, please also **enable time shift caching stream** and **select a caching stream** on Media > Video > Stream settings. Please refer to page 78 for detailed instruction.
- ▶ To enable recording notification please configure **Event settings** first. Please refer to page 84.

Please follow the steps 1~2 below to set up the recording:

1. Trigger

Select a trigger source.

Trigger

Schedule

Sun Mon Tue Wed Thu Fri Sat

Time

Always

From to [hh:mm]

Network fail

- Schedule: The server will start to record files on the local storage or network storage (NAS).
- Network fail: Since network fail, the server will start to record files on the local storage (SD card).

2. Destination

You can select the SD card or network storage (NAS) for the recorded video files.



Note: To enable recording notification please configure [Event](#) first



NAS server

Click **Add NAS server** to open the server setting window and follow the steps below to set up:

1. Fill in the information for your server.

For example:

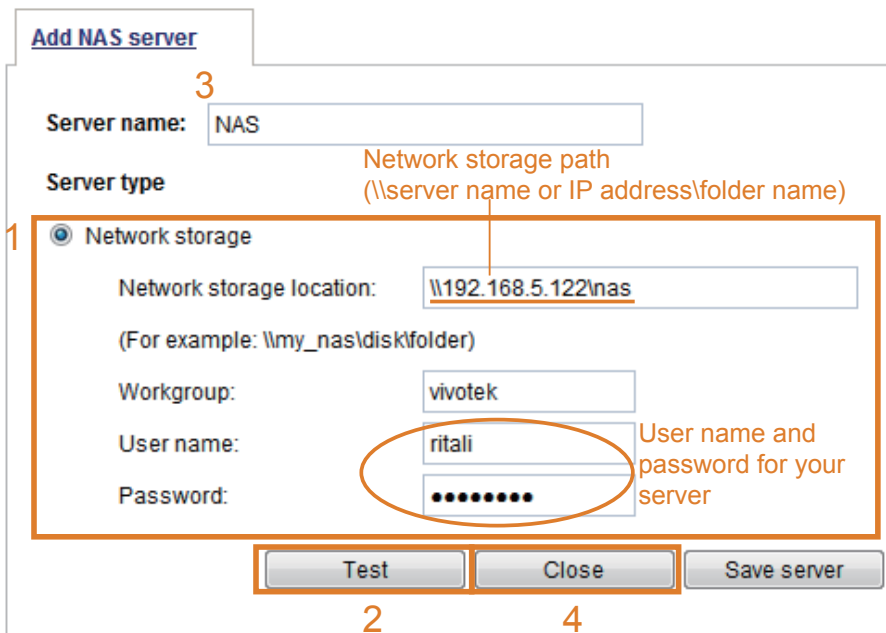

2. Click **Test** to check the setting. The result will be shown in the pop-up window.

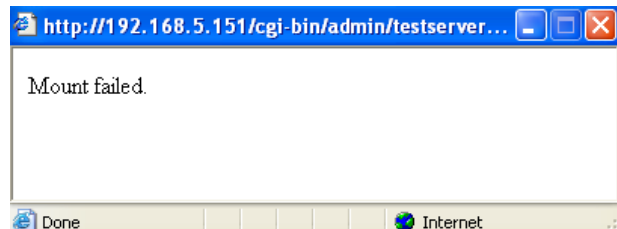
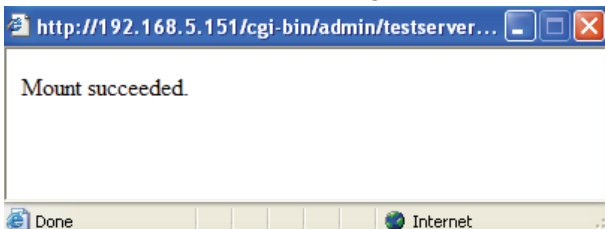

If successful, you will receive a test.txt file on the network storage server.

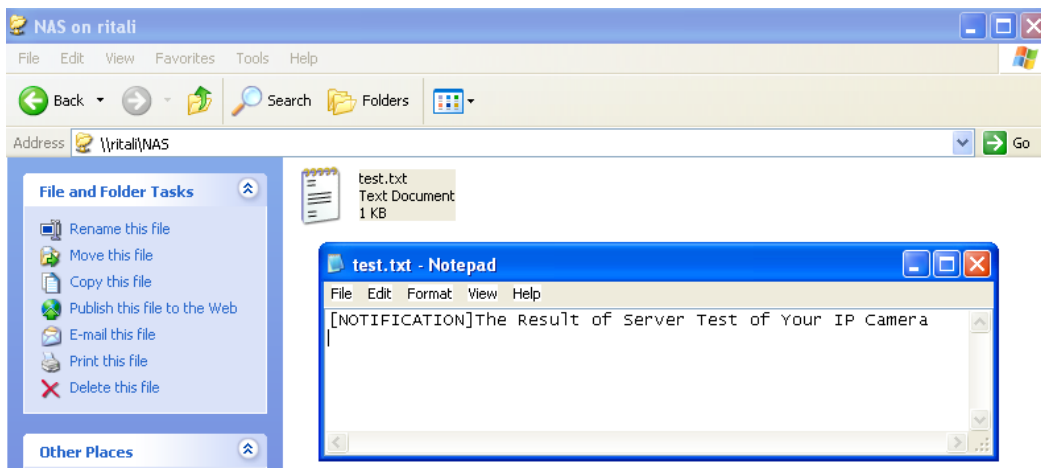

3. Enter a server name.
4. Click **Save** to complete the settings and click **Close** to exit the page.

Recording name:

Enable this recording

With adaptive recording

Pre-event recording: seconds [0~9]

Post-event recording: seconds [0~10]

Priority:

Source:

Destination

Destination:

Capacity:

Entire free space

Reserved space: Mbytes

File name prefix:

Enable cyclic recording

Note: To enable recording notification please configure [Event](#) first

- Capacity: You can choose either the entire free space available or limit the reserved space. The recording size limit must be larger than the reserved amount for cyclic recording. The reserved amount is reserved for cyclic recording to prevent malfunction during the transaction stage when the storage space is about to be full. This value must be larger than 15 MBytes.
- File name prefix: Enter the text that will be appended to the front of the file name.
- Enable cyclic recording: If you check this item, when the maximum capacity is reached, the oldest file will be overwritten by the latest one.

If you want to enable recording notification, please click [Event](#) to set up. Please refer to **Event > Event settings** on page 84 for more details.

When completed, select **Enable this recording**. Click **Save** to enable the setting and click **Close** to exit this page. When the system begins recording, it will send the recorded files to the network storage or SD

card. The new recording name will appear on the recording page as shown below.

To remove a recording setting from the list, select it and click **Delete**.

Recording settings

Name	Status	Sun	Mon	Tue	Wed	Thu	Fri	Sat	Time	Source	Destination	Delete
Video	ON	V	V	V	V	V	V	V	00:00~24:00	stream1	SD	Delete

[SD test](#)

- **[Video](#) (Name)**: Click to open the Recording settings page to modify.
- **[ON](#) (Status)**: Click to manually adjust the Status. ([ON](#): start recording; [OFF](#): stop recording)
- **[NAS](#) or [SD](#) (Destination)**: Click to open the file list of recordings as shown below. For more information about folder naming rules, please refer to page 97 or page 94 for details.

Local storage > SD card management

This section explains how to manage the local storage on the Network Camera. Here you can view SD card status, and implement SD card control.

SD card status

This column shows the status and reserved space of your SD card. Please remember to format the SD card when using for the first time.

SD card status

SD card status: **Detached** — **no SD card**

Total size:	0 KBytes	Free size:	0 KBytes
Used size:	0 KBytes	Use (%):	0 %

SD card status

SD card status: Ready

Total size:	7810152 KBytes	Free size:	7602048 KBytes
Used size:	208104 KBytes	Use (%):	2.665 %

SD card control

SD card control

Enable cyclic storage

Enable automatic disk cleanup

Maximum duration for keeping files: days

- **Enable cyclic storage:** Check this item if you want to enable cyclic recording. When the maximum capacity is reached, the oldest file will be overwritten by the latest one.
- **Enable automatic disk cleanup:** Check this item and enter the number of days you wish to retain a file. For example, if you enter “7 days”, the recorded files will be stored on the SD card for 7 days.

When all settings are completed, click **Save** to enable your settings.

Local storage > Content management

This section explains how to manage the content of recorded videos on the Network Camera. Here you can search and view the records and view the searched results.

Searching and Viewing the Records

This column allows the user to set up search criteria for recorded data. If you do not select any criteria and click **Search** button, all recorded data will be listed in the **Search Results** column.

Searching and viewing the records

File attributes

Trigger type: System boot Recording notify Motion
 Digital input Network fail Periodically
 Audio detection

Media type: Video clip Snapshot Text

Locked: Locked Unlocked

Backup: Backup

Trigger time

From: Date Time
 to: Date Time
(yyyy-mm-dd) (hh:mm:ss)

- File attributes: Select one or more items as your search criteria.
- Trigger time: Manually enter the time range you want to search.

Click **Search** and the recorded data corresponding to the search criteria will be listed in **Search Results** window.

Search Results

The following is an example of search results. There are four columns: Trigger time, Media type, Trigger type, and Locked. Click  to sort the search results in either direction.

Numbers of entries displayed on one page





Enter a key word to filter the search results

Highlight an item

Search results

Show 10 entries

Search:

	Trigger time 	Media Type 	Trigger type 	Locked 	Backup 
<input checked="" type="checkbox"/>	2010-08-26 10:42:55	Video Clip	Periodically	No	No
<input type="checkbox"/>	2010-08-26 10:43:56	Video Clip	Periodically	No	No
<input type="checkbox"/>	2010-08-26 10:44:56	Video Clip	Periodically	No	No
<input type="checkbox"/>	2010-08-26 10:45:57	Video Clip	Periodically	No	No
<input type="checkbox"/>	2010-08-26 10:46:58	Video Clip	Periodically	No	No
<input type="checkbox"/>	2010-08-26 ...	Video Clip	Periodically	No	No

- **View:** Click on a search result which will highlight the selected item in purple as shown above. Click the **View** button and a media window will pop up to play back the selected file. For example:



Click to adjust the image size

- **Download:** Click on a search result to highlight the selected item in purple as shown above. Then click the **Download** button and a file download window will pop up for you to save the file.
- **JPEGs to AVI:** This functions only applies to “JPEG” format files such as snapshots. You can select several snapshots from the list, then click this button. Those snapshots will be converted into an AVI file.
- **Lock/Unlock:** Select the desired search results, then click this button. The selected items will become Locked, which will not be deleted during cyclic recording. You can click again to unlock the selections. For example:

Search results

Show entries

Search:

	Trigger time	Media Type	Trigger type	Locked	Backup
<input checked="" type="checkbox"/>	2010-08-26 10:42:55	Video Clip	Periodically	Yes	No
<input checked="" type="checkbox"/>	2010-08-26 10:43:56	Video Clip	Periodically	Yes	No
<input checked="" type="checkbox"/>	2010-08-26 10:44:56	Video Clip	Periodically	Yes	No
<input type="checkbox"/>	2010-08-26 10:45:57	Video Clip	Periodically	No	No
<input type="checkbox"/>	2010-08-26 10:46:58	Video Clip	Periodically	No	No
<input type="checkbox"/>	2010-08-26 10:47:59	Video Clip	Periodically	No	No
<input type="checkbox"/>	2010-08-26 10:49:00	Video Clip	Periodically	No	No
<input type="checkbox"/>	2010-08-26 10:50:00	Video Clip	Periodically	No	No
<input type="checkbox"/>	2010-08-26 10:51:01	Video Clip	Periodically	No	No
<input type="checkbox"/>	2010-08-26 10:52:00	Video Clip	Periodically	No	No

Showing 1 to 10 of 12 entries



Click to switch pages

Note: "View" and "Download" only apply to the highlight item

- **Remove:** Select the desired search results, then click this button to delete the files.

Appendix

URL Commands for the Network Camera

1. Overview

For some customers who already have their own web site or web control application, the Network Camera/Video Server can be easily integrated through URL syntax. This section specifies the external HTTP-based application programming interface. The HTTP-based camera interface provides the functionality to request a single image, control camera functions (PTZ, output relay etc.), and get and set internal parameter values. The image and CGI-requests are handled by the built-in Web server.

2. Style Convention

In URL syntax and in descriptions of CGI parameters, text within angle brackets denotes content that is to be replaced with either a value or a string. When replacing the text string, the angle brackets should also be replaced. An example of this is the description of the name for the server, denoted with `<servername>` in the URL syntax description below, that is replaced with the string `myserver` in the URL syntax example further down in the page.

URL syntax is denoted with the word "Syntax:" written in bold face followed by a box with the referenced syntax as shown below. For example, name of the server is written as `<servername>` and is intended to be replaced with the name of the actual server. This can either be a name, e.g., "mywebcam" or "thecam.adomain.net" or the associated IP number for the server, e.g., 192.168.0.220.

Syntax:

```
http://<servername>/cgi-bin/viewer/video.jpg
```

Description of returned data is written with "Return:" in bold face followed by the returned data in a box. All data is returned in HTTP format, i.e., each line is separated with a Carriage Return and Line Feed (CRLF) printed as `\r\n`.

Return:

```
HTTP/1.0 <HTTP code> <HTTP text>\r\n
```

URL syntax examples are written with "Example:" in bold face followed by a short description and a light grey box with the example.

Example: request a single snapshot image

```
http://mywebserver/cgi-bin/viewer/video.jpg
```

3. General CGI URL Syntax and Parameters

CGI parameters are written in lower-case and as one word without any underscores or other separators. When the CGI request includes internal camera parameters, these parameters must be written exactly as they are named in the camera or video server. The CGIs are organized in functionally-related directories under the cgi-bin directory. The file extension .cgi is required.

Syntax:

```
http://<servername>/cgi-bin/<subdir>[/<subdir>...]/<cgi>.<ext>
[?<parameter>=<value>[&<parameter>=<value>...]]
```

Example: Set digital output #1 to active

```
http://mywebserver/cgi-bin/dido/setdo.cgi?dol=1
```

4. Security Level

SECURITY LEVEL	SUB-DIRECTORY	DESCRIPTION
0	anonymous	Unprotected.
1 [view]	anonymous, viewer, dido, camctrl	1. Can view, listen, talk to camera. 2. Can control DI/DO, PTZ of the camera.
4 [operator]	anonymous, viewer, dido, camctrl, operator	Operator access rights can modify most of the camera's parameters except some privileges and network options.
6 [admin]	anonymous, viewer, dido, camctrl, operator, admin	Administrator access rights can fully control the camera's operations.
7	N/A	Internal parameters. Unable to be changed by any external interfaces.

5. Get Server Parameter Values

Note: The access right depends on the URL directory.

Method: GET/POST

Syntax:

```
http://<servername>/cgi-bin/anonymous/getparam.cgi?[<parameter>]
[&<parameter>...]

http://<servername>/cgi-bin/viewer/getparam.cgi?[<parameter>]
```



```
[&<parameter>...]

http://<servername>/cgi-bin/operator/getparam.cgi?[<parameter>]

[&<parameter>...]

http://<servername>/cgi-bin/admin/getparam.cgi?[<parameter>]

[&<parameter>...]
```

Where the *<parameter>* should be *<group>[_<name>]* or *<group>[.<name>]*. If you do not specify any parameters, all the parameters on the server will be returned. If you specify only *<group>*, the parameters of the related group will be returned.

When querying parameter values, the current parameter values are returned.

A successful control request returns parameter pairs as follows:

Return:

```
HTTP/1.0 200 OK\r\n
Content-Type: text/html\r\n
Context-Length: <length>\r\n
\r\n
<parameter pair>
```

where *<parameter pair>* is

<parameter>=<value>\r\n

[*<parameter pair>*]

<length> is the actual length of content.

Example: Request IP address and its response

Request:

```
http://192.168.0.123/cgi-bin/admin/getparam.cgi?network_ipaddress
```

Response:

```
HTTP/1.0 200 OK\r\n
Content-Type: text/html\r\n
Context-Length: 33\r\n
\r\n
network.ipaddress=192.168.0.123\r\n
```

6. Set Server Parameter Values

Note: The access right depends on the URL directory.

Method: GET/POST

Syntax:

```
http://<servername>/cgi-bin/<anonymous>/setparam.cgi? <parameter>=<value>
[&<parameter>=<value>...][&update=<value>][&return=<return page>]

http://<servername>/cgi-bin/<viewer>/setparam.cgi? <parameter>=<value>
[&<parameter>=<value>...][&update=<value>] [&return=<return page>]

http://<servername>/cgi-bin/<operator>/setparam.cgi? <parameter>=<value>
[&<parameter>=<value>...][&update=<value>] [&return=<return page>]

http://<servername>/cgi-bin/<admin>/setparam.cgi? <parameter>=<value>
[&<parameter>=<value>...][&update=<value>] [&return=<return page>]
```

PARAMETER	VALUE	DESCRIPTION
<group>_<name>	value to assigned	Assign <value> to the parameter <group>_<name>.
update	<boolean>	Set to 1 to update all fields (no need to update parameter in each group).
return	<return page>	Redirect to the page <return page> after the parameter is assigned. The <return page> can be a full URL path or relative path according to the current path. If you omit this parameter, it will redirect to an empty page. (Note: The return page can be a general HTML file (.htm, .html) or a VIVOTEK server script executable (.vspx) file. It cannot be a CGI command or have any extra parameters. This parameter must be placed at the end of the parameter list

Return:

```
HTTP/1.0 200 OK\r\n
Content-Type: text/html\r\n
Content-Length: <length>\r\n
\r\n
<parameter pair>
```

where <parameter pair> is

<parameter>=<value>\r\n

[<parameter pair>]

Only the parameters that you set and are readable will be returned.

Example: Set the IP address of server to 192.168.0.123:

Request:

http://myserver/cgi-bin/admin/setparam.cgi?network_ipaddress=192.168.0.123

Response:

HTTP/1.0 200 OK\r\n

Content-Type: text/html\r\n

Context-Length: 33\r\n

\r\n

network.ipaddress=192.168.0.123\r\n

7. Available parameters on the server

Valid values:

VALID VALUES	DESCRIPTION
string[<n>]	Text strings shorter than `n` characters. The characters `; , < , > , &` are invalid.
string[n~m]	Text strings longer than `n` characters and shorter than `m` characters. The characters `; , < , > , &` are invalid.
password[<n>]	The same as string but displays `*` instead.
integer	Any number between $(-2^{31} - 1)$ and $(2^{31} - 1)$.
positive integer	Any number between 0 and $(2^{32} - 1)$.
<m> ~ <n>	Any number between `m` and `n`.
domain name[<n>]	A string limited to a domain name shorter than `n` characters (eg. www.ibm.com).
email address [<n>]	A string limited to an email address shorter than `n` characters (eg. joe@www.ibm.com).
ip address	A string limited to an IP address (eg. 192.168.1.1).
mac address	A string limited to contain a MAC address without hyphens or colons.
boolean	A boolean value of 1 or 0 represents [Yes or No], [True or False], [Enable or Disable].
<value1>, <value2>, <value3>, ...	Enumeration. Only given values are valid.
blank	A blank string.

everything inside <>	A description
integer primary key	SQLite data type. A 32-bit signed integer. The value is assigned a unique integer by the server.
text	SQLite data type. The value is a text string, stored using the database encoding (UTF-8, UTF-16BE or UTF-16-LE).
coordinate	x, y coordinate (eg. 0,0)
window size	window width and height (eg. 800x600)

NOTE: The camera should not be restarted when parameters are changed.

7.1 system

Group: **system**

NAME	VALUE	DEFAULT	SECURITY (get/set)	DESCRIPTION
hostname	string[40]	Mega-Pixel Network Camera	1/6	Host name of server (Network Camera, Wireless Network Camera, Video Server, Wireless Video Server).
ledoff	<boolean>	0	6/6	Turn on (0) or turn off (1) all led indicators.
lowlight	<boolean>	1	6/6	Turn on white light LED under all conditions. Only turn on white light LED in low light conditions. (product dependent)
date	<YYYY/MM/ DD>, keep, auto	<current date>	6/6	Current date of system. Set to 'keep' to keep date unchanged. Set to 'auto' to use NTP to synchronize date.
time	<hh:mm:s s>, keep, auto	<current time>	6/6	Current time of the system. Set to 'keep' to keep time unchanged. Set to 'auto' to use NTP to synchronize time.
datetime	<MMDDhh mmYYYY.ss >	<blank>	6/6	Another current time format of the system.

ntp	<domain name>, <ip address>, <blank>	<blank>	6/6	NTP server. *Do not use "skip to invoke default server" for default value.
timezoneindex	-489 ~ 529	320	6/6	Indicate timezone and area. -480: GMT-12:00 Eniwetok, Kwajalein -440: GMT-11:00 Midway Island, Samoa -400: GMT-10:00 Hawaii -360: GMT-09:00 Alaska -320: GMT-08:00 Las Vegas, San_Francisco, Vancouver -280: GMT-07:00 Mountain Time, Denver -281: GMT-07:00 Arizona -240: GMT-06:00 Central America, Central Time, Mexico City, Saskatchewan -200: GMT-05:00 Eastern Time, New York, Toronto -201: GMT-05:00 Bogota, Lima, Quito, Indiana -180: GMT-04:30 Caracas -160: GMT-04:00 Atlantic Time, Canada, La Paz, Santiago -140: GMT-03:30 Newfoundland -120: GMT-03:00 Brasilia, Buenos Aires, Georgetown, Greenland -80: GMT-02:00 Mid-Atlantic -40: GMT-01:00 Azores, Cape_Verde_IS. 0: GMT Casablanca, Greenwich Mean Time: Dublin,

				<p>Edinburgh, Lisbon, London</p> <p>40: GMT 01:00 Amsterdam, Berlin, Rome, Stockholm, Vienna, Madrid, Paris</p> <p>41: GMT 01:00 Warsaw, Budapest, Bern</p> <p>80: GMT 02:00 Athens, Helsinki, Istanbul, Riga</p> <p>81: GMT 02:00 Cairo</p> <p>82: GMT 02:00 Lebanon, Minsk</p> <p>83: GMT 02:00 Israel</p> <p>120: GMT 03:00 Baghdad, Kuwait, Riyadh, Moscow, St. Petersburg, Nairobi</p> <p>121: GMT 03:00 Iraq</p> <p>140: GMT 03:30 Tehran</p> <p>160: GMT 04:00 Abu Dhabi, Muscat, Baku, Tbilisi, Yerevan</p> <p>180: GMT 04:30 Kabul</p> <p>200: GMT 05:00 Ekaterinburg, Islamabad, Karachi, Tashkent</p> <p>220: GMT 05:30 Calcutta, Chennai, Mumbai, New Delhi</p> <p>230: GMT 05:45 Kathmandu</p> <p>240: GMT 06:00 Almaty, Novosibirsk, Astana, Dhaka, Sri Jayawardenepura</p> <p>260: GMT 06:30 Rangoon</p> <p>280: GMT 07:00 Bangkok, Hanoi, Jakarta, Krasnoyarsk</p> <p>320: GMT 08:00 Beijing, Chongqing, Hong Kong, Kuala Lumpur, Singapore, Taipei</p> <p>360: GMT 09:00 Osaka, Sapporo, Tokyo, Seoul, Yakutsk</p> <p>380: GMT 09:30 Adelaide,</p>
--	--	--	--	---

				<p>Darwin</p> <p>400: GMT 10:00 Brisbane, Canberra, Melbourne, Sydney, Guam, Vladivostok</p> <p>440: GMT 11:00 Magadan, Solomon Is., New Caledonia</p> <p>480: GMT 12:00 Aucklan, Wellington, Fiji, Kamchatka, Marshall Is.</p> <p>520: GMT 13:00 Nuku'Alofa</p>
daylight_enable	<boolean>	0	6/6	Enable automatic daylight saving time in time zone.
daylight_dstactualmode	<boolean>	1	6/7	Check if current time is under daylight saving time. (Used internally)
daylight_auto_begintime	string[19]	NONE	6/7	Display the current daylight saving start time.
daylight_auto_endtime	string[19]	NONE	6/7	Display the current daylight saving end time.
daylight_timezones	string	,-360,-320, -280,-240, -241,-200, -201,-160, -140,-120, -80,-40,0, 40,41,80, 81,82,83, 120,140, 380,400,48 0	6/6	List time zone index which support daylight saving time.
updateinterval	0, 3600, 86400, 604800, 2592000	0	6/6	0 to Disable automatic time adjustment, otherwise, it indicates the seconds between NTP automatic update intervals.
restore	0, <positive integer>	N/A	7/6	Restore the system parameters to default values after <value> seconds.
reset	0, <positive	N/A	7/6	Restart the server after <value> seconds if <value>

	integer>			is non-negative.
restoreexceptnet	<Any value>	N/A	7/6	Restore the system parameters to default values except (ipaddress, subnet, router, dns1, dns2, pppoe). This command can cooperate with other "restoreexceptXYZ" commands. When cooperating with others, the system parameters will be restored to the default value except for a union of the combined results.
restoreexceptdst	<Any value>	N/A	7/6	Restore the system parameters to default values except all daylight saving time settings. This command can cooperate with other "restoreexceptXYZ" commands. When cooperating with others, the system parameters will be restored to default values except for a union of combined results.
restoreexceptlang	<Any Value>	N/A	7/6	Restore the system parameters to default values except the custom language file the user has uploaded. This command can cooperate with other "restoreexceptXYZ" commands. When cooperating with others, the system parameters will be restored to the default value except for a union of the combined results.

7.1.1 system.info

Subgroup of **system: info** (The fields in this group are unchangeable.)

NAME	VALUE	DEFAULT	SECURITY (get/set)	DESCRIPTION
modelName	string[40]	SD83X1_X 2_X3	0/7	Internal model name of the server (eg. IP7139)
extendedmodelName	string[40]	SD83X1_X 2_X3	0/7	ODM specific model name of server (eg. DCS-5610). If it is not an ODM model, this field will be equal to "modelName"
serialnumber	<mac address>	<product mac address>	0/7	12 characters MAC address (without hyphens).
firmwareversion	string[40]	<product dependent >	0/7	Firmware version, including model, company, and version number in the format: <MODEL-BRAND-VERSION>
language_count	<integer>	9	0/7	Number of webpage languages available on the server.
language_i<0~(count-1)>	string[16]	<product dependent >	0/7	Available language lists.
customlanguage_maxcount	<integer>	1	0/6	Maximum number of custom languages supported on the server.
customlanguage_count	<integer>	0	0/6	Number of custom languages which have been uploaded to the server.
customlanguage_i<0~(maxcount-1)>	string	<blank>	0/6	Custom language name.

7.2 status

Group: **status**

NAME	VALUE	DEFAULT	SECURITY (get/set)	DESCRIPTION
videoactualmodulation <product dependent>	ntsc, pal	1	4/7	The actual modulation type (videoin.type=0).
di_i<0~(ndi-1)> <product dependent>	<boolean>	0	1/7	0 => Inactive, normal 1 => Active, triggered (capability.ndi > 0)
do_i<0~(ndo-1)> <product dependent>	<boolean>	0	1/7	0 => Inactive, normal 1 => Active, triggered (capability.ndo > 0)
daynight <product dependent>	day, night	<product dependent>	7/7	Current status of day, night.
onlinenum_rtsp	integer	0	6/7	Current number of RTSP connections.
onlinenum_httppush	integer	0	6/7	Current number of HTTP push server connections.
eth_i0	<string>	<product dependent>	1/7	Get network information from mii-tool.
vi_i<0~(nvi-1)> <product dependent>	<boolean>	0	1/7	Virtual input 0 => Inactive 1 => Active (capability.nvi > 0)

7.3 digital input behavior define

Group: **di_i<0~(ndi-1)>** (capability.ndi > 0)

NAME	VALUE	DEFAULT	SECURITY (get/set)	DESCRIPTION
normalstate	high, low	high	1/1	Indicates open circuit or closed circuit (inactive status)

7.4 digital output behavior define

Group: **do_i<0~(ndo-1)>** (*capability.ndo > 0*)

NAME	VALUE	DEFAULT	SECURITY (get/set)	DESCRIPTION
normalstate	open, grounded	open	1/1	Indicate open circuit or closed circuit (inactive status)

7.5 security

Group: security

NAME	VALUE	DEFAULT	SECURITY (get/set)	DESCRIPTION
privilege_do <product dependent>	view, operator, admin	operator	6/6	Indicate which privileges and above can control digital output (<i>capability.ndo > 0</i>)
privilege_camctrl <product dependent>	view, operator, admin	view	6/6	Indicate which privileges and above can control PTZ (<i>capability.ptzenabled > 0</i> or <i>capability.eptz > 0</i>)
user_i0_name	string[64]	root	6/7	User name of root
user_i<1~20>_name	string[64]	<blank>	6/7	User name
user_i0_pass	password[64]	<blank>	6/6	Root password
user_i<1~20>_pass	password[64]	<blank>	7/6	User password
user_i0_privilege	viewer, operator, admin	admin	6/7	Root privilege
user_i<1~20>_privilege	viewer, operator, admin	<blank>	6/6	User privilege

7.6 network

Group: **network**

NAME	VALUE	DEFAULT	SECURITY (get/set)	DESCRIPTION
preprocesses	<positive integer>	<blank>	7/6	<p>An 32-bit integer, each bit can be set separately as follows:</p> <p>Bit 0 => HTTP service; Bit 1=> HTTPS service; Bit 2=> FTP service; Bit 3 => Two way audio and RTSP Streaming service;</p> <p>To stop service before changing its port settings. It's recommended to set this parameter when change a service port to the port occupied by another service currently. Otherwise, the service may fail.</p> <p>Stopped service will auto-start after changing port settings.</p> <p>Ex: Change HTTP port from 80 to 5556, and change RTP port for video from 5556 to 20480. Then, set preprocess=9 to stop both service first. "/cgi-bin/admin/setparam.cgi? network_preprocess=9&network_http_port=5556& network_rtp_videoport=20480"</p>
type	lan, pppoe <product dependent>	lan	6/6	Network connection type.
resetip	<boolean>	1	6/6	<p>1 => Get ipaddress, subnet, router, dns1, dns2 from DHCP server at next reboot.</p> <p>0 => Use preset ipaddress, subnet, router, dns1, and dns2.</p>
ipaddress	<ip address>	<product dependent>	6/6	IP address of server.
subnet	<ip address>	<blank>	6/6	Subnet mask.

router	<ip address>	<blank>	6/6	Default gateway.
dns1	<ip address>	<blank>	6/6	Primary DNS server.
dns2	<ip address>	<blank>	6/6	Secondary DNS server.
wins1	<ip address>	<blank>	6/6	Primary WINS server.
wins2	<ip address>	<blank>	6/6	Secondary WINS server.

7.6.1 802.1x

Subgroup of **network: ieee8021x** (capability.protocol.ieee8021x > 0)

NAME	VALUE	DEFAULT	SECURITY (get/set)	DESCRIPTION
enable	<boolean>	0	6/6	Enable/disable IEEE 802.1x
eapmethod	eap-peap, eap-tls	eap-peap	6/6	Selected EAP method
identity_peap	String[64]	<blank>	6/6	PEAP identity
identity_tls	String[64]	<blank>	6/6	TLS identity
password	String[254]	<blank>	6/6	Password for TLS
privatekeypassword	String[254]	<blank>	6/6	Password for PEAP
ca_exist	<boolean>	0	6/6	CA installed flag
ca_time	<integer>	0	6/7	CA installed time. Represented in EPOCH
ca_size	<integer>	0	6/7	CA file size (in bytes)
certificate_exist	<boolean>	0	6/6	Certificate installed flag (for TLS)
certificate_time	<integer>	0	6/7	Certificate installed time. Represented in EPOCH
certificate_size	<integer>	0	6/7	Certificate file size (in bytes)
privatekey_exist	<boolean>	0	6/6	Private key installed flag (for TLS)
privatekey_time	<integer>	0	6/7	Private key installed time. Represented in EPOCH
privatekey_size	<integer>	0	6/7	Private key file size (in bytes)

7.6.2 QOS

Subgroup of **network: qos_cos** (capability.protocol.qos.cos > 0)

NAME	VALUE	DEFAULT	SECURITY (get/set)	DESCRIPTION
enable	<boolean>	0	6/6	Enable/disable CoS (IEEE 802.1p)
vlanid	1~4095	1	6/6	VLAN ID
video	0~7	0	6/6	Video channel for CoS
audio <product dependent>	0~7	0	6/6	Audio channel for CoS (capability.naudio > 0)
eventalarm	0~7	0	6/6	Event/alarm channel for CoS
management	0~7	0	6/6	Management channel for CoS
eventtunnel	0~7	0	6/6	Event/Control channel for CoS

Subgroup of **network: qos_dscp** (capability.protocol.qos.dscp > 0)

NAME	VALUE	DEFAULT	SECURITY (get/set)	DESCRIPTION
enable	<boolean>	0	6/6	Enable/disable DSCP
video	0~63	0	6/6	Video channel for DSCP
audio	0~63	0	6/6	Audio channel for DSCP (capability.naudio > 0)
eventalarm	0~63	0	6/6	Event/alarm channel for DSCP
management	0~63	0	6/6	Management channel for DSCP
eventtunnel	0~63	0	6/6	Event/Control channel for DSCP

7.6.3 IPV6

Subgroup of **network: ipv6** (capability.protocol.ipv6 > 0)

NAME	VALUE	DEFAULT	SECURITY (get/set)	DESCRIPTION
enable	<boolean>	0	6/6	Enable IPv6.
addonipaddress	<ip address>	<blank>	6/6	IPv6 IP address.
addonprefixlen	0~128	64	6/6	IPv6 prefix length.
addonrouter	<ip address>	<blank>	6/6	IPv6 router address.
addondns	<ip address>	<blank>	6/6	IPv6 DNS address.
allowoptional	<boolean>	0	6/6	Allow manually setup of IP address setting.

7.6.4 FTP

Subgroup of **network**: **ftp**

NAME	VALUE	DEFAULT	SECURITY (get/set)	DESCRIPTION
port	21, 1025~65535	21	6/6	Local ftp server port.

7.6.5 HTTP

Subgroup of **network**: **http**

NAME	VALUE	DEFAULT	SECURITY (get/set)	DESCRIPTION
port	80, 1025 ~ 65535	80	1/6	HTTP port.
alternateport	1025~65535	8080	6/6	Alternate HTTP port.
authmode	basic, digest	basic	1/6	HTTP authentication mode.
s0_accessname	string[32]	video.mjpg	1/6	HTTP server push access name for stream 1. (capability.protocol.spush_mjpeg =1 and capability.nmediastream > 0)
s1_accessname <product dependent>	string[32]	video2.mjpg	1/6	HTTP server push access name for stream 2. (capability.protocol.spush_mjpeg =1 and capability.nmediastream > 1)
s2_accessname <product dependent>	string[32]	video3.mjpg	1/6	Http server push access name for stream 3 (capability.protocol.spush_mjpeg =1 and capability.nmediastream > 2)
s3_accessname <product dependent>	string[32]	video4.mjpg	1/6	Http server push access name for stream 4 (capability.protocol.spush_mjpeg =1 and capability.nmediastream > 3)
s4_accessname <product	string[32]	videoany.mjpg	1/6	Http server push access name for stream 5

dependent>				(capability.protocol.spush_mjpeg = 1 and capability.nmediastream > 4) For some models, it is used for anystream. (capability.protocol.spush.mjpeg = 1 and capability.nanystream = 1)
anonymousviewing	<boolean>	0	1/6	Enable anonymous streaming viewing.

7.6.6 HTTPS port

Subgroup of **network**: **https_port** (capability.protocol.https > 0)

NAME	VALUE	DEFAULT	SECURITY (get/set)	DESCRIPTION
port	443, 1025 ~ 65535	443	1/6	HTTPS port.

7.6.7 RTSP

Subgroup of **network**: **rtsp** (capability.protocol.rtsp > 0)

NAME	VALUE	DEFAULT	SECURITY (get/set)	DESCRIPTION
port	554, 1025 ~ 65535	554	1/6	RTSP port. (capability.protocol.rtsp=1)
anonymousviewing	<boolean>	0	1/6	Enable anonymous streaming viewing.
authmode	disable, basic, digest	disable	1/6	RTSP authentication mode. (capability.protocol.rtsp=1)
s0_accessname	<boolean>	live.sdp	1/6	RTSP access name for stream1. (capability.protocol.rtsp=1 and capability.nmediastream > 0)
s1_accessname	<boolean>	live2.sdp	1/6	RTSP access name for stream2. (capability.protocol.rtsp=1 and capability.nmediastream > 0)

				> 1)
s2_accessname	<boolean>	live3.sdp	1/6	RTSP access name for stream3 (capability.protocol.rtsp=1 and capability.nmediastream > 2)
s3_accessname	<boolean>	live4.sdp	1/6	RTSP access name for stream4 (capability.protocol.rtsp=1 and capability.nmediastream > 3)
S4_accessname	<boolean>	liveany.sdp	1/6	RTSP access name for stream5 (capability.protocol.rtsp=1 and capability.nmediastream > 4) For some models, it is used for anystream. (capability.protocol.rtsp=1 and capability.nanystream = 1)
s0_audiotrack	<boolean>	0	1/6	Enable audio for stream1.
s1_audiotrack	<boolean>	0	1/6	Enable audio for stream2.
s2_audiotrack	<boolean>	0	1/6	Enable audio for stream3.
s3_audiotrack	<boolean>	0	1/6	Enable audio for stream4.
S4_audiotrack	<boolean>	0	1/6	Enable audio for stream5.

7.6.7.1 RTSP multicast

Subgroup of **network_rtsp_s<0~(n-1)>**: **multicast**, n is stream count (**capability.protocol.rtp.multicast > 0**)

NAME	VALUE	DEFAULT	SECURITY (get/set)	DESCRIPTION
alwaysmulticast	<boolean>	0	4/4	Enable always multicast.
ipaddress	<ip address>	For n=0, 239.128.1.99 For n=1, 239.128.1.100,	4/4	Multicast IP address.

		and so on.		
videoport	1025 ~ 65535	5560+n*2	4/4	Multicast video port.
audioport <product dependent>	1025 ~ 65535	5562+n*2	4/4	Multicast audio port. (capability.naudio > 0)
ttl	1 ~ 255	15	4/4	Multicast time to live value.

7.6.8 SIP port

Subgroup of **network: sip** (capability.protocol.sip > 0)

NAME	VALUE	DEFAULT	SECURITY (get/set)	DESCRIPTION
port	1025 ~ 65535	5060	1/6	SIP port.

7.6.9 RTP port

Subgroup of **network: rtp**

NAME	VALUE	DEFAULT	SECURITY (get/set)	DESCRIPTION
videoport	1025 ~ 65535	5556	6/6	Video channel port for RTP. (capability.protocol.rtp_unicast=1)
audioport	1025 ~ 65535	5558	6/6	Audio channel port for RTP. (capability.protocol.rtp_unicast=1)

7.6.10 PPPoE

Subgroup of **network: pppoe** (capability.protocol.pppoe > 0)

NAME	VALUE	DEFAULT	SECURITY (get/set)	DESCRIPTION
user	string[128]	<blank>	6/6	PPPoE account user name.
pass	password[64]	<blank>	6/6	PPPoE account password.

7.7 IP Filter

Group: ipfilter

NAME	VALUE	DEFAULT	SECURITY (get/set)	DESCRIPTION
enable	<boolean>	0	6/6	Enable access list filtering.
admin_enable	<boolean>	0	6/6	Enable administrator IP address.
admin_ip	String[44]	<blank>	6/6	Administrator IP address.
maxconnection	1~10	10	6/6	Maximum number of concurrent streaming connection(s).
type	0, 1	1	6/6	Ipfilter policy : 0 => allow 1 => deny
ipv4list_i<0~9>	Single address: <ip address> Network address: <ip address / network mask> Range address: <start ip address - end ip address>	<blank>	6/6	IPv4 address list.
ipv6list_i<0~9>	String[44]	<blank>	6/6	IPv6 address list.

7.8 Video input

Group: **videoin**

NAME	VALUE	DEFAULT	SECURITY (get/set)	DESCRIPTION
color	0, 1	1	4/4	0 => monochrome 1 => color
flip	<boolean>	0	4/4	Flip the image.
mirror	<boolean>	0	4/4	Mirror the image.
ptzstatus	<integer>	2	1/7	A 32-bit integer, each bit can be set separately as follows: Bit 0 => Support camera control

				function; 0(not support), 1(support) Bit 1 => Built-in or external camera; 0 (external), 1(built-in) Bit 2 => Support pan operation; 0(not support), 1(support) Bit 3 => Support tilt operation; 0(not support), 1(support) Bit 4 => Support zoom operation; 0(not support), 1(support) Bit 5 => Support focus operation; 0(not support), 1(support)
text	string[16]	<blank>	1/4	Enclose caption.
imprnttimestamp	<boolean>	0	4/4	Overlay time stamp on video.

7.8.1 Video input setting per channel

Group: **videoin_c<0~(n-1)>** for n channel products, and m is stream number

NAME	VALUE	DEFAULT	SECURITY (get/set)	DESCRIPTION
cmosfreq	50, 60	60	4/4	CMOS frequency. (capability.videoin.type=2)
whitebalance	auto, manual	auto	4/4	"auto" indicates auto white balance. "manual" indicates keep current value.
rgain	0~100	30	4/4	Manual set rgain value of gain control setting.
bgain	0~100	30	4/4	Manual set bgain value of gain control setting.
color	0, 1	1	4/4	0 => monochrome 1 => color
flip	<boolean>	0	4/4	Flip the image.
mirror	<boolean>	0	4/4	Mirror the image.
ptzstatus	<integer>	2	1/7	A 32-bit integer, each bit can be set separately as follows: Bit 0 => Support camera

				control function; 0(not support), 1(support) Bit 1 => Built-in or external camera; 0 (external), 1(built-in) Bit 2 => Support pan operation; 0(not support), 1(support) Bit 3 => Support tilt operation; 0(not support), 1(support) Bit 4 => Support zoom operation; 0(not support), 1(support) Bit 5 => Support focus operation; 0(not support), 1(support)
text	string[16]	<blank>	1/4	Enclose caption.
imprnttimestamp	<boolean>	0	4/4	Overlay time stamp on video.
options	quality, framerate	quality	4/4	Video input option: (1) Full HD (MAX1080P 30fps) (2) Exceptional frame rate (720P 60fps)
enablepreview	<boolean>	0	1/4	Usage for UI of exposure settings. Preview settings of video profile.
s<0~(m-1)>_codectype	mpeg4, mjpeg, h264 <product dependent>	H264	1/4	Video codec type.
s<0~(m-1)>_resolution	Reference capability_video resolution	QCIF, CIF, 4CIF, D1	1/4	Video resolution in pixels.
s<0~(m-1)>_mpeg4_intrap period	250, 500, 1000, 2000, 3000, 4000	1000	4/4	Intra frame period in milliseconds.
s<0~(m-1)>_mpeg4_rateco	cbr, vbr	vbr	4/4	cbr, constant bitrate

ntrolmode				vbr, fix quality
s<0~(m-1)>_mpeg4_quant	1~5 99, 100	3	4/4	Quality of video when choosing vbr in "ratecontrolmode". 99 is the customized manual input setting. 1 = worst quality, 5 = best quality. 100 is percentage mode.
s<0~(m-1)>_mpeg4_qvalue	2~31	7	4/4	Manual video quality level input. (s<0~(m-1)>_mpeg4_quant = 99)
s<0~(m-1)>_mpeg4_qpercent	1~100	29	4/4	Manual video quality level input. (s<0~(m-1)>_mpeg4_quant = 100)
s<0~(m-1)>_mpeg4_bitrate	1000~800000 0 <product dependent>	51200	4/4	Set bit rate in bps when choosing cbr in "ratecontrolmode".
s<0~(m-1)>_mpeg4_maxframe	1~25, 26~30 (only for NTSC or 60Hz CMOS)	30	1/4	Set maximum frame rate in fps (for MPEG-4).
s<0~(m-1)>_h264_intraperiod	250, 500, 1000, 2000, 3000, 4000	1000	4/4	Intra frame period in milliseconds.
s<0~(m-1)>_h264_ratecontrolmode	cbr, vbr	vbr	4/4	cbr, constant bitrate vbr, fix quality
s<0~(m-1)>_h264_quant	1~5 99, 100	3	4/4	Quality of video when choosing vbr in "ratecontrolmode". 99 is the customized manual input setting. 1 = worst quality, 5 = best quality. 100 is percentage mode.
s<0~(m-1)>_h264_qvalue	0~51	2	4/4	Manual video quality level input.

				(s<0~(m-1)>_h264_quant = 99)
s<0~(m-1)>_h264_qppercent	1~100	44	4/4	Manual video quality level input. (s<0~(m-1)>_h264_quant = 100)
s<0~(m-1)>_h264_bitrate	1000~8000000	30000000	4/4	Set bit rate in bps when choosing cbr in "ratecontrolmode".
s<0~(m-1)>_h264_maxframe	1~25, 26~30 (only for NTSC or 60Hz CMOS)	30	1/4	Set maximum frame rate in fps (for h264).
s<0~(m-1)>_h264_profile <product dependent>	0~2	1	1/4	Indicate H264 profiles 0: baseline 1: main profile 2: high profile
s<0~(m-1)>_mjpeg_quant	1~5 99, 100	3	4/4	Quality of JPEG video. 99 is the customized manual input setting. 1 = worst quality, 5 = best quality. 100 is percentage mode.
s<0~(m-1)>_mjpeg_qvalue	2~97	50	4/4	Manual video quality level input. (s<0~(m-1)>_mjpeg_quant = 99)
s<0~(m-1)>_mjpeg_qppercent	1~100	49	4/4	Manual video quality level input. (s<0~(m-1)>_mjpeg_quant = 100)
s<0~(m-1)>_mjpeg_maxframe	1~25, 26~30 (only for NTSC or 60Hz CMOS)	30	1/4	Set maximum frame rate in fps (for JPEG).
daynight	auto,schedule, day,night	auto	4/4	auto => auto daynight night => ircut filter on day => ircut filter off schedule => scheduled ircut filter

exposurecontrol	0~3	0	4/4	Select exposure mode. 0 => Auto with IRCut 1 => Shutter priority 2 => Iris priority 3 => Manual mode
exposurelevel	0~12	6	4/4	Exposure level
agc	1~12 (6db~28db)	5	4/4	Set auto gain control to normal level or MAX level.
enableblc	0~1	0	4/4	Enable backlight compensation (exposurecontrol => auto with IRCut)
shutterpriority	0~14	5	4/4	Exposure time (exposurecontrol(=> shutter priority)
irispriority	1~17 (F1.6 ~ F28)	13	4/4	Iris adjustment (exposurecontrol => Iris priority)
irismanual	1~17 (F1.6 ~ F28)	13	4/4	Iris adjustment (exposurecontrol => manual)
shutterspeed	0~14 (1/1 ~ 1/10000)	5	4/4	Exposure time (exposurecontrol => manual)
gain	0~15 (0db ~ 28db)	5	4/4	Gain control (exposurecontrol => manual)
wdr_mode	0~2	0	4/4	WDR enhanced. 0: off 1: manual 2: auto
wdr_shadowcorrection	0~2	1	4/4	WDR strength 0: low 1: medium 2: high
wdr_shortexposure	900,1800,2700 ,3600,4500,5400,6300,7200,8100,9000	1	4/4	Short exposure time : "900" : 1/900 "1800" : 1/1800 "2700" : 1/2700 "3600" : 1/3600

				"4500" : 1/4500 "5400" : 1/5400 "6300" : 1/6300 "7200" : 1/7200 "8100" : 1/8100 "9000" : 1/9000 (wdr_mode : 1)
wdr_sensitivity	0~2	1	4/4	WDR strength 0: low 1: medium 2: high (wdr_mode: 2)

7.8.1.1 Alternative video input profiles per channel

In addition to the primary setting of video input, there can be alternative profile video input setting for each channel which might be for different scene of light (daytime or nighttime).

Group: **videoin_c0_profile_i<0~(m-1)>** (*capability. nvideoinprofile > 0*)

NAME	VALUE	DEFAULT	SECURITY (get/set)	DESCRIPTION
enable	<boolean>	0	4/4	Enable/disable this profile setting
policy	day, night, schedule	night	4/4	The mode which the profile is applied to.
beginntime	hh:mm	18:00	4/4	Begin time of schedule mode.
endtime	hh:mm	06:00	4/4	End time of schedule mode.
exposurecontrol	0~3	0	4/4	Select exposure mode. 0 => Auto with IRCut 1 => Shutter priority 2 => Iris priority 3 => Manual mode
exposurelevel	0~12	6	4/4	Exposure level
agc	1~12 (6db~28db)	5	4/4	Set auto gain control to normal level or MAX level.
enableblc	0~1	0	4/4	Enable backlight compensation (exposurecontrol => auto with IRCut)
shutterpriority	0~14	5	4/4	Exposure time (exposurecontrol(=> shutter

				priority)
irispriority	1~13 (F1.6 ~ F14)	13	4/4	Iris adjustment (exposurecontrol => Iris priority)
irismanual	1~13 (F1.6 ~ F14)	13	4/4	Iris adjustment (exposurecontrol => manual)
shutterspeed	0~14 (1/1 ~ 1/10000)	5	4/4	Exposure time (exposurecontrol => manual)
gain	0~15 (0db ~ 28db)	5	4/4	Gain control (exposurecontrol => manual)
exposurecontrol	0~3	0	4/4	Select exposure mode. 0 => Auto with IRCut 1 => Shutter priority 2 => Iris priority 3 => Manual mode
exposurelevel	0~12	6	4/4	Exposure level
whitebalance	auto, manual	manual	4/4	"auto" indicates auto white balance. "manual" indicates keep current value.
rgain	0~100	52	4/4	Manual set rgain value of gain control setting.
bgain	0~100	47	4/4	Manual set bgain value of gain control setting.
wdr_mode	0~2	0	4/4	WDR enhanced. 0: off 1: manual 2: auto
wdr_shadowcorrectio n	0~2	1	4/4	WDR strength 0: low 1: medium 2: high
wdr_shortexposure	900,1800,2700,3 600,4500,5400,6 300,7200,8100,9 000	1	4/4	Short exposure time : "900" : 1/900 "1800" : 1/1800 "2700" : 1/2700 "3600" : 1/3600 "4500" : 1/4500 "5400" : 1/5400 "6300" : 1/6300

				"7200" : 1/7200 "8100" : 1/8100 "9000" : 1/9000 (wdr_mode : 1)
wdr_sensitivity	0~2	1	4/4	WDR strength 0: low 1: medium 2: high (wdr_mode: 2)

7.10 IR cut control

Group: **ircutcontrol** (capability.nvideoinprofile > 0)

NAME	VALUE	DEFAULT	SECURITY (get/set)	DESCRIPTION
daymodebegintime	00:00~23:59	07:00	6/6	Day mode begin time
daymodeendtime	00:00~23:59	18:00	6/6	Day mod end time
sensitivity	0~28	14	6/6	Sensitivity of IR cut filter
irdetection	0,1	0	6/6	IR light detection

7.11 Image setting per channel

Group: **image_c<0~(n-1)>** for n channel products

NAME	VALUE	DEFAULT	SECURITY (get/set)	DESCRIPTION
brightness	-5~5	-5	4/4	Adjust brightness of image according to mode settings.
contrast	-5 ~ 5	0	4/4	Adjust contrast of image according to mode settings.
sharpness	-3~3	0	4/4	Adjust sharpness of image according to mode settings.
profile_i0_enable	<boolean>	0	4/4	Enable/disable this profile setting
profile_i0_policy	day, night, schedule	night	4/4	The mode which the profile is applied to.
profile_i0_begintime	hh:mm	18:00	4/4	Begin time of schedule mode.
profile_i0_endtime	hh:mm	06:00	4/4	End time of schedule mode.
profile_i0_contrast	-5 ~ 5	0	4/4	Adjust contrast of image

				according to mode settings.
profile_i0_sharpness	-3~3	0	4/4	Adjust sharpness of image according to mode settings.

7.12 Image setting for preview

Group: **imagepreview_c<0~(n-1)>** for n channel products

NAME	VALUE	DEFAULT	SECURITY (get/set)	DESCRIPTION
brightness	-5~5	-5	4/4	Adjust brightness of image according to mode settings.
contrast	-5 ~ 5	0	4/4	Adjust contrast of image according to mode settings.
sharpness	-3~3	0	4/4	Adjust sharpness of image according to mode settings.

Group: imagepreview

NAME	VALUE	DEFAULT	SECURITY (get/set)	DESCRIPTION
videoin_whitebalance	auto, manual	auto	4/4	Preview of adjusting white balance of image according to mode settings
videoin_restoreatwb	0, 1~	0	4/4	Restore of adjusting white balance of image according to mode settings
videoin_rgain	0~100	0	4/4	Manual set rgain value of gain control setting.
videoin_bgain	0~100	0	4/4	Manual set bgain value of gain control setting.

7.13 Audio detection settings

Group: **audioin_c<0~(n-1)>** for n channel products (**capability.audioin>0**)

NAME	VALUE	DEFAULT	SECURITY (get/set)	DESCRIPTION
alarm_enable	0, 1	0	4/4	Enable audio detection
alarm_level	1~100	50	4/4	Audio detection alarm level

7.14 Audio input per channel

Group: **audioin_c<0~(n-1)>** for n channel products (**capability.audioin>0**)

NAME	VALUE	DEFAULT	SECURITY (get/set)	DESCRIPTION
mute	0, 1	0	4/4	Enable audio mute.
gain	1~100	69	4/4	Gain of input. (audioin_c<0~(n-1)>_source = linein)
s<0~(m-1)>_codectype	aac4, gamr, g711	aac4	4/4	Set audio codec type for input.
s<0~(m-1)>_aac4_bitrate <product dependent>	16000, 32000, 48000, 64000, 96000, 128000	16000	4/4	Set AAC4 bitrate in bps.
s<0~(m-1)>_gamr_bitrate <product dependent>	4750, 5150, 5900, 6700, 7400, 7950, 10200, 12200	12200	4/4	Set AMR bitrate in bps.
s<0~(m-1)>_g711_mode <product dependent>	pcmu, pcma	pcmu	4/4	Set G.711 mode.

7.15 Time Shift settings

Group: **timeshift**, c for n channel products, m is stream number (**capability.timeshift > 0**)

NAME	VALUE	DEFAULT	SECURITY (get/set)	DESCRIPTION
enable	<boolean>	0	4/4	Enable time shift streaming.
c<0~(n-1)>_s<0~(m-1)>_allow	<boolean>	0	4/4	Enable time shift streaming for specific stream.

7.16 Motion detection settings

Group: **motion_c<0~(n-1)>** for n channel product

NAME	VALUE	DEFAULT	SECURITY (get/set)	DESCRIPTION
enable	<boolean>	0	4/4	Enable motion detection.
win_i<0~2>_enable	<boolean>	0	4/4	Enable motion window 1~3.
win_i<0~2>_name	string[14]	<blank>	4/4	Name of motion window 1~3.
win_i<0~2>_left	0 ~ 320	0	4/4	Left coordinate of window position.
win_i<0~2>_top	0 ~ 240	0	4/4	Top coordinate of window position.
win_i<0~2>_width	0 ~ 320	0	4/4	Width of motion detection window.
win_i<0~2>_height	0 ~ 240	0	4/4	Height of motion detection window.
win_i<0~2>_objsize	0 ~ 100	0	4/4	Percent of motion detection window.
win_i<0~2>_sensitivity	0 ~ 100	0	4/4	Sensitivity of motion detection window.

Group: **motion_c<0~(n-1)> profile** for m profile and n channel product (capability.nmotionprofile > 0)

NAME	VALUE	DEFAULT	SECURITY (get/set)	DESCRIPTION
i<0~(m-1)>_enable	<boolean>	0	4/4	Enable profile 1 ~ (m-1).
i<0~(m-1)>_policy	day, night, schedule	night	4/4	The mode which the profile is applied to.
i<0~(m-1)>_begintime	hh:mm	18:00	4/4	Begin time of schedule mode.
i<0~(m-1)>_endtime	hh:mm	06:00	4/4	End time of schedule mode.
i<0~(m-1)>_win_i<0~2>_enable	<boolean>	0	4/4	Enable motion window.
i<0~(m-1)>_win_i<0~2>_name	string[14]	<blank>	4/4	Name of motion window.
i<0~(m-1)>_win_i<0~2>_left	0 ~ 320	0	4/4	Left coordinate

				of window position.
$i<0\sim(m-1)>_{\text{win}}i<0\sim 2>_{\text{top}}$	0 ~ 240	0	4/4	Top coordinate of window position.
$i<0\sim(m-1)>_{\text{win}}i<0\sim 2>_{\text{width}}$	0 ~ 320	0	4/4	Width of motion detection window.
$i<0\sim(m-1)>_{\text{win}}i<0\sim 2>_{\text{height}}$	0 ~ 240	0	4/4	Height of motion detection window.
$i<0\sim(m-1)>_{\text{win}}i<0\sim 2>_{\text{objsize}}$	0 ~ 100	0	4/4	Percent of motion detection window.
$i<0\sim(m-1)>_{\text{win}}i<0\sim 2>_{\text{sensitivity}}$	0 ~ 100	0	4/4	Sensitivity of motion detection window.

7.17 Tempering detection settings

Group: **tampering_c<0~(n-1)>** for n channel product (**capability.tampering > 0**)

NAME	VALUE	DEFAULT	SECURITY (get/set)	DESCRIPTION
enable	<boolean>	0	4/4	Enable or disable tamper detection.
threshold	0 ~ 255	32	4/4	Threshold of tamper detection.
duration	10 ~ 600	10	4/4	If tampering value exceeds the 'threshold' for more than 'duration' second(s), then tamper detection is triggered.

7.18 DDNS

Group: **ddns** (capability.ddns > 0)

NAME	VALUE	DEFAULT	SECURITY (get/set)	DESCRIPTION
enable	<boolean>	0	6/6	Enable or disable the dynamic DNS.
provider	Safe100, DyndnsDynamic, DyndnsCustom, TZO, DHS, DynInterfree, CustomSafe100, PeanutHull, IODATA, DO_JP, MYDNS_JP, customizeddyndns, DP21, NetHome, ADAMA_LAND, AddressNet, Luna_VC, Mars_VC, Planex_VC, Sun_VC, Nexus_Control, DO_JP_FREE, EPolice, PCCW, MegaChips, DLink, DLinkCN Logitec, GE_Security, HUAGAI, 3322, ALARM, ChangeIP,	DyndnsDyn amic	6/6	Safe100 => safe100.net DyndnsDynamic => dyndns.org (dynamic) DyndnsCustom => dyndns.org (custom) TZO => tzo.com DHS => dhs.org DynInterfree => dyn-interfree.it CustomSafe100 => Custom server using safe100 method PeanutHull => PeanutHull IODATA => iodata.jp DO JP => ddo.jp MYDNS JP => mydns.jp Customizeddyndns => Custom server using dyndns method DP21 => dp-21.net NetHome => NetHome Co.,Ltd ADAMA_LAND => non-functional service provider Address.net => non-functional service provider Luna_VC => cybergate ddns Mars_VC => cybergate ddns Planex_VC => cybergate ddns Sun_VC => cybergate ddns Nexus_Control => nexus control DO_JP_FREE => dp-21.net (free) Epolice => epolice.com.tw PCCW => pccw.com MegaChips => megachips.co.jp Dlink => D-LINK DlinkCN => D-LINK CN

	NOIP SWISSCOM CustomizedTZO <product dependent>			Logitec => logitec.co.jp GE_Security =>GE Security HUAGAI => huagai.com 3322 => 3322.net ALARM => alarm.com ChangeIP => TOSHIBA NOIP => TOSHIBA SWISSCOM =>swiss.com CustomizedTZO => Customized server using TZO method <product dependent>
<provider>_hostname	string[128]	<blank>	6/6	Your DDNS hostname.
<provider>_usernameemail	string[64]	<blank>	6/6	Your user name or email to login to the DDNS service provider
<provider>_passwordkey	string[64]	<blank>	6/6	Your password or key to login to the DDNS service provider.
<provider>_servername	string[128]	<blank>	6/6	The server name for safe100. (This field only exists if the provider is customsafel00)

7.19 Express link

Group: expresslink

PARAMETER	VALUE	Default	SECURITY (get/set)	DESCRIPTION
enable	<boolean>	0	6/6	Enable or disable express link.
state	onlycheck, onlyoffline, checkonline, badnetwork	NULL	6/6	Camera will check the status of network environment and express link URL
url	string[64]	NULL	6/6	The url user define to link to camera

7.20 UPnP presentation

Group: upnppresentation

NAME	VALUE	DEFAULT	SECURITY (get/set)	DESCRIPTION
enable	<boolean>	1	6/6	Enable or disable the UPnP presentation service.

7.21 UPnP port forwarding

Group: upnpportforwarding

NAME	VALUE	DEFAULT	SECURITY (get/set)	DESCRIPTION
enable	<boolean>	0	6/6	Enable or disable the UPnP port forwarding service.
upnpnatstatus	0~3	0	6/7	The status of UPnP port forwarding, used internally. 0 = OK, 1 = FAIL, 2 = no IGD router, 3 = no need for port forwarding

7.22 System log

Group: **syslog**

NAME	VALUE	DEFAULT	SECURITY (get/set)	DESCRIPTION
enableremotelog	<boolean>	0	6/6	Enable remote log.
serverip	<IP address>	<blank>	6/6	Log server IP address.
serverport	514, 1025~65535	514	6/6	Server port used for log.
level	0~7	6	6/6	Levels used to distinguish the importance of the information: 0: LOG_EMERG 1: LOG_ALERT 2: LOG_CRIT 3: LOG_ERR 4: LOG_WARNING 5: LOG_NOTICE

				6: LOG_INFO 7: LOG_DEBUG
setparamlevel	0~2	0	6/6	Show log of parameter setting. 0: disable 1: Show log of parameter setting set from external. 2. Show log of parameter setting set from external and internal.

7.23 camera PTZ control

Group: **camctrl_c<0~(n-1)>** for n channel product (**capability.ptzenabled**)

NAME	VALUE	DEFAULT	SECURITY (get/set)	DESCRIPTION
panspeed	-5 ~ 5	0	1/4	Pan speed
tiltspeed	-5 ~ 5	0	1/4	Tilt speed
zoomspeed	-5 ~ 5	0	1/4	Zoom speed
autospeed	-5 ~ 5	0	1/4	Auto pan speed
focusspeed	-5 ~ 5	0	1/4	Auto focus speed
preset_i<0~(npreset-1)>_name	string[40]	<blank>	1/4	Name of the preset location.
preset_i<0~127>_dwelling	0 ~ 255	<blank>	1/4	Dwelling time at each preset location.
patrol_i<0~39>_name	string[40]	<blank>	1/4	(For internal device) The name of patrol location
patrol_i<0~39>_dwelling	0 ~ 255	<blank>	1/4	(For internal device) The dwelling time of each patrol location
disablemdonptz	<boolean>	0	1/4	Disable motion detection on PTZ operation.
defaulthome	<boolean>	1	6/6	This field tells system to use default home position or not.
digitalzoom	<boolean>	0	6/6	Enable/disable digital zoom
idleaction_enable	<integer>	0	1/4	Enable/disable idle action

				while idle
idleaction_type	pan, patrol, home	pan	1/4	This field tells what kind of action should be taken while idle.
idleaction_interval	<integer>	30	1/4	While idle over this time interval, idle action will be taken.
horizontalalignment	<boolean>	0	1/4	Once you enable this feature, a reference line will be visible when the camera tilt is under 0° or over 180° to help verify that the camera is mounted to a flat surface.

7.25 SNMP

Group: **snmp** (capability.snmp > 0)

NAME	VALUE	DEFAULT	SECURITY (get/set)	DESCRIPTION
v2	0~1	0	6/6	SNMP v2 enabled. 0 for disable, 1 for enable
v3	0~1	0	6/6	SNMP v3 enabled. 0 for disable, 1 for enable
secnamerw	string[31]	Private	6/6	Read/write security name
secnamero	string[31]	Public	6/6	Read only security name
authpwrw	string[8~128]	<blank>	6/6	Read/write authentication password
authpwro	string[8~128]	<blank>	6/6	Read only authentication password
authtyperw	MD5,SHA	MD5	6/6	Read/write authentication type
authtypero	MD5,SHA	MD5	6/6	Read only authentication type
encryptpwrw	string[8~128]	<blank>	6/6	Read/write passwd
encryptpwro	string[8~128]	<blank>	6/6	Read only password
encrypttyperw	DES	DES	6/6	Read/write encryption type
encrypttypero	DES	DES	6/6	Read only encryption type
rwcommunity	string[31]	Private	6/6	Read/write community

rocommunity	string[31]	Public	6/6	Read only community
syslocation	0~128	<blank>	6/6	System location
syscontact	0~128	<blank>	6/6	System contact

7.26 Layout configuration

Group: **layout** (New version)

NAME	VALUE	DEFAULT	SECURITY (get/set)	DESCRIPTION
logo_default	<boolean>	1	1/6	0 => Custom logo 1 => Default logo
logo_link	string[40]	http://www.vivotek.com	1/6	Hyperlink of the logo
logo_powerbyvvtk_hidden	<boolean>	0	1/6	0 => display the power by vivotek logo 1 => hide the power by vivotek logo
custombutton_manualtrigger_s how <product dependent>	<boolean>	1	1/6	Show or hide manual trigger (VI) button in homepage 0 -> Hidden 1 -> Visible
theme_option	1~4	1	1/6	1~3: One of the default themes. 4: Custom definition.
theme_color_font	string[7]	#ffffff	1/6	Font color
theme_color_configfont	string[7]	#ffffff	1/6	Font color of configuration area.
theme_color_titlefont	string[7]	#098bd6	1/6	Font color of video title.
theme_color_controlbackground	string[7]	#565656	1/6	Background color of control area.
theme_color_configbackground	string[7]	#323232	1/6	Background color of configuration area.
theme_color_videobackground	string[7]	#565656	1/6	Background color of video area.
theme_color_case	string[7]	#323232	1/6	Frame color

7.27 Privacy mask

Group: **privacymask3d_c<0~(n-1)>** for n channel product

NAME	VALUE	DEFAULT	SECURITY (get/set)	DESCRIPTION
enable	<boolean>	0	4/4	Enable the 3D privacy mask
color	0~14	0	4/4	Privacy mask color

7.28 Capability

Group: capability

NAME	VALUE	DEFAULT	SECURITY (get/set)	DESCRIPTION
api_httpversion	<string>	0100a	0/7	The HTTP API version.
bootuptime	<positive integer>	60	0/7	Server bootup time.
nir	0, <positive integer>	0	0/7	Number of IR interfaces. (Recommend to use ir for built-in IR and extir for external IR)
npir	0, <positive integer>	0	0/7	Number of PIRs.
ndi	0, <positive integer>	1	0/7	Number of digital inputs.
nvi	0, <positive integer>	3	0/7	Number of virtual inputs (manual trigger)
ndo	0, <positive integer>	1	0/7	Number of digital outputs.
naudioin	0, <positive integer>	1	0/7	Number of audio inputs.
naudioout	0, <positive integer>	1	0/7	Number of audio outputs.

	integer>			
nvideoin	<positive integer>	1	0/7	Number of video inputs.
nmediastream	<positive integer>	4	0/7	Number of media stream per channels.
nvideosetting	<positive integer>	2	0/7	Number of video settings per channel.
naudiosetting	<positive integer>	1	0/7	Number of audio settings per channel.
nuart	0, <positive integer>	1	0/7	Number of UART interfaces.
nvideoinprofile	<positive integer>	1	0/7	Number of video input profiles.
nmotionprofile	0, <positive integer>	1	0/7	Number of motion profiles.
ptzenabled	0, <positive integer>	189	0/7	<p>An 32-bit integer, each bit can be set separately as follows:</p> <p>Bit 0 => Support camera control function; 0(not support), 1(support)</p> <p>Bit 1 => Built-in or external camera; 0(external), 1(built-in)</p> <p>Bit 2 => Support pan operation, 0(not support), 1(support)</p> <p>Bit 3 => Support tilt operation; 0(not support), 1(support)</p> <p>Bit 4 => Support zoom operation; 0(not support), 1(support)</p> <p>Bit 5 => Support focus operation; 0(not support), 1(support)</p> <p>Bit 6 => Support iris operation;</p>

				0(not support), 1(support) Bit 7 => External or built-in PT; 0(built-in), 1(external) Bit 8 => Invalidate bit 1 ~ 7; 0(bit 1 ~ 7 are valid), 1(bit 1 ~ 7 are invalid) Bit 9 => Reserved bit; Invalidate lens_pan, Lens_tilt, lens_zoon, lens_focus, len_iris. 0(fields are valid), 1(fields are invalid)
evctrlchannel	<boolean>	1	0/7	Indicate whether to support HTTP tunnel for event/control transfer.
joystick	<boolean>	1	0/7	Indicate whether to support joystick control.
storage_dbenabled	<boolean>	1	0/7	Media files are indexed in database.
ptzenabledclient	<boolean>	0	0/7	Indicate whether to support ptz client
protocol_https	< boolean >	1	0/7	Indicate whether to support HTTP over SSL.
protocol_rtsp	< boolean >	1	0/7	Indicate whether to support RTSP.
protocol_sip	<boolean>	1	0/7	Indicate whether to support SIP.
protocol_maxconnection	<positive integer>	10	0/7	The maximum allowed simultaneous connections.
protocol_maxgenconnection	<positive integer>	10	0/7	The maximum general streaming connections .
protocol_maxmegaconnection	<positive integer>	0	0/7	The maximum megapixel streaming connections.
protocol_rtp_multicast_scalable	<boolean>	1	0/7	Indicate whether to support scalable multicast.
protocol_rtp_multicast_backchannel	<boolean>	0	0/7	Indicate whether to support backchannel multicast.
protocol_rtp_tcp	<boolean>	1	0/7	Indicate whether to support RTP over TCP.

protocol_rtp_http	<boolean>	1	0/7	Indicate whether to support RTP over HTTP.
protocol_spush_mjpeg	<boolean>	1	0/7	Indicate whether to support server push MJPEG.
protocol_snmp	<boolean>	1	0/7	Indicate whether to support SNMP.
protocol_ipv6	<boolean>	1	0/7	Indicate whether to support IPv6.
videoin_type	0, 1, 2	2	0/7	0 => Interlaced CCD 1 => Progressive CCD 2 => CMOS
videoin_resolution	<a list of available resolution separated by commas> <product dependent>	QCIF, CIF, 4CIF, D1	0/7	Available resolutions list.
videoin_maxframerate	<a list of available maximum frame rate separated by commas> <product dependent>	30, 30, 30, 30, 30, 30	0/7	Available maximum frame list.
videoin_codec	mpeg4. mjpeg, h264 <product dependent>	mpeg4, mjpeg, h264	0/7	Available codec list.
videoout_codec	<a list of the available codec types separated by commas)> <product dependent>	<blank>	0/7	Available codec list.
audio_aec	<boolean>	0	0/7	Indicate whether to support acoustic echo cancellation.
audio_extmic	<boolean>	1	0/7	Indicate whether to support external microphone input.

audio_linein	<boolean>	1	0/7	Indicate whether to support external line input. (It will be replaced by audio_mic and audio_extmic.)
audio_lineout	<boolean>	1	0/7	Indicate whether to support line output.
audio_headphoneout	<boolean>	0	0/7	Indicate whether to support headphone output.
audioin_codec	aac4, gamr, g711 <product dependent>	aac4, gamr, g711	0/7	Available codec list for audio input.
audioout_codec	g711 <product dependent>	g711	0/7	Available codec list for SIP.
camctrl_httpstunnel	<boolean>	0	0/7	Indicate whether to support httpstunnel.
camctrl_httpstunnelclient	<boolean>	0	0/7	Indicate whether to support httpstunnel client.
camctrl_privilege	<boolean>	1	0/7	Indicate whether to support "Manage Privilege" of PTZ control in the Security page. 1: support both /cgi-bin/camctrl/camctrl.cgi and /cgi-bin/viewer/camctrl.cgi 0: support only /cgi-bin/viewer/camctrl.cgi
uart_httpstunnel	<boolean>	0	0/7	Indicate whether to support HTTP tunnel for UART transfer.
transmission_mode	Tx, Rx, Both	Tx	0/7	Indicate transmission mode of the machine: TX = server, Rx = receiver box, Both = DVR.
network_wire	<boolean>	1	0/7	Indicate whether to support Ethernet.
network_wireless	<boolean>	0	0/7	Indicate whether to support wireless.

wireless_s802dot11b	<boolean>	0	0/7	Indicate whether to support wireless 802.11b+.
wireless_s802dot11g	<boolean>	0	0/7	Indicate whether to support wireless 802.11g.
wireless_encrypt_wep	<boolean>	0	0/7	Indicate whether to support wireless WEP.
wireless_encrypt_wpa	<boolean>	0	0/7	Indicate whether to support wireless WPA.
wireless_encrypt_wpa2	<boolean>	0	0/7	Indicate whether to support wireless WPA2.
wireless_beginchannel	1 ~ 14	255	0/7	Indicate the begin channel of wireless network
wireless_endchannel	1 ~ 14	255	0/7	Indicate the end channel of wireless network
derivative_brand	<boolean>	1	0/7	Indicate whether to support the upgrade function for the derivative brand. For example, if the value is true, the VVTK product can be upgraded to VVXX. (TCVV<->TCXX is excepted)
npreset	0, <positive integer>	20	0/7	Number of preset locations
eptz	0, <positive integer>	7	0/7	A 32-bit integer, each bit can be set separately as follows: Bit 0 => stream 1 supports ePTZ or not. Bit 1 => stream 2 supports ePTZ or not. The rest may be deduced by analogy
nanystream	0, <positive integer>	1	0/7	number of any media stream per channel
iva	<boolean>	0	0/7	Indicate whether to support Intelligent Video analysis
tampering	<boolean>	1	0/7	Indicate whether to support tampering detection.

test_ac	<boolean>	1	0/7	Indicate whether to support test ac key.
version_onvifdaemon	<string>	1.5.0.0	0/7	Indicate ONVIF daemon version
image_wdrc	<Boolean>	0	0/7	Indicate whether to support WDR enhanced.
image_iris_type	<string>	piris, dciris	0/7	Indicate iris type.
image_focusassist	<Boolean>	0	0/7	Indicate whether to support focus assist.

7.29 Customized event script

Group: event_customtaskfile_i<0~2>

PARAMETER	VALUE	Default	SECURITY (get/set)	DESCRIPTION
name	string[41]	<blank>	6/7	Custom script identification of this entry.
date	string[17]	<blank>	6/7	Date of custom script.
time	string[17]	<blank>	6/7	Time of custom script.

7.30 Event setting

Group: **event_i**<0~2>

PARAMETER	VALUE	Default	SECURITY (get/set)	DESCRIPTION
name	string[40]	<blank>	6/6	Identification of this entry.
enable	0, 1	0	6/6	Enable or disable this event.
priority	0, 1, 2	1	6/6	Indicate the priority of this event: "0" = low priority "1" = normal priority "2" = high priority
delay	1~999	20	6/6	Delay in seconds before detecting the next event.
trigger	boot, di, motion, seq, reconfirm, volalarm	boot	6/6	Indicate the trigger condition: "boot" = System boot "di" = Digital input "motion" = Video motion detection "seq" = Periodic condition "reconfirm" = Recording notification. "volalarm" = Audio detection.
triggerstatus	String[40]	trigger	6/6	The status for event trigger
di	<integer>	1	6/6	Indicate the source id of di trigger. This field is required when trigger condition is "di". One bit represents one digital input. The LSB indicates DI 0.
mdwin	<integer>	0	6/6	Indicate the source window id of motion detection. This field is required when trigger condition is "md". One bit represents one window. The LSB indicates the 1 st window. For example, to detect the 1 st and 3 rd windows, set mdwin as 5.
mdwin0	<integer>	0	6/6	Similar to mdwin. The parameter takes effect when profile 1 of motion detection is enabled.

inter	1~999	1	6/6	Interval of snapshots in minutes. This field is used when trigger condition is "seq".
weekday	0~127	127	6/6	Indicate which weekday is scheduled. One bit represents one weekday. bit0 (LSB) = Saturday bit1 = Friday bit2 = Thursday bit3 = Wednesday bit4 = Tuesday bit5 = Monday bit6 = Sunday For example, to detect events on Friday and Sunday, set weekday as 66.
begintime	hh:mm	00:00	6/6	Begin time of the weekly schedule.
endtime	hh:mm	24:00	6/6	End time of the weekly schedule. (00:00 ~ 24:00 sets schedule as always on)
action_do_i<0~(ndo-1)>_enable	0, 1	0	6/6	Enable or disable trigger digital output.
action_do_i<0~(ndo-1)>_duration	1~999	1	6/6	Duration of the digital output trigger in seconds.
action_goto_enable <product dependent>	<Boolean>	0	6/6	Enable/disable ptz goto preset position on event triggered.
action_goto_name <product dependent>	string[40]	<blank>	6/6	Specify the preset name that ptz goto on event triggered.
action_cf_enable	<Boolean>	0	6/6	Enable or disable sending media to SD card.
action_cf_folder	string[128]	<blank>	6/6	Path to store media.
action_cf_media	NULL, 0~4	<blank>	6/6	Index of the attached media.
action_cf_datefolder	<boolean>	0	6/6	Enable this to create folders by date, time, and hour automatically.
action_cf_backup	<Boolean>	0	6/6	Enable or disable the function that send media to SD card for backup if network is disconnected.
action_server_i<0~4>_enable	0, 1	0	6/6	Enable or disable this server action.

action_server_i<0~4>_media	NULL, 0~4	<blank>	6/6	Index of the attached media.
action_server_i<0~4>_datefolder	<boolean>	0	6/6	Enable this to create folders by date, time, and hour automatically.
action_patrol_enable (only for VS series) <product dependent>	<Boolean>	0	6/6	Enable/disable ptz patrol when event triggered.
action_patrol_server (only for VS series) <product dependent>	0~255	0	6/6	Indicate the target servers to which the snapshots taken during patrol dwelling time should be sent. One bit represents one application server (server_i0~i4). bit0 (LSB) = server_i0. bit1 = server_i1. bit2 = server_i2. bit3 = server_i3. bit4 = server_i4. For example, enable server_i0, server_i2, and server_i4 as notification servers; the notifyserver value is 21.

7.31 Server setting for event action

Group: **server_i<0~4>**

PARAMETER	VALUE	DEFAULT	SECURITY (get/set)	DESCRIPTION
name	string[40]	NULL	6/6	Identification of this entry
type	email, ftp, http, ns	email	6/6	Indicate the server type: "email" = email server "ftp" = FTP server "http" = HTTP server "ns" = network storage
http_url	string[128]	http://	6/6	URL of the HTTP server to upload.
http_username	string[64]	NULL	6/6	Username to log in to the server.
http_passwd	string[64]	NULL	6/6	Password of the user.
ftp_address	string[128]	NULL	6/6	FTP server address.
ftp_username	string[64]	NULL	6/6	Username to log in to the server.

ftp_passwd	string[64]	NULL	6/6	Password of the user.
ftp_port	0~65535	21	6/6	Port to connect to the server.
ftp_location	string[128]	NULL	6/6	Location to upload or store the media.
ftp_passive	0, 1	1	6/6	Enable or disable passive mode. 0 = disable passive mode 1 = enable passive mode
email_address	string[128]	NULL	6/6	Email server address.
email_sslmode	0, 1	0	6/6	Enable support SSL.
email_port	0~65535	25	6/6	Port to connect to the server.
email_username	string[64]	NULL	6/6	Username to log in to the server.
email_passwd	string[64]	NULL	6/6	Password of the user.
email_senderemail	string[128]	NULL	6/6	Email address of the sender.
email_recipientemail	string[128]	NULL	6/6	Email address of the recipient.
ns_location	string[128]	NULL	6/6	Location to upload or store the media.
ns_username	string[64]	NULL	6/6	Username to log in to the server.
ns_passwd	string[64]	NULL	6/6	Password of the user.
ns_workgroup	string[64]	NULL	6/6	Workgroup for network storage.

7.32 Media setting for event action

Group: **media_i<0~4>** (media_freespace is used internally.)

PARAMETER	VALUE	DEFAULT	SECURITY (get/set)	DESCRIPTION
name	string[40]	NULL	6/6	Identification of this entry
type	snapshot, systemlog, videoclip, recordmsg	snapshot	6/6	Media type to send to the server or store on the server.
snapshot_source	<integer>	0	6/6	Indicate the source of media stream. 0 means the first stream. 1 means the second stream and etc. 2 means the third stream and etc. 3 means the fourth stream and etc.

snapshot_prefix	string[16]	Snapshot1_	6/6	Indicate the prefix of the filename. media_i0=> Snapshot1_ media_i1=> Snapshot2_ media_i2=> Snapshot3_ media_i3=> Snapshot4_ media_i4=> Snapshot5_
snapshot_datesuffix	0, 1	0	6/6	Add date and time suffix to filename: 1 = Add date and time suffix. 0 = Do not add.
snapshot_preevent	0 ~ 7	1	6/6	Indicates the number of pre-event images.
snapshot_postevent	0 ~ 7	1	6/6	The number of post-event images.
videoclip_source	<integer>	0	6/6	Indicate the source of media stream. 0 means the first stream. 1 means the second stream and etc. 2 means the third stream and etc. 3 means the fourth stream and etc.
videoclip_prefix	string[16]	VideoClip1_	6/6	Indicate the prefix of the filename.
videoclip_preevent	0 ~ 9	0	6/6	Indicates the time for pre-event recording in seconds.
videoclip_maxduration	1 ~ 20	5	6/6	Maximum duration of one video clip in seconds.
videoclip_maxsize	50 ~ 4096	1000	6/6	Maximum size of one video clip file in Kbytes.

7.33 Recording

Group: **recording_i**<0~1>

PARAMETER	VALUE	DEFAULT	SECURITY (get/set)	DESCRIPTION
name	string[40]	NULL	6/6	Identification of this entry.
trigger	schedule, networkfail	schedule	6/6	The event trigger type schedule: The event is triggered by schedule networkfail: The event is triggered by the failure of network connection.
enable	0, 1	0	6/6	Enable or disable this recording.

priority	0, 1, 2	1	6/6	Indicate the priority of this recording: "0" indicates low priority. "1" indicates normal priority. "2" indicates high priority.
source	0~3	0	6/6	Indicate the source of media stream. 0 means the first stream. 1 means the second stream and so on.
limitsize	0,1	0	6/6	0: Entire free space mechanism 1: Limit recording size mechanism
cyclic	0,1	0	6/6	0: Disable cyclic recording 1: Enable cyclic recording
notify	0,1	1	6/6	0: Disable recording notification 1: Enable recording notification
notifyserver	0~31	0	6/6	Indicate which notification server is scheduled. One bit represents one application server (server_i0~i4). bit0 (LSB) = server_i0. bit1 = server_i1. bit2 = server_i2. bit3 = server_i3. bit4 = server_i4. For example, enable server_i0, server_i2, and server_i4 as notification servers; the notifyserver value is 21.
weekday	0~127	127	6/6	Indicate which weekday is scheduled. One bit represents one weekday. bit0 (LSB) = Saturday bit1 = Friday bit2 = Thursday bit3 = Wednesday bit4 = Tuesday bit5 = Monday bit6 = Sunday For example, to detect events on Friday and Sunday, set weekday as 66.
begintime	hh:mm	00:00	6/6	Start time of the weekly schedule.

endtime	hh:mm	24:00	6/6	End time of the weekly schedule. (00:00~24:00 indicates schedule always on)
prefix	string[16]	<blank>	6/6	Indicate the prefix of the filename.
cyclesize	200~	100	6/6	The maximum size for cycle recording in Kbytes when choosing to limit recording size.
reserveamount	0~	100	6/6	The reserved amount in Mbytes when choosing cyclic recording mechanism.
dest	cf, 0~4	cf	6/6	The destination to store the recorded data. "cf" means local storage (CF or SD card). "0" means the index of the network storage.
cffolder	string[128]	NULL	6/6	Folder name.
adaptive_enable <product dependent>	0,1	0	6/6	Indicate whether the adaptive recording is enabled
adaptive_preevent <product dependent>	0~9	1	6/6	Indicate when is the adaptive recording started before the event trigger point (seconds)
adaptive_postevent <product dependent>	0~10	1	6/6	Indicate when is the adaptive recording stopped after the event trigger point (seconds)

7.34 HTTPS

Group: **https** (capability.protocol.https > 0)

NAME	VALUE	DEFAULT	SECURITY (get/set)	DESCRIPTION
enable	<boolean>	0	6/6	To enable or disable secure HTTP.
policy	<Boolean>	0	6/6	If the value is 1, it will force HTTP connection redirect to HTTPS connection
method	auto, manual, install	auto	6/6	auto => Create self-signed certificate automatically. manual => Create self-signed certificate manually.

				install => Create certificate request and install.
status	-3 ~ 1	0	6/7	Specify the https status. -3 = Certificate not installed -2 = Invalid public key -1 = Waiting for certificate 0 = Not installed 1 = Active
countryname	string[2]	TW	6/6	Country name in the certificate information.
stateorprovincename	string[128]	Asia	6/6	State or province name in the certificate information.
localityname	string[128]	Asia	6/6	The locality name in the certificate information.
organizationname	string[64]	Vivotek.Inc	6/6	Organization name in the certificate information.
unit	string[32]	Vivotek.Inc	6/6	Organizational unit name in the certificate information.
commonname	string[64]	www.vivotek.com	6/6	Common name in the certificate information.
validdays	0 ~ 3650	3650	6/6	Valid period for the certification.

7.35 Storage management setting

Currently it's for local storage (SD, CF card)

Group: **disk_i<0~(n-1)>** n is the total number of storage devices. (**capability.storage.dbenabled > 0**)

PARAMETER	VALUE	Default	SECURITY (get/set)	DESCRIPTION
cyclic_enabled	<boolean>	0	6/6	Enable cyclic storage method.
autocleanup_enabled	<boolean>	0	6/6	Enable automatic clean up method. Expired and not locked media files will be deleted.
autocleanup_maxage	<positive integer>	7	6/6	To specify the expired days for automatic clean up.

8. Useful Functions

8.1 Drive the Digital Output (**capability.ndo > 0**)

Note: This request requires Viewer privileges.

Method: GET/POST

Syntax:

```
http://<servername>/cgi-bin/dido/setdo.cgi?do1=<state>[&do2=<state>]
[&do3=<state>][&do4=<state>]
```

Where state is 0 or 1; "0" means inactive or normal state, while "1" means active or triggered state.

PARAMETER	VALUE	DESCRIPTION
do<num>	0, 1	0 - Inactive, normal state
		1 - Active, triggered state

Example: Drive the digital output 1 to triggered state and redirect to an empty page.

<http://myserver/cgi-bin/dido/setdo.cgi?do1=1>

8.2 Query Status of the Digital Input (**capability.ndi > 0**)

Note: This request requires Viewer privileges

Method: GET/POST

Syntax:

```
http://<servername>/cgi-bin/dido/getdi.cgi?[di0][&di1][&di2][&di3]
```

If no parameter is specified, all of the digital input statuses will be returned.

Return:

```
HTTP/1.0 200 OK\r\n
Content-Type: text/plain\r\n
Content-Length: <length>\r\n
\r\n
[di0=<state>]\r\n
[di1=<state>]\r\n
[di2=<state>]\r\n
[di3=<state>]\r\n
```

where <state> can be 0 or 1.

Example: Query the status of digital input 1 .

Request:

```
http://myserver/cgi-bin/dido/getdi.cgi?di1
```

Response:

```
HTTP/1.0 200 OK\r\n
Content-Type: text/plain\r\n
Content-Length: 7\r\n
\r\n
di1=1\r\n
```

8.3 Query Status of the Digital Output (**capability.ndo > 0**)

Note: This request requires Viewer privileges

Method: GET/POST

Syntax:

```
http://<servername>/cgi-bin/dido/getdo.cgi?[do0][&do1][&do2][&do3]
```

If no parameter is specified, all the digital output statuses will be returned.

Return:

```
HTTP/1.0 200 OK\r\n
Content-Type: text/plain\r\n
Content-Length: <length>\r\n
\r\n
[do0=<state>]\r\n
[do1=<state>]\r\n
[do2=<state>]\r\n
[do3=<state>]\r\n
```

where *<state>* can be 0 or 1.

Example: Query the status of digital output 1.

Request:

<http://myserver/cgi-bin/dido/getdo.cgi?do1>

Response:

```
HTTP/1.0 200 OK\r\n
Content-Type: text/plain\r\n
Content-Length: 7\r\n
\r\n
do1=1\r\n
```

8.4 3D Privacy Mask

Note: This request requires admin user privilege

<SD81X1> You can set privacy mask only at zoom 1x. To go back to zoom 1x directly, please send this cgi command: "/cgi-bin/camctrl/camposition.cgi?setzoom=0"

Method: GET/POST

Syntax:

http://<servername>/cgi-bin/admin/setpm3d.cgi?method=<value>&name=<value>&[maskheight=<value>&maskwidth=<value>&return=<return page>]

PARAMETER	VALUE	DESCRIPTION
method	add	Add a 3D privacy mask at current location
	delete	Delete a 3D privacy mask
	edit	Edit a 3D privacy mask
maskname	string[40]	3D privacy mask name
maskheight	integer	3D privacy mask height
maskwidth	integer	3D privacy mask width
return	<return page>	Redirect to page <return page> after the 3D privacy mask is configured. The <return page> can be a full URL path or relative path according to the current path. If you omit this parameter, it will redirect to an empty page.

8.5 Capture Single Snapshot

Note: This request requires Normal User privileges.

Method: GET/POST

Syntax:

```
http://<servername>/cgi-bin/viewer/video.jpg?[channel=<value>][&resolution=<value>]
[&quality=<value>][&streamid=<value>]
```

If the user requests a size larger than all stream settings on the server, this request will fail.

PARAMETER	VALUE	DEFAULT	DESCRIPTION
channel	0~(n-1)	0	The channel number of the video source.
resolution	<available resolution>	0	The resolution of the image.
quality	1~5	3	The quality of the image.
streamid	0~(m-1)	<product dependent>	The stream number.

The server will return the most up-to-date snapshot of the selected channel and stream in JPEG format. The size and quality of the image will be set according to the video settings on the server.

Return:

```
HTTP/1.0 200 OK\r\n
Content-Type: image/jpeg\r\n
[Content-Length: <image size>\r\n]

<binary JPEG image data>
```

8.6 Account Management

Note: This request requires Administrator privileges.

Method: GET/POST

Syntax:

```
http://<servername>/cgi-bin/admin/editaccount.cgi?
method=<value>&username=<name>[&userpass=<value>][&privilege=<value>]
[&privilege=<value>][...][&return=<return page>]
```

PARAMETER	VALUE	DESCRIPTION
method	Add	Add an account to the server. When using this method, the "username" field is necessary. It will use the default value of other fields if not specified.
	Delete	Remove an account from the server. When using this method, the "username" field is necessary, and others are ignored.
	edit	Modify the account password and privilege. When using this method, the "username" field is necessary, and other fields are optional. If not specified, it will keep the original settings.
username	<name>	The name of the user to add, delete, or edit.
userpass	<value>	The password of the new user to add or that of the old user to modify. The default value is an empty string.
Privilege	<value>	The privilege of the user to add or to modify.
	viewer	Viewer privilege.
	operator	Operator privilege.
	admin	Administrator privilege.
Return	<return page>	Redirect to the page <return page> after the parameter is assigned. The <return page> can be a full URL path or relative path according to the current path. If you omit this parameter, it will redirect to an empty page.

8.7 System Logs

Note: This request require Administrator privileges.

Method: GET/POST

Syntax:

```
http://<servername>/cgi-bin/admin/syslog.cgi
```

Server will return the most up-to-date system log.

Return:

```
HTTP/1.0 200 OK\r\n
Content-Type: text/plain\r\n
Content-Length: <syslog length>\r\n
\r\n
<system log information>\r\n
```

8.8 Upgrade Firmware

Note: This request requires Administrator privileges.

Method: POST

Syntax:

```
http://<servername>/cgi-bin/admin/upgrade.cgi
```

Post data:

```
fimage=<file name>[&return=<return page>]\r\n
\r\n
<multipart encoded form data>
```

Server will accept the file named <file name> to upgrade the firmware and return with <return page> if indicated.

8.9 Camera Control (capability.ptzenabled)

Note: This request requires Viewer privileges.

Method: GET/POST

Syntax:

```
http://<servername>/cgi-bin/camctrl/camctrl.cgi?[channel=<value>][&camid=<value>]
[&move=<value>] - Move home, up, down, left, right
[&focus=<value>] - Focus operation
[&iris=<value>] - Iris operation
[&auto=<value>] - Auto pan, patrol
[&zoom=<value>] - Zoom in, out
[&zooming=<value>&zs=<value>] - Zoom without stopping, used for joystick
[&vx=<value>&vy=<value>&vs=<value>] - Shift without stopping, used for joystick
[&x=<value>&y=<value>&videosize=<value>&resolution=<value>&stretch=<value>] - Click on image
(Move the center of image to the coordination (x,y) based on resolution or videosize.)
[ [&speedpan=<value>][&speedtilt=<value>][&speedzoom=<value>][&speedapp=<value>][&speedlink
=<value>] ] - Set speeds
[&return=<return page>]
```

Example:

```
http://myserver/cgi-bin/camctrl/camctrl.cgi?channel=0&camid=1&move=right
http://myserver/cgi-bin/camctrl/camctrl.cgi?channel=0&camid=1&zoom=tele
http://myserver/cgi-bin/camctrl/camctrl.cgi?channel=0&camid=1&x=300&y=200&resolution=704x480&vi
deosize=704x480&strech=1
```

PARAMETER	VALUE	DESCRIPTION
channel	<0~(n-1)>	Channel of video source.
camid	0,<positive integer>	Camera ID.
move	home	Move to camera to home position.
	up	Move camera up.
	down	Move camera down.
	left	Move camera left.
	right	Move camera right.
speedpan	-5 ~ 5	Set the pan speed.
speedtilt	-5 ~ 5	Set the tilt speed.
speedzoom	-5 ~ 5	Set the zoom speed.

speedfocus	-5 ~ 5	Set the focus speed.
speedapp	-5 ~ 5	Set the auto pan/patrol speed.
auto	pan	Auto pan.
	patrol	Auto patrol.
	stop	Stop camera.
zoom	wide	Zoom larger view with current speed.
	tele	Zoom further with current speed.
	stop	Stop zoom.
zooming	wide or tele	Zoom without stopping for larger view or further view with zs speed, used for joystick control.
zs	0 ~ 6 0 ~ 15 <SD81X1> 0 ~ 8 < SD83X1_X2_X3>	Set the speed of zooming, "0" means stop.
vx	<integer , excluding 0>	The slope of movement = v_y/v_x , used for joystick control.
vy	<integer>	
vs	0 ~ 7 0 ~ 15 <SD81X1> 0 ~ 45 < SD83X1_X2_X3>	Set the speed of movement, "0" means stop.
x	<integer>	x-coordinate clicked by user. It will be the x-coordinate of center after movement.
y	<integer>	y-coordinate clicked by user. It will be the y-coordinate of center after movement.
videosize	<window size>	The size of plug-in (ActiveX) window in web page
resolution	<window size>	The resolution of streaming.
stretch	<boolean>	0 indicates that it uses resolution (streaming size) as the range of the coordinate system. 1 indicates that it uses videosize (plug-in size) as the range of the coordinate system.
focus	auto	Auto focus.
	far	Focus on further distance.
	near	Focus on closer distance.

return	<return page>	Redirect to the page <return page> after the parameter is assigned. The <return page> can be a full URL path or relative path according to the current path. If you omit this parameter, it will redirect to an empty page.
--------	---------------	---

8.10 ePTZ Camera Control (**capability.eptz > 0**)

Note: This request requires camctrl privileges.

Method: GET/POST

Syntax:

```

http://<servername>/cgi-bin/camctrl/eCamCtrl.cgi?channel=<value>&stream=<value>
[&move=<value>] - Move home, up, down, left, right
[&auto=<value>] - Auto pan, patrol
[&zoom=<value>] - Zoom in, out
[&zooming=<value>&zs=<value>] - Zoom without stopping, used for joystick
[&vx=<value>&vy=<value>&vs=<value>] - Shift without stopping, used for joystick
[&x=<value>&y=<value>&videosize=<value>&resolution=<value>&stretch=<value>] - Click on image
(Move the center of image to the coordination (x,y) based on resolution or videosize.)
[ [&speedpan=<value>][&speedtilt=<value>][&speedzoom=<value>][&speedapp=<value>] ] - Set
speeds
[&return=<return page>]
    
```

Example:

```

http://myserver/cgi-bin/camctrl/eCamCtrl.cgi?channel=0&stream=0&move=right
http://myserver/cgi-bin/camctrl/eCamCtrl.cgi?channel=0&stream=1&vx=2&vy=2&vz=2
http://myserver/cgi-bin/camctrl/eCamCtrl.cgi?channel=0&stream=1&x=100&y=100&videosize=640x480&resolution=640x480&stretch=0
    
```

PARAMETER	VALUE	DESCRIPTION
channel	<0~(n-1)>	Channel of video source.
stream	<0~(m-1)>	Stream.
move	home	Move to home ROI.
	up	Move up.
	down	Move down.
	left	Move left.
	right	Move right.
auto	pan	Auto pan.

	patrol	Auto patrol.
	stop	Stop auto pan/patrol.
zoom	wide	Zoom larger view with current speed.
	tele	Zoom further with current speed.
zooming	wide or tele	Zoom without stopping for larger view or further view with zs speed, used for joystick control.
zs	0 ~ 6	Set the speed of zooming, "0" means stop.
vx	<integer>	The direction of movement, used for joystick control.
vy	<integer>	
vs	0 ~ 7	Set the speed of movement, "0" means stop.
x	<integer>	x-coordinate clicked by user. It will be the x-coordinate of center after movement.
y	<integer>	y-coordinate clicked by user. It will be the y-coordinate of center after movement.
videosize	<window size>	The size of plug-in (ActiveX) window in web page
resolution	<window size>	The resolution of streaming.
stretch	<boolean>	0 indicates that it uses resolution (streaming size) as the range of the coordinate system. 1 indicates that it uses videosize (plug-in size) as the range of the coordinate system.
speedpan	-5 ~ 5	Set the pan speed.
speedtilt	-5 ~ 5	Set the tilt speed.
speedzoom	-5 ~ 5	Set the zoom speed.
speedapp	1 ~ 5	Set the auto pan/patrol speed.
return	<return page>	Redirect to the page <return page> after the parameter is assigned. The <return page> can be a full URL path or relative path according to the current path.

8.11 Recall (capability.ptzenabled)

Note: This request requires Viewer privileges.

Method: GET

Syntax:

```
http://<servername>/cgi-bin/viewer/recall.cgi?
recall=<value>[&channel=<value>][&return=<return page>]
```

PARAMETER	VALUE	DESCRIPTION
recall	Text string less than 30 characters	One of the present positions to recall.
channel	<0~(n-1)>	Channel of the video source.
return	<return page>	Redirect to the page <return page> after the parameter is assigned. The <return page> can be a full URL path or relative path according to the current path. If you omit this parameter, it will redirect to an empty page.

8.12 ePTZ Recall (capability.eptz > 0)

Note: This request requires camctrl privileges.

Method: GET/POST

Syntax:

```
http://<servername>/cgi-bin/camctrl/eRecall.cgi?channel=<value>&stream=<value>&recall=<value>[&return=<return page>]
```

PARAMETER	VALUE	DESCRIPTION
channel	<0~(n-1)>	Channel of the video source.
stream	<0~(m-1)>	Stream.
recall	Text string less than 40 characters	One of the present positions to recall.
return	<return page>	Redirect to the page <return page> after the parameter is assigned. The <return page> can be a full URL path or relative path according to the current path.

8.13 Preset Locations (capability.ptzenabled)

Note: This request requires Operator privileges.

Method: GET/POST

Syntax:

```
http://<servername>/cgi-bin/operator/preset.cgi?[channel=<value>][&addpos=<value>][&delpos=<value>][&return=<return page>]
```

PARAMETER	VALUE	DESCRIPTION
addpos	<Text string less than 30 characters>	Add one preset location to the preset list.
channel	<0~(n-1)>	Channel of the video source.
delpos	<Text string less than 30 characters>	Delete preset location from preset list.
return	<return page>	Redirect to the page <return page> after the parameter is assigned. The <return page> can be a full URL path or relative

	path according to the current path. If you omit this parameter, it will redirect to an empty page.
--	--

8.14 ePTZ Preset Locations (**capability.eptz > 0**)

Note: This request requires Operator privileges.

Method: GET/POST

Syntax:

```
http://<servername>/cgi-bin/operator/ePreset.cgi?channel=<value>&stream=<value>
[&addpos=<value>][&delpos=<value>][&return=<return page>]
```

PARAMETER	VALUE	DESCRIPTION
channel	<0~(n-1)>	Channel of the video source.
stream	<0~(m-1)>	Stream.
addpos	<Text string less than 40 characters>	Add one preset location to the preset list.
delpos	<Text string less than 40 characters>	Delete preset location from the preset list.
return	<return page>	Redirect to the page <return page> after the parameter is assigned. The <return page> can be a full URL path or relative path according to the current path.

8.15 IP Filtering

Note: This request requires Administrator access privileges.

Method: GET/POST

Syntax: <product dependent>

```
http://<servername>/cgi-bin/admin/ipfilter.cgi?type[=<value>]
```

```
http://<servername>/cgi-bin/admin/ipfilter.cgi?method=add<v4/v6>&ip=<ipaddress>[&index=<value>]
[&return=<return page>]
```

```
http://<servername>/cgi-bin/admin/ipfilter.cgi?method=del<v4/v6>&index=<value>[&return=<return
page>]
```

PARAMETER	VALUE	DESCRIPTION
type	NULL	Get IP filter type
	allow, deny	Set IP filter type
method	addv4	Add IPv4 address into access list.
	addv6	Add IPv6 address into access list.
	delv4	Delete IPv4 address from access list.
	delv6	Delete IPv6 address from access list.
ip	<IP address>	Single address: <IP address> Network address: <IP address / network mask> Range address: <start IP address - end IP address>
index	<value>	The start position to add or to delete.
return	<return page>	Redirect to the page <return page> after the parameter is assigned. The <return page> can be a full URL path or relative path according to the current path. If you omit this parameter, it will redirect to an empty page.

8.16 UART HTTP Tunnel Channel (**capability.nuart > 0**)

Note: This request requires Operator privileges.

Method: GET and POST

Syntax:

```
http://<servername>/cgi-bin/operator/uartchannel.cgi?[channel=<value>]
```

```
-----
```

```
GET /cgi-bin/operator/uartchannel.cgi?[channel=<value>]
```

```
x-sessioncookie: string[22]
```

```
accept: application/x-vvtk-tunnelled
```

```
pragma: no-cache
```

```
cache-control: no-cache
```

```
-----
```

```
POST /cgi-bin/operator/uartchannel.cgi
```

```
x-sessioncookie: string[22]
```

```
content-type: application/x-vvtk-tunnelled
```

```
pragma : no-cache
```

```
cache-control : no-cache
```

```
content-length: 32767
```

```
expires: Sun, 9 Jan 1972 00:00:00 GMT
```

User must use GET and POST to establish two channels for downstream and upstream. The x-sessioncookie in GET and POST should be the same to be recognized as a pair for one session. The contents of upstream should be base64 encoded to be able to pass through a proxy server.

This channel will help to transfer the raw data of UART over the network.

Please see UART tunnel spec for detail information

PARAMETER	VALUE	DESCRIPTION
channel	0 ~ (n-1)	The channel number of UART.

8.17 Event/Control HTTP Tunnel Channel (**capability.**

evctrlchannel > 0)

Note: This request requires **Administrator** privileges.

Method: GET and POST

Syntax:

```
http://<servername>/cgi-bin/admin/ctrlevent.cgi
```

```
-----
```

```
GET /cgi-bin/admin/ctrlevent.cgi
```

```
x-sessioncookie: string[22]
```

```
accept: application/x-vvtk-tunnelled
```

```
pragma: no-cache
```

```
cache-control: no-cache
```

```
-----
```

```
POST /cgi-bin/admin/ ctrlevent.cgi
```

```
x-sessioncookie: string[22]
```

```
content-type: application/x-vvtk-tunnelled
```

```
pragma : no-cache
```

```
cache-control : no-cache
```

```
content-length: 32767
```

```
expires: Sun, 9 Jan 1972 00:00:00 GMT
```

User must use GET and POST to establish two channels for downstream and upstream. The x-sessioncookie in GET and POST should be the same to be recognized as a pair for one session. The contents of upstream should be base64 encoded to be able to pass through the proxy server.

This channel will help perform real-time event subscription and notification as well as camera control more efficiently. The event and control formats are described in another document.

See Event/control tunnel spec for detail information

8.18 Get SDP of Streams

Note: This request requires Viewer access privileges.

Method: GET/POST

Syntax:

```
http://<servername>/<network_rtsp_s<0~m-1>_accessname>
```

"m" is the stream number.

"network_accessname_<0~(m-1)>" is the accessname for stream "1" to stream "m". Please refer to the "subgroup of network: rtsp" for setting the accessname of SDP.

You can get the SDP by HTTP GET.

When using scalable multicast, Get SDP file which contains the multicast information via HTTP.

8.19 Open the Network Stream

Note: This request requires Viewer access privileges.

Syntax:

For HTTP push server (MJPEG):

```
http://<servername>/<network_http_s<0~m-1>_accessname>
```

For RTSP (MP4), the user needs to input the URL below into an RTSP compatible player.

```
rtsp://<servername>/<network_rtsp_s<0~m-1>_accessname>
```

"m" is the stream number.

For details on streaming protocol, please refer to the "control signaling" and "data format" documents.

8.20 Senddata (capability.nuart > 0)

Note: This request requires Viewer privileges.

Method: GET/POST

Syntax:

```
http://<servername>/cgi-bin/viewer/senddata.cgi?
[com=<value>][&data=<value>][&flush=<value>] [&wait=<value>] [&read=<value>]
```

PARAMETER	VALUE	DESCRIPTION
com	1 ~ <max. com port number>	The target COM/RS485 port number.
data	<hex decimal data>[,<hex decimal data>]	The <hex decimal data> is a series of digits from 0 ~ 9, A ~ F. Each comma separates the commands by 200 milliseconds.
flush	yes,no	yes: Receive data buffer of the COM port will be cleared before read. no: Do not clear the receive data buffer.
wait	1 ~ 65535	Wait time in milliseconds before read data.
read	1 ~ 128	The data length in bytes to read. The read data will be in the return page.

Return:

```
HTTP/1.0 200 OK\r\n
Content-Type: text/plain\r\n
Content-Length: <system information length>\r\n
\r\n
<hex decimal data>\r\n
```

Where hexadecimal data is digits from 0 ~ 9, A ~ F.

8.21 Storage managements (capability.storage.dbenabled > 0)

Note: This request requires **administrator** privileges.

Method: GET and POST

Syntax:

```
http://<servername>/cgi-bin/admin/lctrl.cgi?cmd=<cmd_type>[&<parameter>=<value>...]
```

The commands usage and their input arguments are as follows.

PARAMETER	VALUE	DESCRIPTION
cmd_type	<string>	Required. Command to be executed, including <i>search</i> , <i>insert</i> , <i>delete</i> , <i>update</i> , and <i>queryStatus</i> .

Command: **search**

PARAMETER	VALUE	DESCRIPTION
label	<integer primary key>	Optional. The integer primary key column will automatically be assigned a unique integer.
triggerType	<text>	Optional. Indicate the event trigger type. Please embrace your input value with single quotes. Ex. mediaType='motion' Support trigger types are product dependent.
mediaType	<text>	Optional. Indicate the file media type. Please embrace your input value with single quotes. Ex. mediaType='videoclip' Support trigger types are product dependent.
destPath	<text>	Optional. Indicate the file location in camera. Please embrace your input value with single quotes. Ex. destPath = '/mnt/auto/CF/NCMF/abc.mp4'
resolution	<text>	Optional. Indicate the media file resolution. Please embrace your input value with single quotes. Ex. resolution='800x600'
isLocked	<boolean>	Optional.

		<p>Indicate if the file is locked or not.</p> <p>0: file is not locked.</p> <p>1: file is locked.</p> <p>A locked file would not be removed from UI or cyclic storage.</p>
triggerTime	<text>	<p>Optional.</p> <p>Indicate the event trigger time. (not the file created time)</p> <p>Format is "YYYY-MM-DD HH:MM:SS"</p> <p>Please embrace your input value with single quotes.</p> <p>Ex. triggerTime='2008-01-01 00:00:00'</p> <p>If you want to search for a time period, please apply "TO" operation.</p> <p>Ex. triggerTime='2008-01-01 00:00:00'+TO+'2008-01-01 23:59:59' is to search for records from the start of Jan 1st 2008 to the end of Jan 1st 2008.</p>
limit	<positive integer>	<p>Optional.</p> <p>Limit the maximum number of returned search records.</p>
offset	<positive integer>	<p>Optional.</p> <p>Specifies how many rows to skip at the beginning of the matched records.</p> <p>Note that the offset keyword is used after limit keyword.</p>

To increase the flexibility of search command, you may use "OR" connectors for logical "OR" search operations. Moreover, to search for a specific time period, you can use "TO" connector.

Ex. To search records triggered by motion or di or sequential and also triggered between 2008-01-01 00:00:00 and 2008-01-01 23:59:59.

```
http://<servername>/cgi-bin/admin/lctrl.cgi?cmd=search&triggerType='motion'+OR+'di'+OR+'seq'&triggerTime='2008-01-01 00:00:00'+TO+'2008-01-01 23:59:59'
```

Command: **delete**

PARAMETER	VALUE	DESCRIPTION
label	<integer primary key>	<p>Required.</p> <p>Identify the designated record.</p> <p>Ex. label=1</p>

Ex. Delete records whose key numbers are 1, 4, and 8.

```
http://<servername>/cgi-bin/admin/lctrl.cgi?cmd=delete&label=1&label=4&label=8
```

Command: **update**

PARAMETER	VALUE	DESCRIPTION
label	<integer primary key>	Required. Identify the designated record. Ex. label=1
isLocked	<boolean>	Required. Indicate if the file is locked or not.

Ex. Update records whose key numbers are 1 and 5 to be locked status.

```
http://<servername>/cgi-bin/admin/lctrl.cgi?cmd=update&isLocked=1&label=1&label=5
```

Ex. Update records whose key numbers are 2 and 3 to be unlocked status.

```
http://<servername>/cgi-bin/admin/lctrl.cgi?cmd=update&isLocked=0&label=2&label=3
```

Command: **queryStatus**

PARAMETER	VALUE	DESCRIPTION
retType	xml or javascript	Optional. Ex. retype=javascript The default return message is in XML format.

Ex. Query local storage status and call for javascript format return message.

```
http://<servername>/cgi-bin/admin/lctrl.cgi?cmd=queryStatus&retType=javascript
```

8.22 Virtual input (**capability.nvi > 0**)

Note: Change virtual input (manual trigger) status.

Method: GET

Syntax:

```
http://<servername>/cgi-bin/admin/setvi.cgi?vi0=<value>[&vi1=<value>][&vi2=<value>]
[&return=<return page>]
```

PARAMETER	VALUE	DESCRIPTION
vi<num>	state[(duration)nstate] Where "state" is 0, 1. "0" means inactive or normal state while "1" means active or triggered state. Where "nstate" is next state after duration.	Ex: vi0=1 Setting virtual input 0 to trigger state Ex: vi0=0(200)1 Setting virtual input 0 to normal state, waiting 200 milliseconds , setting it to trigger state. Note that when the virtual input is waiting for next state, it cannot accept new requests.
return	<return page>	Redirect to the page <return page> after the request is completely assigned. The <return page> can be a full URL path or relative path according the current path. If you omit this parameter, it will redirect to an empty page.

Return Code	Description
200	The request is successfully executed.
400	The request cannot be assigned, ex. incorrect parameters. Examples: setvi.cgi?vi0=0(10000)1(15000)0(20000)1 No multiple duration. setvi.cgi?vi3=0 VI index is out of range. setvi.cgi?vi=1 No VI index is specified.
503	The resource is unavailable, ex. Virtual input is waiting for next state. Examples: setvi.cgi?vi0=0(15000)1 setvi.cgi?vi0=1 Request 2 will not be accepted during the execution time(15 seconds).

8.23 Open Timeshift Stream (capability.timeshift > 0, timeshift_enable=1, timeshift_c<n>_s<m>_allow=1)

Note: This request requires Viewer access privileges.

Syntax:

For HTTP push server (MJPEG):

```
http://<servername>/<network_http_s<m>_accessname>?maxsft=<value>[&tsmode=<value>&reftime=<value>&forcechk&minsft=<value>]
```

For RTSP (MP4 and H264), the user needs to input the URL below into an RTSP compatible player.

```
rtsp://<servername>/<network_rtsp_s<m>_accessname>?maxsft=<value>[&tsmode=<value>&reftime=<value>&forcechk&minsft=<value>]
```

“n” is the channel index.

“m” is the timeshift stream index.

For details on timeshift stream, please refer to the “TimeshiftCaching” documents.

PARAMETER	VALUE	DEFAULT	DESCRIPTION
maxsft	<positive interger>	0	Request cached stream at most how many seconds ago.
tsmode	normal, adaptive	normal	Streaming mode: normal => Full FPS all the time. adaptive => Default send only I-frame for MP4 and H.264, and send 1 FPS for MJPEG. If DI or motion window are triggered, the streaming is changed to send full FPS for 10 seconds. (*Note: this parameter also works on non-timeshift streams.)
reftime	mm:ss	The time camera receives the request.	Reference time for maxsft and minsft. (This provides more precise time control to eliminate the inaccuracy due to network latency.) Ex: Request the streaming from 12:20 rtsp://10.0.0.1/live.sdp?maxsft=10&reftime=12:30
forcechk	N/A	N/A	Check if the requested stream enables timeshift, feature and if minsft is achievable. If false, return “415 Unsupported Media Type”.
minsft	<positive interger>	0	How many seconds of cached stream client can accept at

	integer>		least. (Used by forcechk)
--	----------	--	------------------------------

Return Code	Description
400 Bad Request	Request is rejected because some parameter values are illegal.
415 Unsupported Media Type	Returned, if forcechk appears, when minsft is not achievable or the timeshift feature of the target stream is not enabled.

8. 24 Open Anystream (capability.nanystream > 0)

Note: This request requires Viewer access privileges.

Syntax:

For HTTP push server (MJPEG):

```
http://<servername>/videoany.mjpg?codectype=mjpeg[&resolution=<value>&mjpeg_quant=<value>&mjpeg_qvalue=<value>&mjpeg_maxframe=<value>]
```

For RTSP (MPEG4), the user needs to input the URL below into an RTSP compatible player.

```
rtsp://<servername>/liveany.sdp?codectype=mpeg4[&resolution=<value>&mpeg4_intraperiod=<value>&mpeg4_ratecontrolmode=<value>&mpeg4_quant=<value>&mpeg4_qvalue=<value>&mpeg4_bitrate=<value>&mpeg4_maxframe=<value>]
```

For RTSP (H264), the user needs to input the URL below into an RTSP compatible player.

```
rtsp://<servername>/liveany.sdp?codectype=h264[&resolution=<value>&h264_intraperiod=<value>&h264_ratecontrolmode=<value>& h264_quant=<value>& h264_qvalue=<value>&h264_bitrate=<value>& h264_maxframe=<value>]
```

<product dependent>

PARAMETER	VALUE	DEFAULT	DESCRIPTION
codectype	mjpeg, mpeg4, h264 <product dependent>	N/A	Set codec type for Anystream.
solution	capability_videoin_resolution <product dependent>	<product dependent>	Video resolution in pixels.
mjpeg_quant	0, 1~5 99, 1~5 <product dependent>	3	Quality of JPEG video. 0,99 is the customized manual input setting. 1 = worst quality, 5 = best quality. <product dependent>
mjpeg_qvalue	10~200	50	Manual video quality level input.

	2~97 <product dependent>	<product dependent>	(This must be present if mjpeg_quant is equal to 0, 99) <product dependent>
mjpeg_maxframe	1~25, 26~30 (only for NTSC or 60Hz CMOS)	15	Set maximum frame rate in fps (for JPEG).
mpeg4_intraperiod	250, 500, 1000, 2000, 3000, 4000	1000	Intra frame period in milliseconds.
mpeg4_ratecontrolmode	cbr, vbr	vbr	cbr: constant bitrate vbr: fix quality
mpeg4_quant	0, 1~5 99, 1~5 <product dependent>	3	Quality of video when choosing vbr in "mpeg4_ratecontrolmode". 0,99 is the customized manual input setting. 1 = worst quality, 5 = best quality. <product dependent>
mpeg4_qvalue	1~31 2~31 <product dependent>	7 <product dependent>	Manual video quality level input. (This must be present if mpeg4_quant is equal to 0, 99) <product dependent> <product dependent>
mpeg4_bitrate	1000~8000000 1000~4000000 <product dependent>	512000 <product dependent>	Set bit rate in bps when choosing cbr in "mpeg4_ratecontrolmode".
mpeg4_maxframe	1~25, 26~30 (only for NTSC or 60Hz CMOS)	10 15 <product dependent>	Set maximum frame rate in fps (for MPEG-4).
h264_intraperiod	250, 500, 1000, 2000, 3000, 4000	1000	Intra frame period in milliseconds.
h264_ratecontrolmode	cbr, vbr	vbr	cbr: constant bitrate vbr: fix quality
h264_quant	0, 1~5 99, 1~5 <product dependent>	3	Quality of video when choosing vbr in "h264_ratecontrolmode". 0,99 is the customized manual input setting. 1 = worst quality, 5 = best quality. <product dependent>
h264_qvalue	0~51 <product dependent>	30 <product dependent>	Manual video quality level input. (This must be present if h264_quant is

		dependent>	equal to 0, 99) <product dependent>
h264_bitrate	1000~8000000 1000~4000000 <product dependent>	512000 <product dependent>	Set bit rate in bps when choosing cbr in "h264_ratecontrolmode".
h264_maxframe	1~25, 26~30 (only for NTSC or 60Hz CMOS)	10 15 <product dependent>	Set maximum frame rate in fps (for H264).

Technical Specifications

Specifications

Ver. 1.0

Models	<ul style="list-style-type: none"> SD8311E/12E/13E (NTSC) SD8321E/22E/23E (PAL)
System	<ul style="list-style-type: none"> CPU: TI DM368 SoC Flash: 128MB RAM: 256MB Embedded OS: Linux 2.6
Pan/Tilt/Zoom	<ul style="list-style-type: none"> Pan range: 360° continuous rotation Tilt range: 0° ~ 90° flip 18x optical zoom (SD83x1E) 28x optical zoom (SD83x2E) 36x optical zoom (SD83x3E) Pan speed: 0.1° ~ 300° /sec Tilt speed: 0.1° ~ 120° /sec Auto pan mode Auto patrol mode
Lens	<ul style="list-style-type: none"> 18x optical zoom lens, f = 4.1 ~ 73.8 mm, F1.4 (wide), F3.0 (tele), auto focus, auto-iris, focus range: 10 mm (wide) ~ 800 mm (tele) to infinity (SD83x1E) 28x optical zoom lens, f = 3.5 ~ 98 mm, F1.35 (wide), F3.7 (tele), auto focus, auto-iris, focus range: 10 mm (wide) ~ 1500 mm (tele) to infinity (SD83x2E) 36x optical zoom lens, f = 3.4 ~ 122.4 mm, F1.6 (wide), F4.5 (tele), auto focus, auto-iris, focus range: 10 mm (wide) ~ 1500 mm (tele) to infinity (SD83x3E) Removable IR-cut filter for day & night function
Angle of View	<ul style="list-style-type: none"> 2.8 ~ 48° (horizontal) (SD83x1E) 2.1 ~ 55.8° (horizontal) (SD83x2E) 1.7 ~ 57.8° (horizontal) (SD83x3E)
Shutter Time	<ul style="list-style-type: none"> 1/1 sec. to 1/10,000 sec.
Image Sensor	<ul style="list-style-type: none"> 1/4" SONY EXview HAD CCD Sensor
Minimum Illumination	<ul style="list-style-type: none"> SD83x1E 0.01 Lux @F1.4 (Color); 0.001 Lux @F1.4 (B/W) SD83x2E 0.01 Lux @F1.35 (Color); 0.001 Lux @F1.35 (B/W) SD83x3E 0.01 Lux @F1.6 (Color); 0.001 Lux @F1.6 (B/W)
Video	<ul style="list-style-type: none"> Compression: H.264, MJPEG & MPEG-4 Streaming: <ul style="list-style-type: none"> Multiple simultaneous streams H.264 streaming over UDP, TCP, HTTP or HTTPS MPEG-4 streaming over UDP, TCP, HTTP or HTTPS MJPEG-4 multicast streaming MJPEG streaming over HTTP or HTTPS Supports activity adaptive streaming for dynamic frame rate control Supports 3GPP mobile surveillance Frame Rates: <ul style="list-style-type: none"> H.264: <ul style="list-style-type: none"> Up to 60/50 fps at 720x480 (SD8311E/12E/13E) /720x576 (SD8321E/22E/23E) MPEG-4: <ul style="list-style-type: none"> Up to 60/50 fps at 720x480 (SD8311E/12E/13E) /720x576 (SD8321E/22E/23E) MJPEG: <ul style="list-style-type: none"> Up to 60/50 fps at 720x480 (SD8311E/12E/13E) /720x576 (SD8321E/22E/23E) (Up to 30/25 fps in WDR mode)
Image Settings	<ul style="list-style-type: none"> Adjustable image size, quality and bit rate Time stamp and text caption overlay Flip & mirror Configurable brightness, contrast, saturation, sharpness, white balance and exposure AGC, AWB, AES WDR Pro EIS (Electronic Image Stabilization) (SD83x2E/x3E) Automatic, manual or scheduled day/night mode BLC (Backlight Compensation) Supports privacy masks
Audio	<ul style="list-style-type: none"> Compression: <ul style="list-style-type: none"> GSM-AMR speech encoding, bit rate: 4.75 kbps to 12.2 kbps MPEG-4 AAC audio encoding, bit rate: 16 kbps to 128 kbps G.711 audio encoding, bit rate: 64 kbps, μ-Law or A-Law mode selectable Interface: <ul style="list-style-type: none"> External microphone input Audio output Supports two-way audio Supports audio mute

Networking	<ul style="list-style-type: none"> 10/100 Mbps Ethernet, RJ-45 Onvif support Protocols: IPv4, IPv6, TCP/IP, HTTP, HTTPS, UPnP, RTSP/RTP/RTCP, IGMP, SMTP, FTP, DHCP, NTP, DNS, DDNS, PPPoE, CoS, QoS, SNMP and 802.1X
Alarm and Event Management	<ul style="list-style-type: none"> Triple-window video motion detection Audio detection Three D/I and two D/O for external sensor and alarm Event notification using HTTP, SMTP or FTP Local recording of MP4 file
On-Board Storage	<ul style="list-style-type: none"> SD/SDHC card slot Stores snapshots and video clips
Security	<ul style="list-style-type: none"> Multi-level user access with password protection IP address filtering HTTPS encrypted data transmission 802.1X port-based authentication for network protection
Users	<ul style="list-style-type: none"> Live viewing for up to 10 clients
Dimension	<ul style="list-style-type: none"> Camera: \varnothing 200 mm x 270 mm Cable length: 1330 mm Cable diameter: \varnothing 15 mm; Max width: \varnothing 20 mm
Weight	<ul style="list-style-type: none"> Net: 4,500 g (TBD)
LED Indicator	<ul style="list-style-type: none"> System power and status indicator System activity and network link indicator
Power	<ul style="list-style-type: none"> 24V AC Power consumption: Max. 60 W 802.3at compliance PoE plus
Housing	<ul style="list-style-type: none"> Weather-proof IP66-rated housing
Approvals	<ul style="list-style-type: none"> CE, LVD, FCC, VCCI, C-Tick
Operating Environments	<ul style="list-style-type: none"> Temperature: -40 ~ 55°C (AC 24V) Temperature: -10 ~ 55°C (PoE Plus) Humidity: 90% RH
Viewing System Requirements	<ul style="list-style-type: none"> OS: Microsoft Windows 7/Vista/XP/2000 Browser: Mozilla Firefox, Internet Explorer 6.x or above Cell phone: 3GPP player Real Player: 10.5 or above Quick Time: 6.5 or above
Installation, Management, and Maintenance	<ul style="list-style-type: none"> Installation Wizard 2 32-CH ST7501 recording software Supports firmware upgrade
Applications	<ul style="list-style-type: none"> SDK available for application development and system integration
Warranty	<ul style="list-style-type: none"> 24 months

Dimension

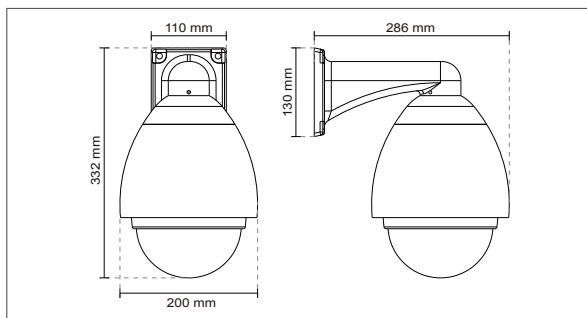

All specifications are subject to change without notice. Copyright©2011 VIVOTEK INC. All rights reserved. P/N: 971004400

Distributed by:



VIVOTEK INC.

6F, No.192, Lien-Cheng Rd., Chung-Ho, New Taipei City, 235, Taiwan, R.O.C.
 [T: +886-2-82455282 | F: +886-2-82455532 | E: sales@vivotek.com

VIVOTEK USA, INC.

470 Lakeside Drive Suite C, Sunnyvale, CA 94085 USA

Technology License Notice

MPEG-4 AAC Technology

THIS PRODUCT IS LICENSED UNDER THE MPEG-4 AAC AUDIO PATENT LICENSE. THIS PRODUCT MAY NOT BE DECOMPILED, REVERSE-ENGINEERED OR COPIED, EXCEPT WITH REGARD TO PC SOFTWARE, OF WHICH YOU MAY MAKE SINGLE COPIES FOR ARCHIVAL PURPOSES. FOR MORE INFORMATION, PLEASE REFER TO [HTTP://WWW.VIALICENSING.COM](http://www.vialicensing.com).

MPEG-4 Visual Technology

THIS PRODUCT IS LICENSED UNDER THE MPEG-4 VISUAL PATENT PORTFOLIO LICENSE FOR THE PERSONAL AND NON-COMMERCIAL USE OF A CONSUMER FOR (i) ENCODING VIDEO IN COMPLIANCE WITH THE MPEG-4 VISUAL STANDARD ("MPEG-4 VIDEO") AND/OR (ii) DECODING MPEG-4 VIDEO THAT WAS ENCODED BY A CONSUMER ENGAGED IN A PERSONAL AND NON-COMMERCIAL ACTIVITY AND/OR WAS OBTAINED FROM A VIDEO PROVIDER LICENSED BY MPEG LA TO PROVIDE MPEG-4 VIDEO. NO LICENSE IS GRANTED OR SHALL BE IMPLIED FOR ANY OTHER USE. ADDITIONAL INFORMATION INCLUDING THAT RELATING TO PROMOTIONAL, INTERNAL AND COMMERCIAL USES AND LICENSING MAY BE OBTAINED FROM MPEG LA, LLC. PLEASE REFER TO [HTTP://WWW.MPEGLA.COM](http://www.mpeg-la.com).

AMR-NB Standard

THIS PRODUCT IS LICENSED UNDER THE AMR-NB STANDARD PATENT LICENSE AGREEMENT. WITH RESPECT TO THE USE OF THIS PRODUCT, THE FOLLOWING LICENSORS' PATENTS MAY APPLY:

TELEFONAKIEBOLAGET ERICSSON AB: US PAT. 6192335; 6275798; 6029125; 6424938; 6058359. NOKIA CORPORATION: US PAT. 5946651; 6199035. VOICEAGE CORPORATION: AT PAT. 0516621; BE PAT. 0516621; CA PAT. 2010830; CH PAT. 0516621; DE PAT. 0516621; DK PAT. 0516621; ES PAT. 0516621; FR PAT. 0516621; GB PAT. 0516621; GR PAT. 0516621; IT PAT. 0516621; LI PAT. 0516621; LU PAT. 0516621; NL PAT. 0516621; SE PAT. 0516621; US PAT. 5444816; AT PAT. 819303/AT E 198805T1; AU PAT. 697256; BE PAT. 819303; BR PAT. 9604838-7; CA PAT. 2216315; CH PAT. 819303; CN PAT. ZL96193827.7; DE PAT. 819303/DE69611607T2; DK PAT. 819303; ES PAT. 819303; EP PAT. 819303; FR PAT. 819303; GB PAT. 819303; IT PAT. 819303; JP PAT. APP. 8-529817; NL PAT. 819303; SE PAT. 819303; US PAT. 5664053. THE LIST MAY BE UPDATED FROM TIME TO TIME BY LICENSORS AND A CURRENT VERSION OF WHICH IS AVAILABLE ON LICENSOR'S WEBSITE AT [HTTP://WWW.VOICEAGE.COM](http://www.voiceage.com).

Electromagnetic Compatibility (EMC)

FCC Statement

This device complies with FCC Rules Part 15. Operation is subject to the following two conditions.

- This device may not cause harmful interference, and
- This device must accept any interference received, including interference that may cause undesired operation.

This equipment has been tested and found to comply with the limits for a Class A digital device, pursuant to Part 15 of the FCC Rules. These limits are designed to provide reasonable protection against harmful interference when the equipment is operated in a commercial environment. This equipment generates, uses, and can radiate radio frequency energy and, if not installed and used in accordance with the installation manual, may cause harmful interference to radio communications. Operation of this equipment in a residential area is likely to cause harmful interference, in which case the user will be required to correct the interference at his own expense.

CE Mark Warning

This is a Class A product. In a domestic environment, this product may cause radio interference, in which case the user may be required to take adequate measures.

VCCI Warning

この装置は、情報処理装置等電波障害自主規制協議会（VCCI）の基準に基づくクラスB情報技術装置です。この装置は、家庭環境で使用することを目的としていますが、この装置がラジオやテレビジョン受信機に近接して使用されると、受信障害を引き起こすことがあります。

取扱説明書に従って正しい取り扱いをして下さい

Liability

VIVOTEK Inc. cannot be held responsible for any technical or typographical errors and reserves the right to make changes to the product and manuals without prior notice. VIVOTEK Inc. makes no warranty of any kind with regard to the material contained within this document, including, but not limited to, the implied warranties of merchantability and fitness for any particular purpose.