

# User's Manual

## NR8201/8301

H.264 • Compatible with VAST CMS • Lockable HDD & Rack Mount Design

### Network Video Recorder



### NR8201

*4-CH Viewing & Recording  
External eSATA Interface*



### NR8301

*8-CH Viewing & Recording  
Raid 0, 1 Scalable Storage*

## **Table of Contents**

---

<b>Overview</b> .....	<b>3</b>
Read before use.....	3
Package contents.....	3
Physical description.....	4
<b>Installation</b> .....	<b>8</b>
Hard Disk installation.....	8
Network deployment.....	9
<b>Home Page</b> .....	<b>17</b>
<b>Configuration</b> .....	<b>19</b>
Device.....	19
LAN.....	24
Access list.....	25
DDNS.....	26
Security.....	28
Schedule.....	30
Recording Policy.....	32
Trigger.....	35
Layout.....	38
System.....	39
Maintenance.....	42
Storage.....	43
Backup.....	44
System log.....	45
Joystick.....	46
<b>Monitor</b> .....	<b>47</b>
User Interface of Monitor Page.....	47
Functions of Monitor Page.....	49
<b>History</b> .....	<b>52</b>
User Interface of History Page.....	52
Functions of History Page.....	53
<b>Appendix</b> .....	<b>58</b>
Technical Specifications.....	58
URL Commands for the Network Camera.....	59

# Overview

VIVOTEK's NR8201/8301 network video recorder offers an elegant recording solution for VIVOTEK network cameras and performs real-time monitoring and recording simultaneously. It supports up to 4-CH (NR8201) and 8-CH (NR8301) H.264, MJPEG, and MPEG-4 video and provides multiple recording modes including alarm recording, scheduled recording, manual recording and continuous recording. The installation is very simple as the camera is able to be inserted automatically when it's plugged in. It also offers a user-friendly interface for the user to configure the network settings and the camera control. Moreover, the 802.3af compliant PoE (Power-over-Ethernet) is able to reduce the complex of the installation, making NR8201/8301 the cost-effective recording systems.

The user can utilize the NR8201/8301 to record high-definition mega-pixel videos on removable hard disk(s) with large capacity and a USB interface for data backup. The NR8201 also supports an external hard disk from the eSATA interface, and the NR8301 supports RAID 0 and 1 storage solution. The built-in gateway separates the network camera connection and the data network connection for the prevention of network congestion. Functional four digital inputs and one digital output interfaces is capable of integrating with the security sensors and alarms. The NR8201/8301 are comprehensive network video recorders featuring with multiple functions to provide the best quality and highest performance in network video recording.

## Read before use

The use of surveillance devices may be prohibited by law in your country. It is the user's responsibility to ensure that the operation of such devices is legal before installing this unit for its intended use.

It is important to first verify that all contents received are complete according to the Package contents listed below. Take notice of the warnings in Quick Installation Guide before the Network Video Recorder is installed; then carefully read and follow the instructions in the Installation chapter to avoid damages due to faulty assembly and installation. This also ensures the product is used properly as intended.

The Network Video Recorder is a network device and its use should be straightforward for those who have basic network knowledge. It is designed for various applications including audio/video recording, general security/surveillance, etc. The Configuration chapter suggests ways to best utilize the Network Video Recorder and ensure proper operations.

## Package contents

- NR8201/8301
- Rack mount kit
- Power cord
- Software CD
- Warranty card
- Quick installation guide

## Physical description

### Front panel

#### ■ NR8301

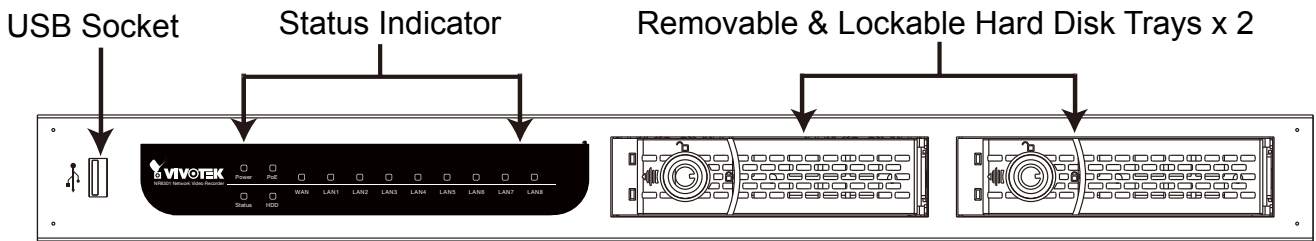

#### ■ NR8201

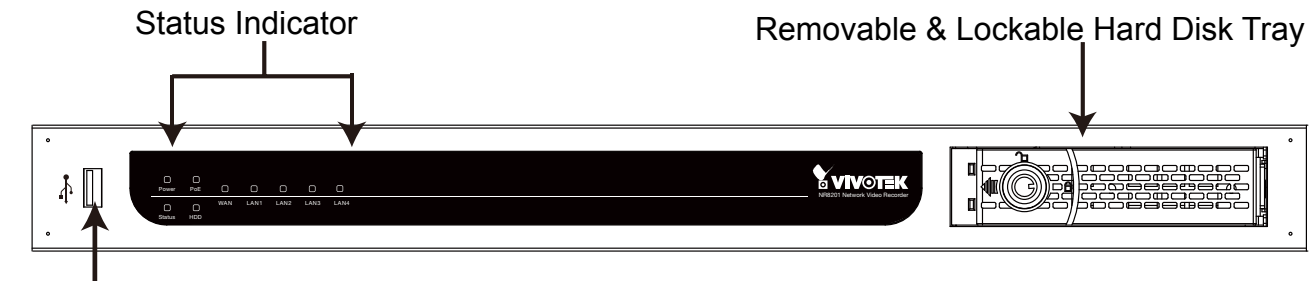

USB Socket

### Connectors

#### ■ NR8301

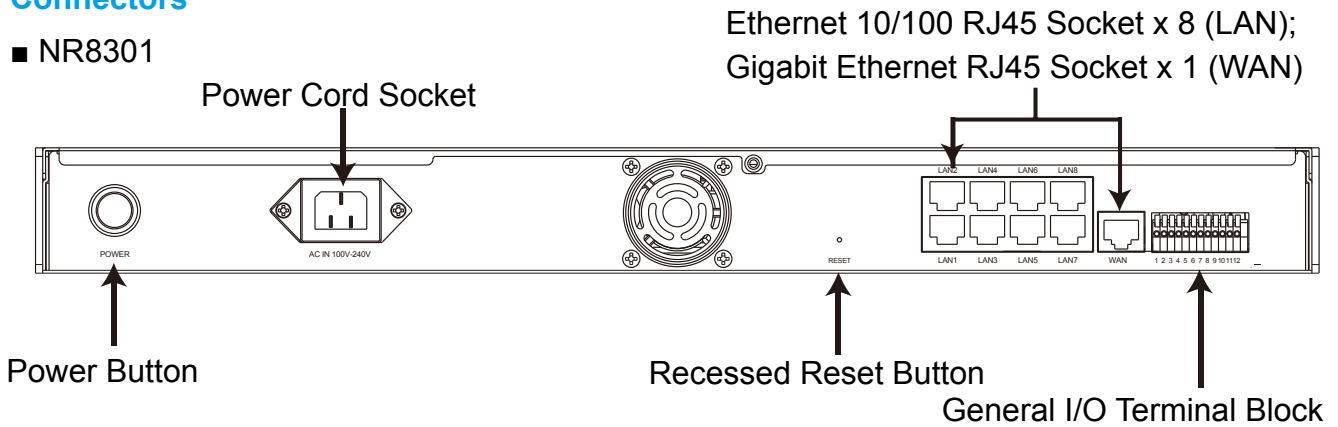

Ethernet 10/100 RJ45 Socket x 8 (LAN);  
Gigabit Ethernet RJ45 Socket x 1 (WAN)

#### ■ NR8201

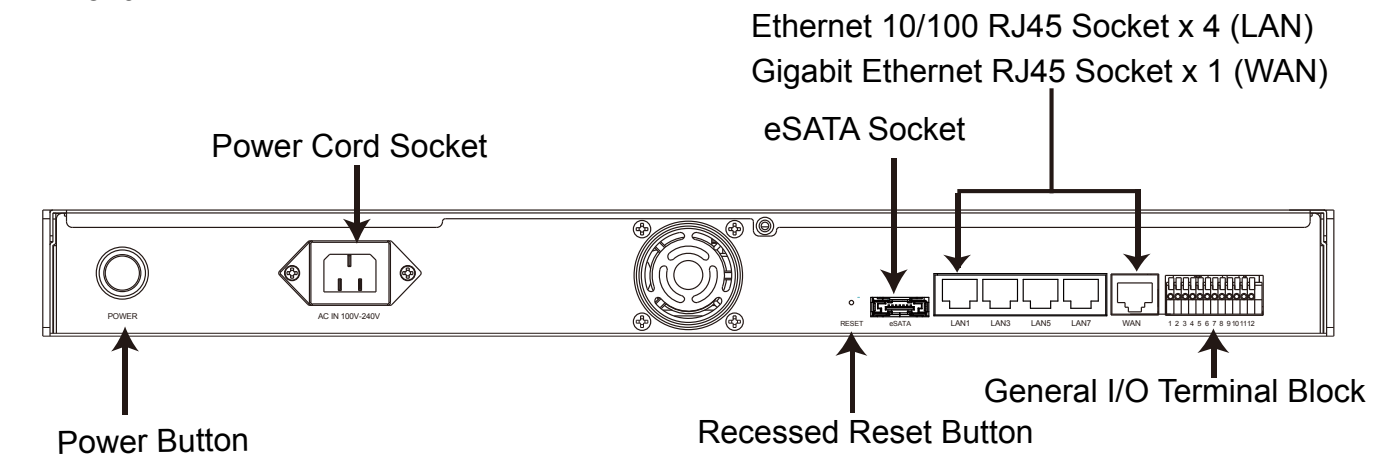

Ethernet 10/100 RJ45 Socket x 4 (LAN)  
Gigabit Ethernet RJ45 Socket x 1 (WAN)

## General I/O Terminal Block

This Network Camera provides a general I/O terminal block which is used to connect external input / output devices. The pin definitions are described below.

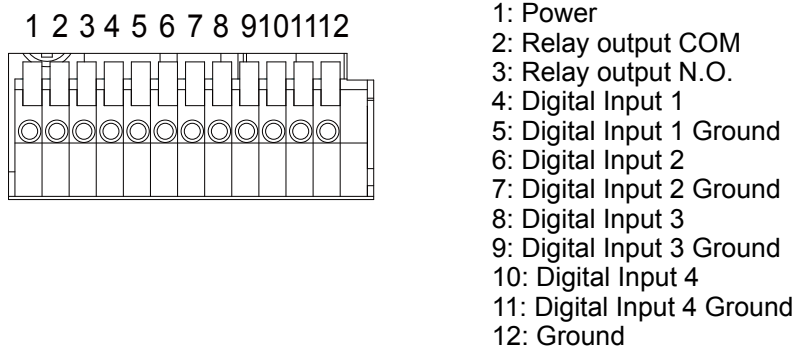

## DI/DO Diagram

Refer to the following illustration for connection method.

DI wiring diagram:

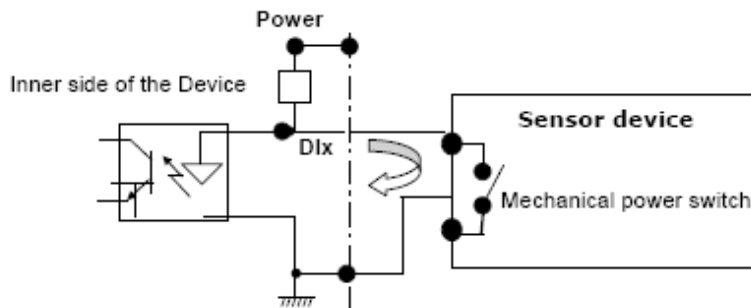

Relay wiring diagram 1

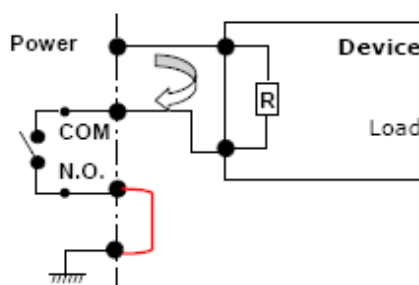

Relay wiring diagram 2

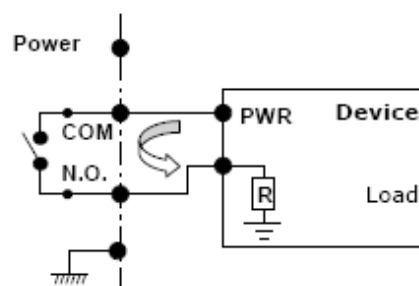

## Status LED

The LED indicates the status of the Network Video Recorder.

LED	Status	Indication
Power	On	Power on
	Off	Power off
POE	On	Power on
	Off	Power off
Status	Off	System not ready
	Green	System ready
	Blink Green	During system boot up and maintenance
	Orange	System failure
Hard disk	Blink Orange	System warning
	Off	No HDD attached
	Green HDD	normal (for 8301, either of the disks)
	Blink Green	Hard disk is recording or initializing (for 8301, either of the disks)
WAN	Blink Orange	HDD warning (for 8301, either of the disks)
	On	With connection on
	Off	No connection
	Blink	WAN port activated
LAN (1-8)	On	With connection
	Off	No connection
	Blink	LAN port activated (1-8)

## Hardware System Requirement

### Computer:

- Microsoft Windows XP Professional SP2 or above
- Internet Explorer 6.0 or later

### Hard disk:

- NR8201: Support 1 x 3.5" SATA I/II HDD, up to 2TB (Support external eSATA interface)
- NR8301: Support 2 x 3.5" SATA I/II HDD, up to 4TB (Support Raid0, 1 scalable storage)

## Hardware Reset

There is an indented reset button on the back panel of the Network Video Recorder. It is used to reboot the Network Video Recorder or restore the Network Video Recorder to factory default. Sometimes rebooting the Network Video Recorder could set it back to normal state. If the problems still remain after rebooted, restore the Network Video Recorder to factory default and install again.

**Reboot:** Press and release the indented reset button. All status LED will extinguish and then power on again. Wait for the Status LED to blink and then become steady green in normal state. It takes about 30 seconds to complete the procedure.

**Restore:** Press the reset button continuously for over 3 seconds. All status LED will extinguish and then power on again. Wait for the Status LED to blink and then become steady green in normal state. Note that all settings will be restored to factory default. It takes about 50 seconds to complete the procedure.

■ NR8301

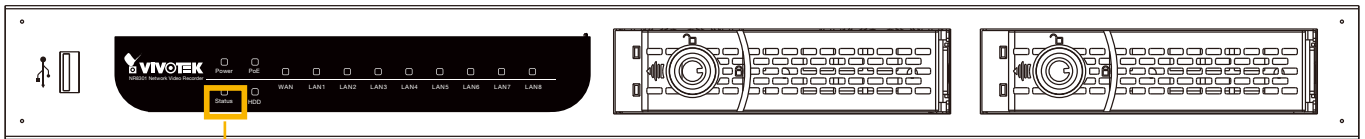

Steady green in normal state

■ NR8201

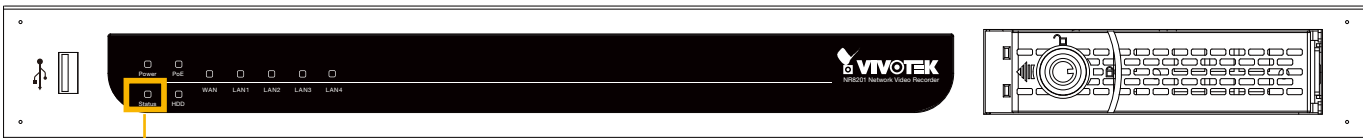

Steady green in normal state

# Installation

## Hard Disk installation

Before using the Network Video Recorder, please prepare **SATA hard disk(s)** for recording video.

1. Make sure the power is off.
2. Secure the supplied rack mount ears if you want to use rack mount installation.
3. Loose the lock of the hard disk as shown below and take out the bracket.
4. Put your hard disk into the bracket, and secure it with the supplied four screws.
5. Loose the lock of the hard disk as shown below and insert your hard disk(s) into the socket.
6. Use the supplied key to lock the hard disk socket(s) for security concern.

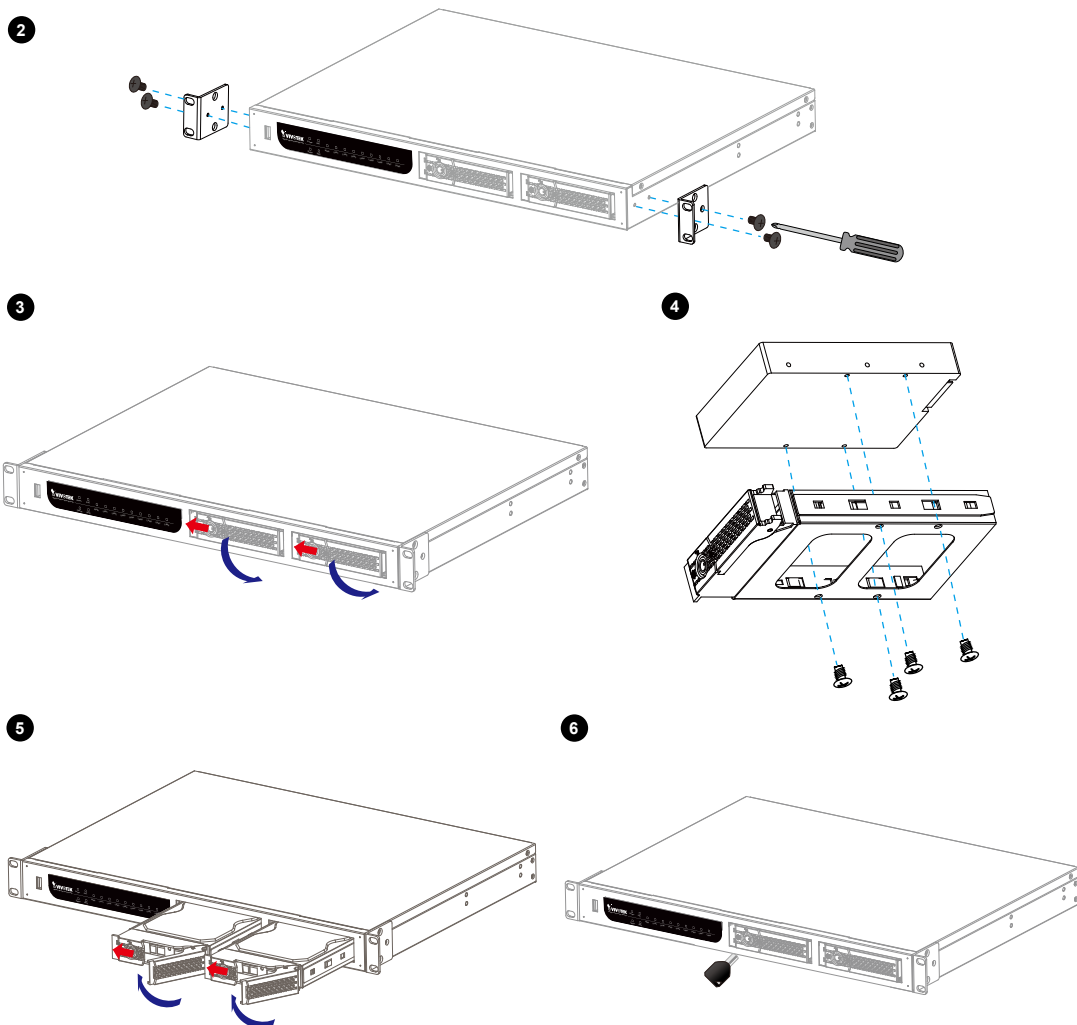

### **NOTE**

- ▶ Please remember to format the hard disk before starting recording. Please refer to **Storage** on page 43.



## Network deployment

### Device Connection

1. Connect the supplied power cable from the NR8201/8301 to a power outlet.
2. Press the power button.
3. Connect NR8201/8301 to Network Cameras and computer in LAN via LAN sockets.  
Because NR8201/8301 supports PoE, if the Network Camera is PoE-compliant (802.3af), it allows transmission of power and data via single Ethernet cable.
4. If you want to access NR8201/8301 over the Internet, connect NR8201/8301 to the Internet via WAN socket.
5. If you have external devices such as sensors and alarms, make connections from general I/O terminal block.

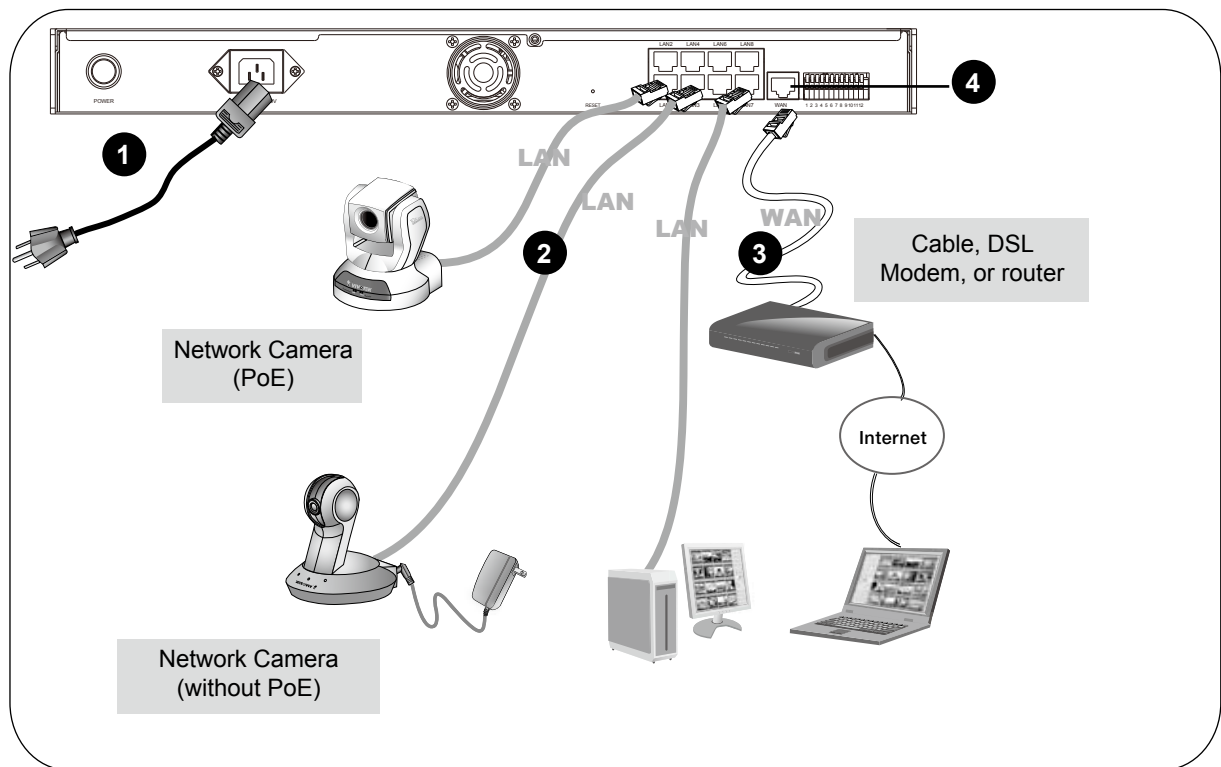

- 1: Power
- 2: Relay output COM
- 3: Relay output N.O.
- 4: Digital Input 1
- 5: Digital Input 1 Ground
- 6: Digital Input 2
- 7: Digital Input 2 Ground
- 8: Digital Input 3
- 9: Digital Input 3 Ground
- 10: Digital Input 4
- 11: Digital Input 4 Ground
- 12: Ground

## Getting Started

Please follow the steps below to link your computer to NR8201/8301 for the first time:

1. Connect your computer to NR8201/8301 (LAN port) using an Ethernet cable.
2. Setup your computer in DHCP mode.
  - a. Click **Start > My Network Places > View network connections**.
  - b. Right-click on **Local Area Connection**, and then click **Properties**.

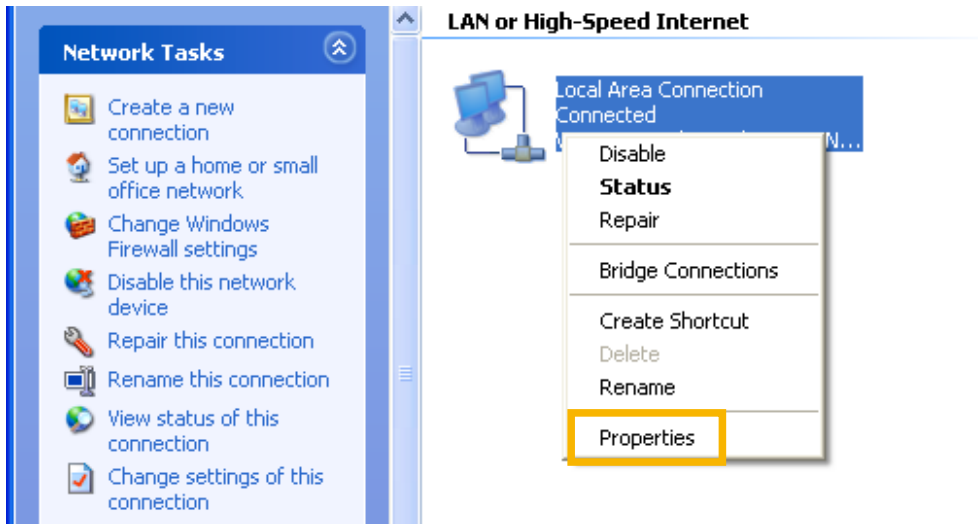

- c. Select **Internet Protocol (TCP/IP)**, and then click **Properties**.

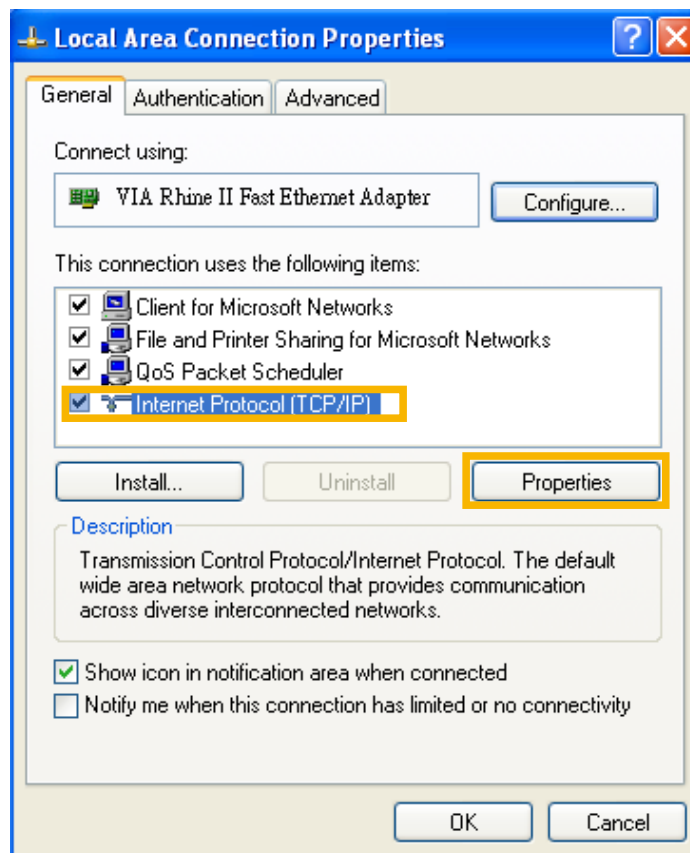

- d. Select "Obtain an IP address automatically" and "Obtain DNS server address automatically" as below. Then click **OK** to enable your settings.

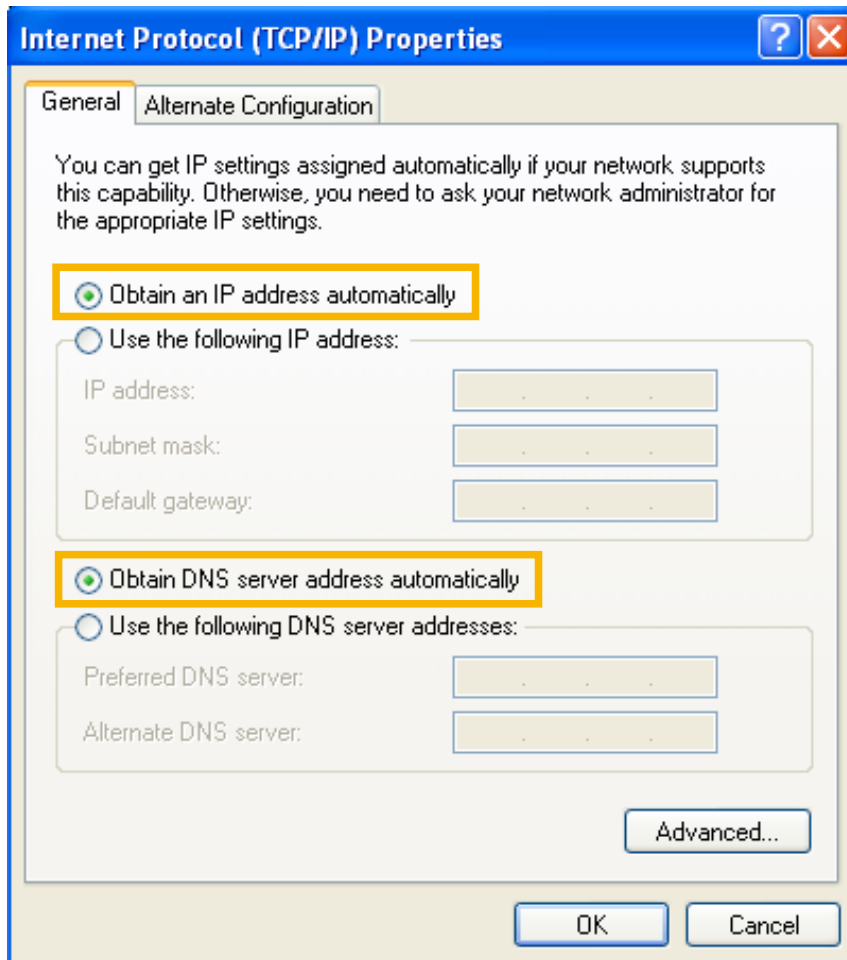

3. Then NR8201/8301 will serve as a router and automatically assign an IP address to your computer.

## Setup NR8201/8301 in LAN

To setup NR8201/8301 for the first time, please refer to page 10 to setup your computer in DHCP mode, and then directly enter the default IP address for NR8201/8301 (<http://192.168.100.1>) in the address bar of the web browser. The webpage of the Network Video Recorder will be displayed for you to configure the settings.

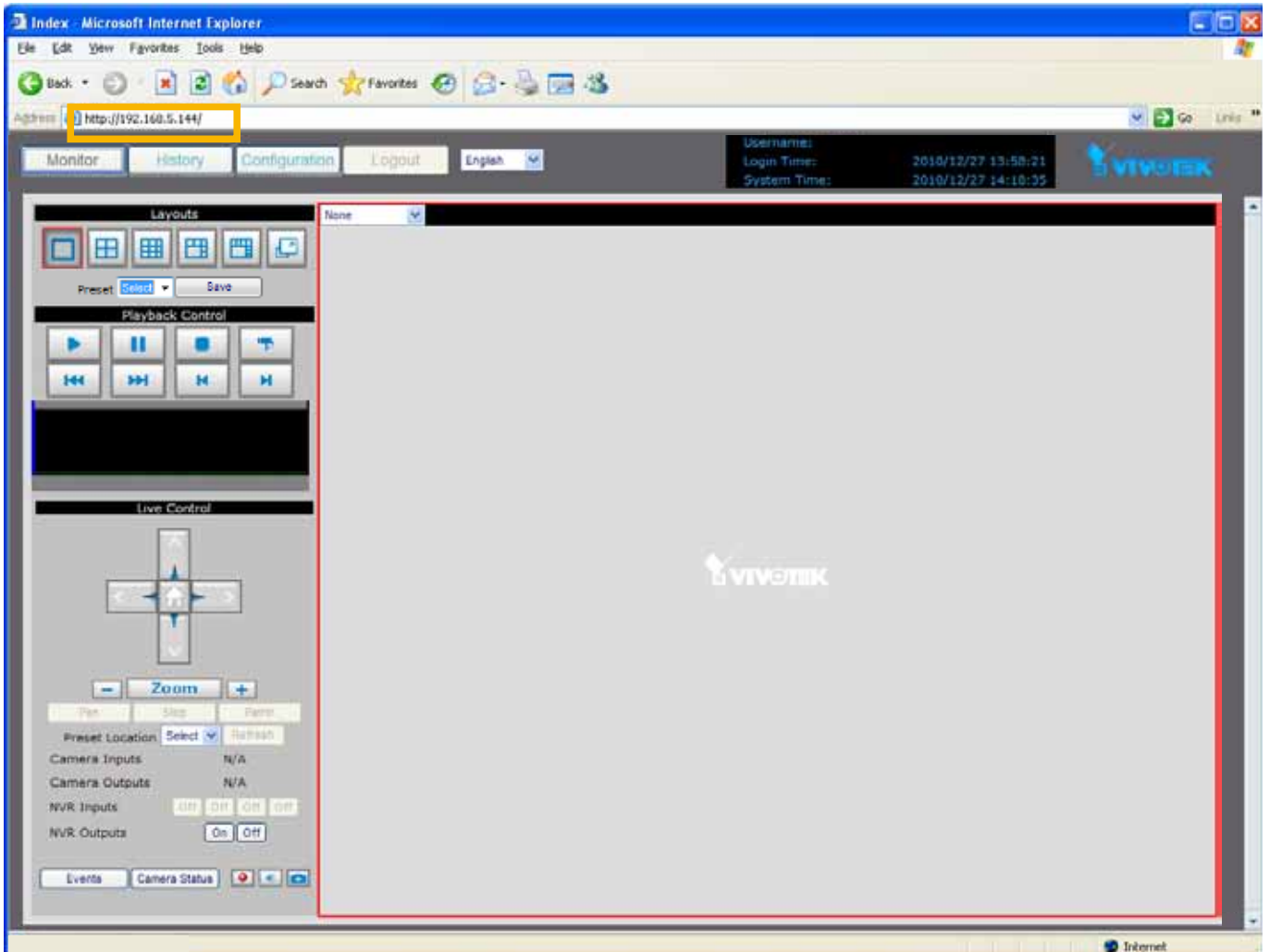

## LAN Settings Configuration

Go to **Configuration** > **LAN** to verify the settings as below.

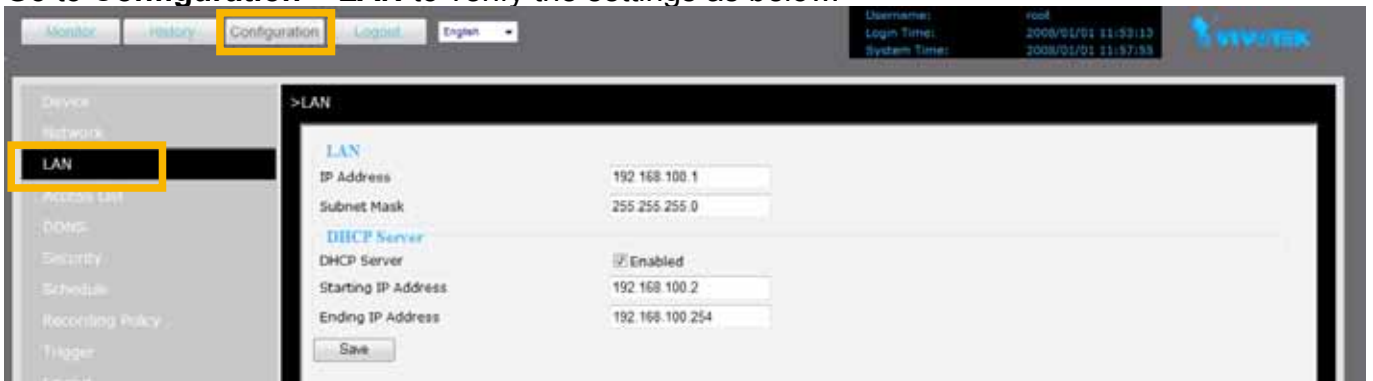

## Network Settings Configuration

If you want to access the Network Video Recorder over the Internet, please go to **Configuration > Network** to assign a WAN IP address (public IP) for NR8201/8301. There are three ways to get an IP address: **Private DHCP (Dynamic IP)**, **Static IP address**, and **PPPoE (DSL)**.

### Internet connection with private DHCP (dynamic IP)

Choose this connection type to automatically obtain a dynamic IP address assigned by a DHCP server. Please follow the steps below to verify the settings:

1. Go to **Configuration > Network**. Click **Get IP address automatically**.
2. Click **Save** to enable the settings.



3. If your computer is in the same domain with the WAN IP address, then you can use VIVOTEK Installation Wizard 2 (IW2) to search for the Network Video Recorder easily. Please follow the steps below to run IW2:

- a. Install the IW2 under the Software Utility directory from the software CD. Double-click the IW2 shortcut on your desktop to launch the program.
- b. The program will conduct analysis on your network environment. After your network environment is analyzed, please click Next to continue the program.

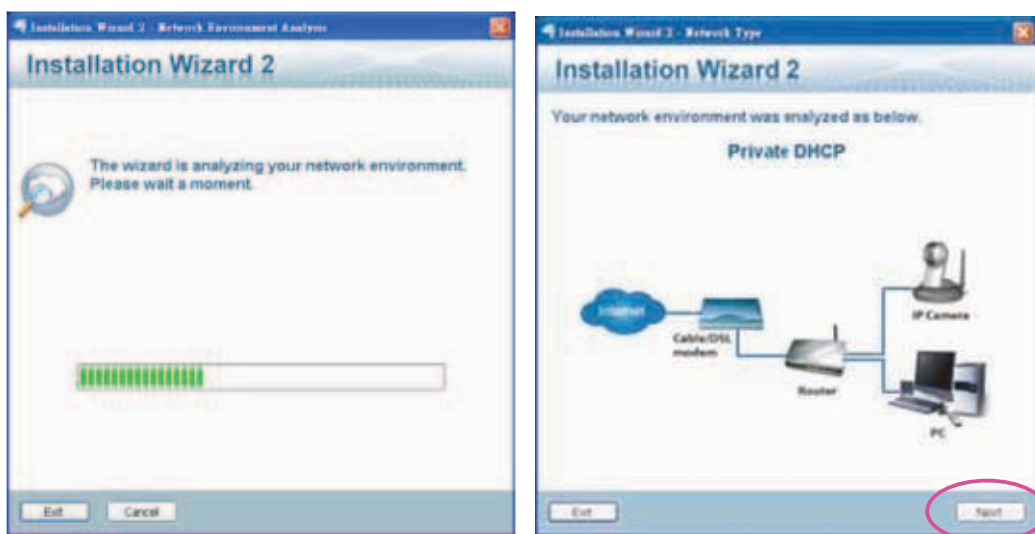

- c. The program will start searching for all VIVOTEK devices in the same LAN.

d. After searching, the main installer window will pop up. Click on the MAC and model name which match the product label on your device to connect to the Network Video Recorder.



### Internet connection with static IP

Choose this connection type if you want to use a static IP for the Network Video Recorder. Please follow the steps below to change the settings:

1. Go to **Configuration > Network**. Click **Use fixed IP address**.
2. Enter the static IP, Subnet Mask, Default Router, Primary DNS Server, and Secondary DNS Server provided by your ISP.
3. Click **Save** to enable the settings.
4. The MAC address will be shown when selecting fixed IP address.

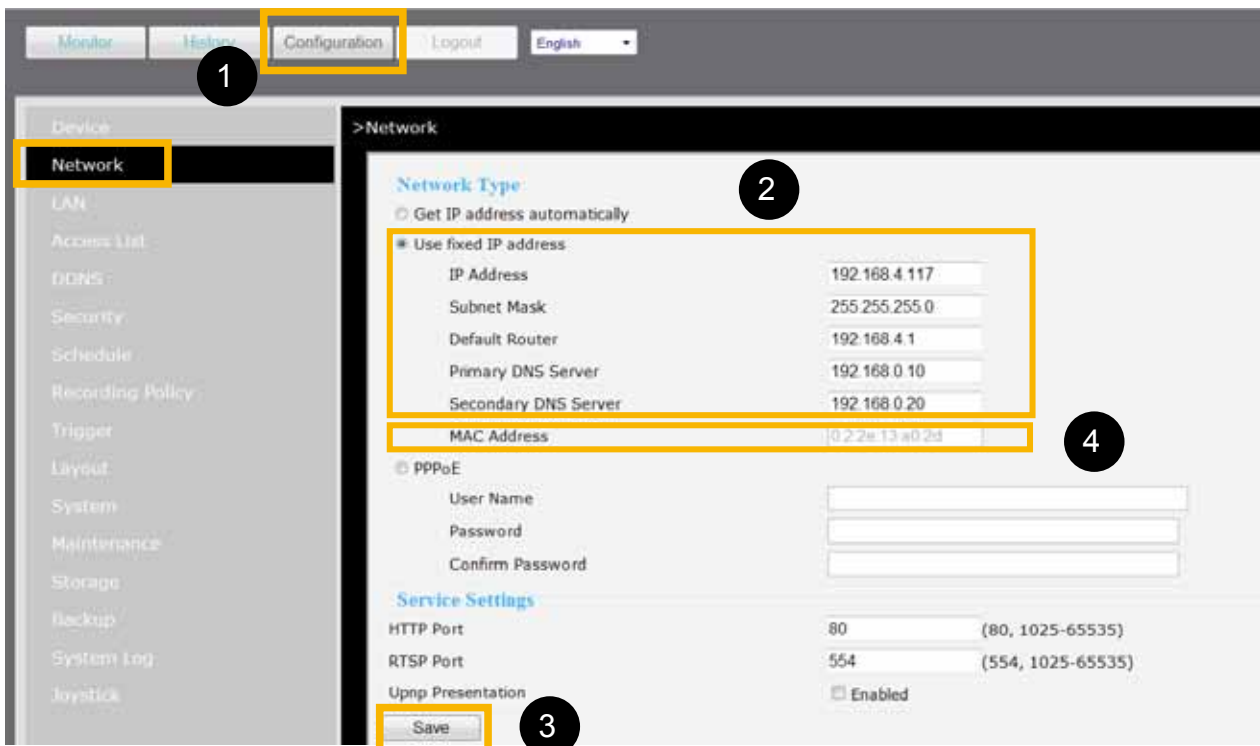

## Internet connection via PPPoE (Point-to-Point over Ethernet)

Choose this connection type if you wish to connect to the Internet via a DSL Line. Please follow the steps below to setup:

1. Go to **Configuration > Network**. Click **PPPoE**.
2. Enter the User Name and Password provided by your ISP.
3. Enable the Upnp protocol by selecting the Upnp presentation if you require to apply it.
4. Click **Save** to enable the settings.
5. The IP Address, Subnet Mask, Default Router, Primary DNS Server , MAC address will automatically show up in the above blanks.

The screenshot displays the 'Configuration > Network' page. The 'Configuration' tab is highlighted (1). The 'Network' menu item in the left sidebar is also highlighted (1). The 'Network Type' section has 'Use fixed IP address' selected (5). The fields for IP Address (192.168.4.117), Subnet Mask (255.255.255.0), Default Router (192.168.4.1), Primary DNS Server (192.168.0.10), Secondary DNS Server (192.168.0.20), and MAC Address (02:2e:13:a0:2d) are visible (5). The 'PPPoE' section is expanded, showing 'User Name' (VIVOTEK) and 'Password' (masked) fields (2). The 'Service Settings' section shows 'Upnp Presentation' set to 'Enabled' (3). The 'Save' button is highlighted (4).

**NOTE**

- ▶ When attempting link to NR8201/8301 for the first time with the web browser, a message will pop up to remind you of installing required plug-in or software first.

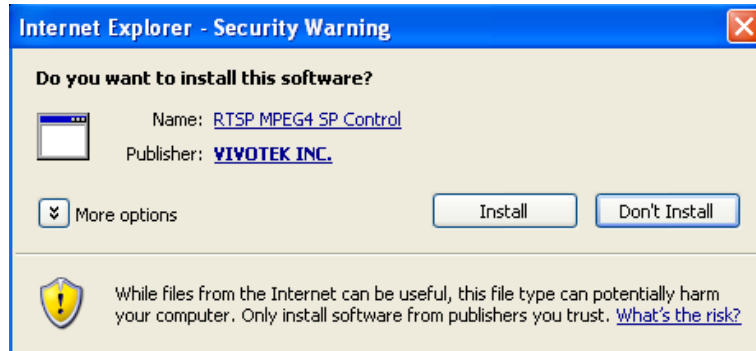

- ▶ If you receive a message saying that your Internet Explorer® security settings prohibit installing Active X® components, please enable your Active X® Controls for your browser.
  1. Click **Tools > Internet Options > Security > Custom level...** on the tool bar of the Internet browser.

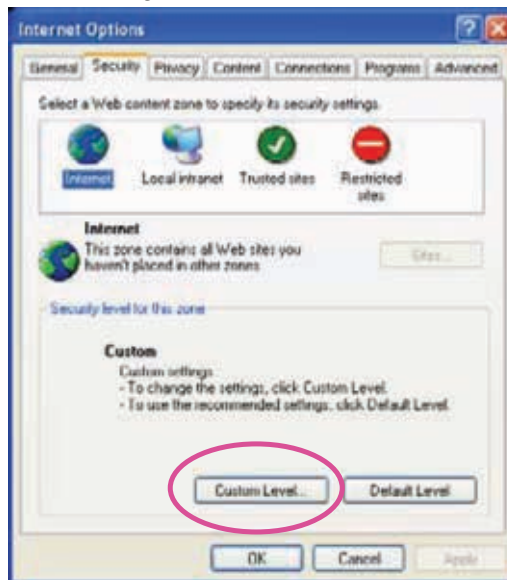

2. Look for Download signed ActiveX® controls; select Enable or Prompt. Click OK.

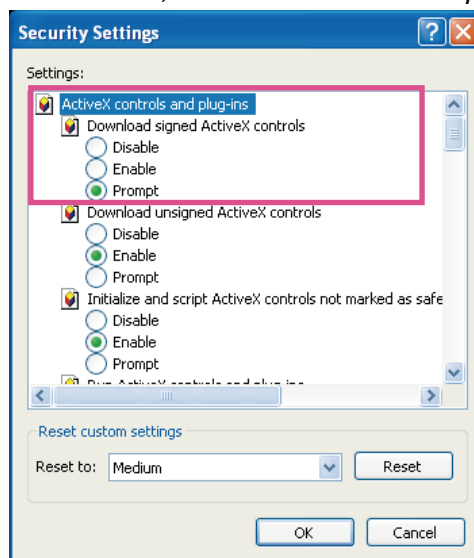

3. Refresh your web browser, and then install the Active X®. Follow the instructions to finish installation.



# Home Page

Following is the user interface of the home page. It is composed of the following sections.

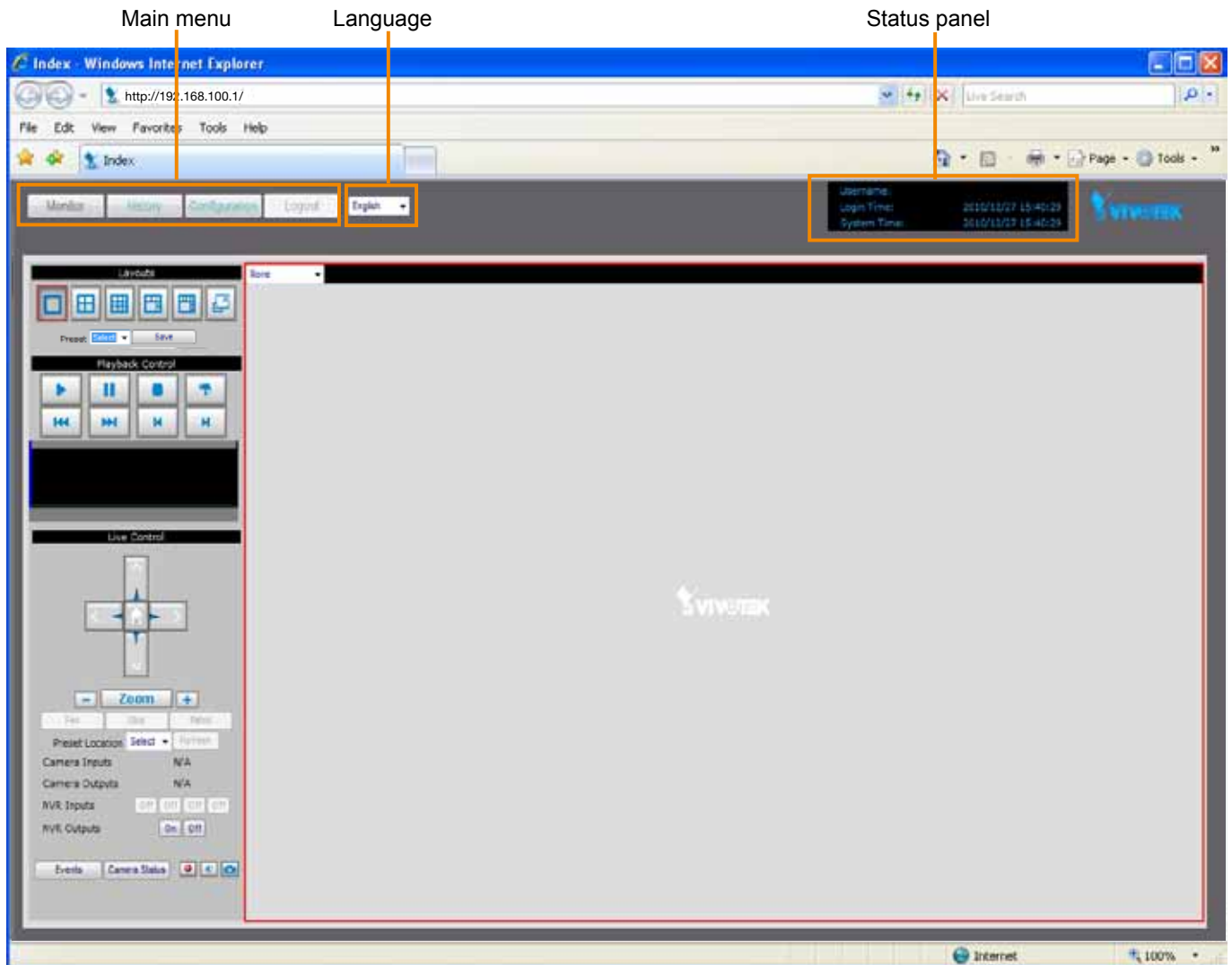

## Main menu

There are four buttons for you to click to open the page:

**Monitor:** Click this button to open the monitoring page. This page is for you to see the live video or playback the recorded data.

**History:** Click this button to open the History page. This page is for you to search and playback recorded data in a specific range of time.

**Configuration:** Click this button to open the Configuration page. This page is for you to configure the settings of the network video recorder. It is suggesting to apply a password for the Network Video Recorder, so that only the authorized user can configure the settings. Please refer to page 19 for detailed information.

**Logout:** Click this button to logout the home page. This button will be enabled if you set up a root password in the Security page. Please refer to page 28 for detailed information.

## Language

Click the drop-down list to choose a language for the user interface. Language options are available in: English, 繁體中文, 簡體中文, 日本語, Français, Español, Deutsch, Português, Italiano.

## Status panel

Username:		User Name (default: root)
Login Time:	2010/12/28 07:47:19	Login Time (yyyy-mm-dd hh:mm:ss)
System Time:	2010/12/28 07:48:14	Current Time (yyyy-mm-dd hh:mm:ss)

### **NOTE**

- ▶ *The Username will be blank if you have not setup a password in the Security page. Please refer to page 28 for detailed information.*
- ▶ *Depending on user's privilege of the user account, the access to the configuration page may be restricted. For more information about user's privilege, please refer to Manage Privilege on page 29.*

# Configuration

This page contains several sub-pages: “Device”, “Network”, “LAN“, “Access list”, “DDNS”, “Security”, “Schedule”, “Recording Policy”, “Trigger”, “Layout”, “System”, “Maintenance”, “Storage“, “Backup”, “System Log“, and “Joystick“. Each sub-page in the left menu will be explained in the following sections.

## Device

This page allows user to add a new device or modify an inserted device. NR8201 supports simultaneous 4-CH video recording, as NR8301 8-CH video recording.

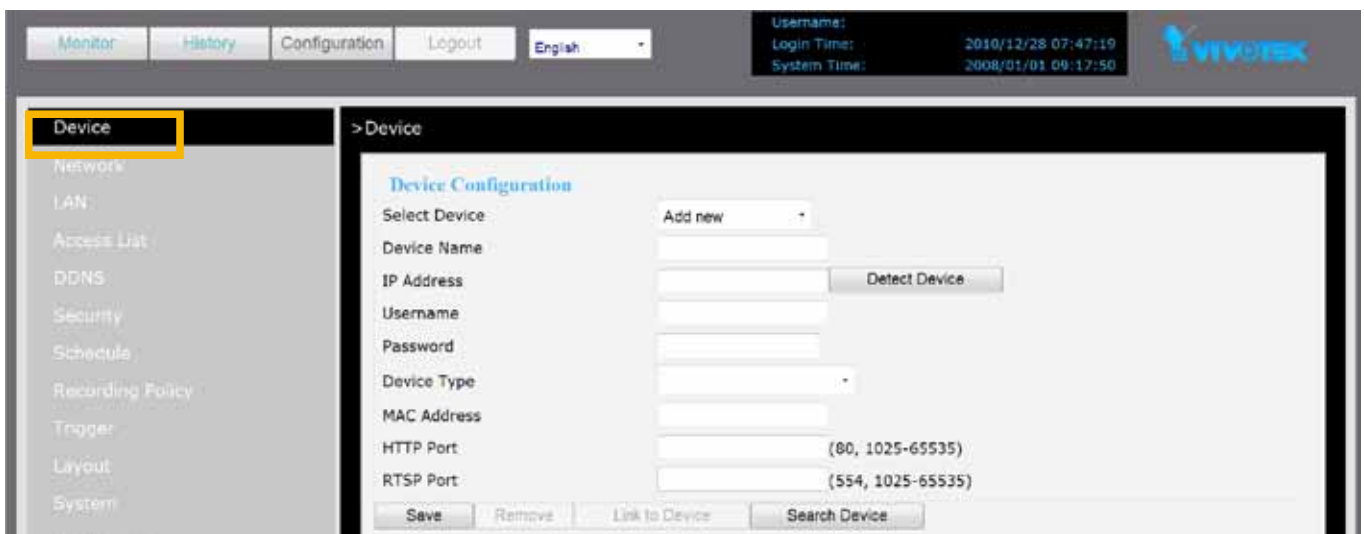

The following is the support list of NR8201 and NR8301. If the camera you wish to add is not on the list, you may choose “unknown” from the list, or you may download the newest firmware updated with the new models.

8000 series	7000 series	6000 series
IP8161	IP7135 / 7137	IP6112/ 22
IP8330	IP7130/ 31/ 32/ 33/ 34/ 38/ 39	IP6117/ 27
IP8332	IP7142	PZ6112/ 22
IP8151/51P	IP7151/ 52/ 53/ 54	PZ6114/ 24
IP8162/62P	IP7160/ 61	FD6111V/ 21V
FD8133	IP7251/ 7330/ 7361	FD6112V/ 22V
FD8134	IZ7151	SD6112V/ 22V
FD8161	PT7135/ 37	
FD8361	PZ7151/ 52	
SD81x1	PZ7111/ 21/ 12/ 31/ 32	
	FD7131/ 32/ 41	
	SD7151/ 73x3	
	VS7100	

## Auto search by device installer or manually install in LAN

If your devices are linked to the LAN port of the Network Video Recorder, you can follow the steps below to add a new device:

1. Click **Search Device**. The searching results will be displayed in the following column. You can click Stop Searching if the linked devices are all displayed on the list.
2. You may wait for a moment while the system is searching for the new devices.
3. Select a device to be inserted. Modify the Device Name if necessary.
4. Click **Add Devices** to enable the settings.
5. Select **Add new** on the drop-down list, and click on the device which you would like to change the network settings.

**Device Configuration**

Select Device: Add new

Device Name:

IP Address:  Detect Device

Username:

Password:

Device Type:

MAC Address:

HTTP Port: (80, 1025-65535)

RTSP Port: (554, 1025-65535)

Save Remove Link to Device **Search Device** 1

**Devices**

Device Type	Device Name	MAC Address	IP Address
System is searching new devices. Please wait.			

Start Searching Stop Searching Add Devices Close

2

**Devices**

Device Type	Device Name	MAC Address	IP Address
IP	IP7130	0:2:d1:9:34:fd	192.168.100.4

Start Searching Stop Searching **Add Devices** Close

3

4

**Device Configuration**

Select Device: Add new

Device Name:

IP Address:  Detect Device

Username:

Password:

5

6. Enter the Username/Password if the device needs to do authentication. The Username/Password must be consistent to the camera's web server. Then, click on **Save**.

The screenshot shows the 'Device Configuration' interface. Fields include: Select Device (IP7130), Device Name (IP7130), IP Address (192.168.100.4), Username, Password, Device Type (VIVOTEK IP7130), MAC Address (02:d1:9:34:fd), HTTP Port (80), and RTSP Port (554). The 'Save' button is highlighted in yellow, and a black circle with the number '6' is positioned next to the Password field.

This section allows you to change the settings for the new device (camera).

The screenshot shows the 'Cameras' configuration page for 'Camera #1'. Settings include: Name (IP7130), Recording Stream (1), Recording Storage (Automatic), Recording Policy (Default), Motion-triggered (checked for Motion Window 1, 2, and 3), and Input-triggered (checked for IP7130-DI-1, and unchecked for NVR-DI-1, 2, 3, and 4). A 'Save' button is at the bottom left.

Name: Enter the Device Name.

Recording Stream: You may choose the stream for recording.

Recording Storage: You may select the storage for recording.

Recording Policy: Choose the recording policy. To know more details, please refer to page 32.

Motion-triggered: Choose the Motion Window. Noted that you need to set up motion windows on the configuration page of the camera first.

Input-triggered: Choose the digital input trigger source, and click **Save** to enable the effect.

The screenshot shows the 'Inputs' and 'Outputs' configuration page. Under 'Inputs', 'Input #1' has the name 'IP7130-DI-1'. Under 'Outputs', 'Relay #1' has the name 'IP7130-DO-1'. Both sections have a 'Save' button.

You may also change the names of the digital input and output source. Click on Save to enable the effect.

You can also manually install a new device in LAN.

Please follow the steps below:

1. Select **Add new** on the drop-down list
2. Enter IP Address.
3. Enter the Username/Password if the device needs to do authentication.
4. Click on **Detect Device**, the Device Type, MAC Address, and HTTP Port will show up in the blanks automatically.
5. Click **Save** to enable the settings.

**Device Configuration**

Select Device: Add new

Device Name: IP8330

IP Address: 192.168.100.2 Detect Device

Username:

Password:

Device Type: VIVOTEK IP8330

MAC Address: 00:02:d1:00:11:33

HTTP Port: 80 (80, 1025-65535)

RTSP Port:  (554, 1025-65535)

Buttons: Save, Remove, Link to Device, Search Device

### Manually install in WAN

When in **WAN**, you have to add a new device **manually**. Please follow the steps below:

1. Select **Add new** on the drop-down list
2. Enter IP Address.
3. Enter the Username/Password if the device needs to do authentication.
4. Click on **Detect Device**, the Device Type, MAC Address, and HTTP Port will show up in the blanks automatically.
5. Click **Save** to enable the settings.
6. If you wish to remove or link to the device, select the device and click "**Remove**" or "**Link to Device**" to remove or link to the device.

### **NOTE**

- If you want to modify the settings of the device, select it on the drop-down list.

**Device Configuration**

Select Device: Add new (dropdown menu open showing: Add new, 0002d18330ef, 0002d1001133, IP8161)

Device Name:

IP Address:  Detect Device

Username:

Password:

Device Type:

MAC Address:

HTTP Port:  (80, 1025-65535)

RTSP Port:  (554, 1025-65535)

The device information will be displayed in the following blanks, and then you can modify the settings of the device. Please refer to page 21 for detailed information.

**Cameras**

Camera #1

Name	IP8151
Recording Stream	1
Recording Storage	Automatic
Recording Policy	Default
Motion-triggered	<input checked="" type="checkbox"/> Motion Window 1 <input checked="" type="checkbox"/> Motion Window 2 <input checked="" type="checkbox"/> Motion Window 3
Input-triggered	<input checked="" type="checkbox"/> IP8162-DI-1 <input type="checkbox"/> NVR-DI-1 <input type="checkbox"/> NVR-DI-2 <input type="checkbox"/> NVR-DI-3 <input type="checkbox"/> NVR-DI-4

**Inputs**

Input #1

Name	IP8162-DI-1
------	-------------

**Outputs**

Relay #1

Name	IP8162-DO-1
------	-------------

## LAN

This page allows user to configure LAN configuration for the Network Video Recorder. It contains two columns: "LAN" and "DHCP Server."

### LAN / DHCP Server

This page allows Administrators to configure network connection in LAN for the Network Video Recorder. It contains two columns: "LAN" and "DHCP Server." In LAN, the default IP Address for the Network Video Recorder is **192.168.100.1**. The default Subnet Mask is 255.255.255.0.



If you set up the network video recorder in LAN and link its LAN Port to network cameras and computer as the picture shows below, the DHCP server of network video recorder will automatically assign IP address to the linked devices. (192.168.100.2 ~ 192.168.100.254)

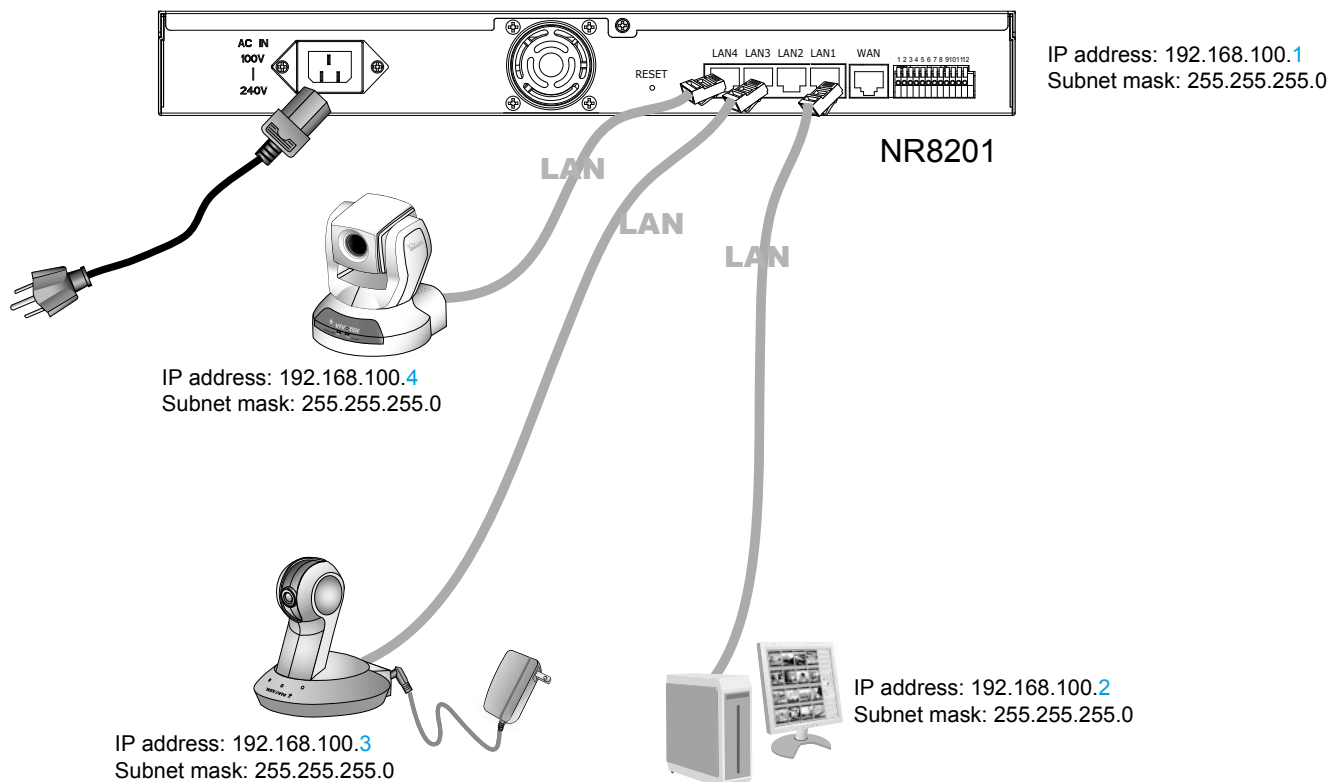

### **NOTE**

- ▶ The starting and ending address of the DHCP server must be in the same subnet as the IP address of the LAN interface of the NR8201/8301.



## Access list

This page allows the user to setup the access permission for the Network Video Recorder by identifying the IP address of the client's PC. Following columns are the setup options of access permissions: "Allowed List", "Denied List".

### Allowed list / Denied list

Allowed List			
Add Entry	Starting IP Address <input type="text"/>	Ending IP Address <input type="text"/>	<input type="button" value="Add"/>
Delete Entry	1.0.0.0~255.255.255.255 -		<input type="button" value="Delete"/>
Denied List			
Add Entry	Starting IP Address <input type="text"/>	Ending IP Address <input type="text"/>	<input type="button" value="Add"/>
Delete Entry	--none-- -		<input type="button" value="Delete"/>

There are two lists for permission control: Allowed list and Denied list. Only the IP on the allowed list is permitted to access to the Network Video Recorder.

1. In the Allowed list or Denied list column, type in the starting IP address and ending address in the blank space on the allowed list and the denied list columns. A number of total 10 IP entries for both lists can be configured.
2. Click **Add** to take effect.

### **NOTE**

- For example, when the range of allowed list is set from 1.1.1.0 to 192.255.255.255 and the range of denied list is set from 1.1.1.0 to 170.255.255.255, Only users' IP located between 171.0.0.0 and 192.255.255.255 can access the Network Video Recorder.

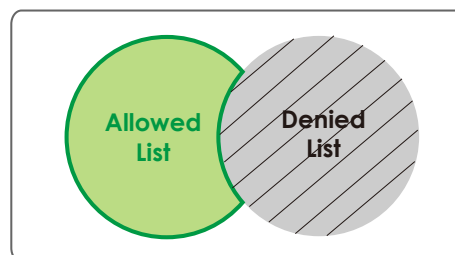

### Delete allowed list / Delete denied list

1. In the Delete allowed list or Delete denied list, select a list from the drop-down list.
2. To delete the entry, please select the entry from the list and click delete to take effect.

## DDNS

This page allows user to configure dynamic domain name service for the Network Video Recorder. DDNS (Dynamic domain name service) is a service that allows your network video recorder to be assigned with a fixed dynamic IP address with a domain name.

### DDNS Settings

**Select DDNS Service:** Select a DDNS provider from the Provider drop-down list.

VIVOTEK offers Safe100.net, a free dynamic domain name service to VIVOTEK customers. It is recommended that you register with the Safe100.net to access the Network Video Recorder from the Internet. Additionally, we offer other DDNS providers, such as Dyndns.org, DHS.org, TZO.com, dyn-interfree.it.

Note that to utilize this feature, please apply a dynamic domain account first.

#### ■ Safe100.net

1. Select www.safe100.net on the Provider drop-down list.
2. Click **I Accept** when you agree with the terms of the Service Agreement.

3. In the Register column, fill in the Host name, Email, Key and Confirm Key and then click **Register**. You will receive a "Self registration E-mail" which records your account information.

4. Back to the DDNS settings window, enter your account information and then click **Save** to enable the settings.

**Forget key:** Click this button if you forget the key of Safe100.net. Your account information will be sent to your e-mail address.

Please refer to the following links to apply a dynamic domain account when selecting other DDNS providers:

- [Dyndns.org \(Dynamic\)](http://www.dyndns.org) / [Dyndns.org \(Custom\)](http://www.dyndns.org): visit <http://www.dyndns.com/>
- [TZO.com](http://www.tzo.com/): visit <http://www.tzo.com/>
- [DHS.org](http://www.dns.org/): visit <http://www.dns.org/>
- [dyn-interfree.it](http://dyn-interfree.it/): visit <http://dyn-interfree.it/>

## Security

This page allows Administrator to enable password protection and create multiple user accounts for the Network Video Recorder. It is composed of the following three columns: "Root Password", "Manage Privilege", and "Manage User".

### Root Password

If you want to add more accounts in Manage User column, please apply a password for the "root" account first. Please follow the steps below to set up root password:

1. Enter the password identically in both text boxes.
2. Click **Save** to enable password protection.

3. The following window will automatically pop up for you to login. Enter the administrator username as "root", which is permanent and can not be changed. Enter the root password you've just setup, and then click **Login** to link to the page.

3. The **Logout** button on the Main Menu will be enabled after you set up a root password.

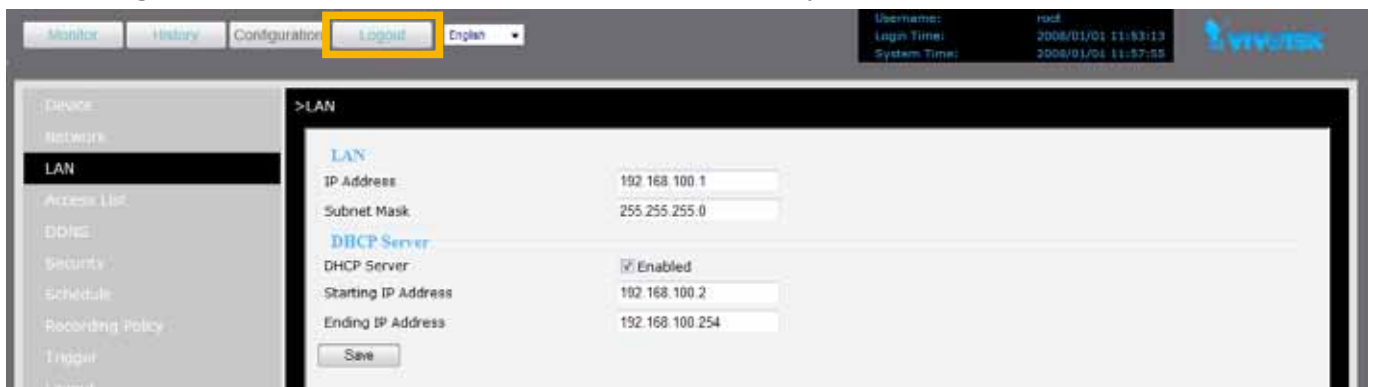

## Manage Privilege

	Operator	Viewer
System Configuration	<input type="checkbox"/>	<input type="checkbox"/>
Device Configuration	<input checked="" type="checkbox"/>	<input type="checkbox"/>
Live Control	<input checked="" type="checkbox"/>	<input type="checkbox"/>
Playback Control	<input checked="" type="checkbox"/>	<input type="checkbox"/>

Save

In this section, you can modify the manage privilege of operators or viewers. Check or uncheck the item, and then click **Save** to take effect.

Following is the privilege list of different user accounts:

User privileges	Administrator	Operator	Viewer
System Configuration	O	X	X
Device Configuration	O	O	X
Live Control (Monitor page)	O	O	O
Playback Control (History page)	O	O	O

### **NOTE**

- ▶ *The user privileges of an administrator are always enabled and unchangeable .*
- ▶ *Operator and Viewer don't have the permission to the Configuration page.*

## Manage User

Select User: Add new ▾

User Name:

User Password:

Confirm User Password:

Privilege: Administrator ▾  
Administrator  
Operator  
Viewer

Save Remove

- Administrator can add up to twenty user accounts.
  1. Enter the new user's name and password.
  2. Select the Privilege for new user account. Click **Save** to take effect.
- Here you also can change user's privilege or delete user accounts.
  1. Select an account on the drop-down list.
  2. Make necessary changes and then click **Save** or **Remove** to take effect.

### **NOTE**

- ▶ *NR8201/8301 allows up to 10 users to login to the webpage simultaneously.*

## Schedule

This page allows Administrator to add a new Recording Schedule or modify an existing Schedule for the Network Video Recorder. You can configure up to 16 recording schedules based on a weekly basis.

By default setting, all inserted device are assigned to the default recording schedule (always). Therefore, once you insert a device to the network video recorder, it will begin to record live video continuously.

The screenshot shows the 'Schedule Configuration' interface. It includes a 'Schedule Configuration' section with a 'Select Schedule' dropdown (set to 'Add new') and a 'Name' input field. Below is the 'Schedule Entries' section with 'Add Entry' and 'Delete Entry' options, each with 'Begin' and 'End' time and day selectors. The 'Schedule Display' section shows a grid of days from Sunday to Saturday, with a grey bar indicating a recording schedule.

■ Please follow the steps below to add a new recording schedule:

1. Enter a descriptive name for the new schedule.
2. Select a day and enter a time frame (in the format of 24hr).
3. Click **Add** to take effect. The new recording schedule will show up in the Schedule Display column. You can add more than one time frames under the same schedule name.

Following is an example of recording schedule (Mon.~Fri. 09:00~12:00).

This screenshot shows the 'Schedule Configuration' interface with annotations. Annotation 1 points to the 'Name' input field containing 'schedule 1'. Annotation 2 points to the 'Add Entry' section, specifically the 'Begin' and 'End' time and day selectors, which are set to 'Monday 09:00~Monday 12:00'. Annotation 3 points to the 'Add' button. The 'Schedule Display' section shows a grid of days from Sunday to Saturday, with a yellow bar indicating a recording schedule from Monday to Friday, 09:00 to 12:00.

- The new recording schedule will show up on the Recording Mode as below. Notice that to enable the schedule, you may set up a recording policy first. Please refer to page 32 to continue the setting.

The new recording schedule will also show up on the Trigger Configuration as below. Click **Trigger** on the left Menu. Then you can select **Always**, **Never**, or **schedule1** as your schedule for event trigger.

- If you want to delete a recording schedule, select it on the drop-down list (Select Schedule) and then click **Remove** to delete it.
- If you want to delete a time frame, select it on the drop-down list (Delete Entry) and then click **Delete**.

## Recording Policy

This page allows user to set up recording policy for linked cameras. By default setting, all inserted cameras are assigned to the default recording schedule (always), default recording type (continuous mode), and default recording policy (save continuous recording for 30days). Therefore, once you insert a camera to the Network Video Recorder, it begins to record live video continuously and save "30 days" of recorded videos. You may go to History page to retrieve the videos.

For example:

The user adds a VIVOTEK IP8162 camera to NR8201/8301. Following pictures shows the default settings:

### ■ Configuration > Device

**Cameras**  
Camera #1

Name: IP8162

Recording Stream: 1

Recording Storage: Automatic

**Recording Policy: Default**

### ■ Configuration > Recording Policy

**Recording Mode**

Add Entry: Schedule **Always**

Event Mode  Motion-triggered  Input-triggered

Continuous Mode

Delete Entry: --none--

Buttons: Save, Remove, Add, Delete

### ■ Recorded video clips on **History** page.

Start Time	Length	Size(KB)	Recording	
2011/01/26 16:41:20	02'38"	151756	Continuous	
2011/01/26 16:43:59	02'38"	151992	Continuous	
2011/01/26 16:46:37	02'38"	152791	Continuous	
2011/01/26 16:49:16	02'38"	153566	Continuous	
2011/01/26 16:51:55	02'38"	152692	Continuous	
2011/01/26 16:54:34	02'38"	152487	Continuous	
2011/01/26 16:57:12	02'38"	152925	Continuous	
2011/01/26 16:59:51	00'42"	40440	Continuous	

For detailed information about the History page, please refer to page 52.



This page allows Administrator to add/modify a new Recording Policy and Recording Mode. There are 4 types of Recording Policy for the user to configure properly.

- Please configure the following items to add a new Recording Policy/Recording Mode:

## Recording Policy

Recording Type	Time Period	Pre-time	Post-time
Save Continuous Recording	30 Days	-	-
Save Motion Recording	30 Days	0 Second	30 Seconds
Save Input Recording	30 Days	0 Second	30 Seconds
Save Manual Recording	30 Days	-	-

Select Policy: Select Add new.

Name: Enter a descriptive name for the new recording policy.

Save Continuous Recording: Select an option of the time period (1 Hour, 1 Day, 1 Week, 2 Weeks, 30 Days, 90 Days, 180 days, or 365days) as the time of the continuous recorded videos.

Save Motion Recording: Select an option of the time period (1 Hour, 1 Day, 1 Week, 2 Weeks, 30 Days, 90 Days, 180 days, or 365days) as the time of the motion-triggered recorded videos.

- **Pre-motion Time**: Select an option of the time period (0 Seconds, 10 Seconds, 30 Seconds, 1 Minute, or 5 Minutes) as pre-motion time. Pre-motion records the video in a pre-set time period before the event and merges the recorded event into one combined video.

- **Post-motion Time**: Select an option of the time period (30 Seconds, 1 Minute, or 5 Minutes) post-motion time. Post-motion records the video in a post-set time period after the event and merges the recorded event into one combined video.

Save Input Recording: Select an option of the time period (1 Hour, 1 Day, 1 Week, 2 Weeks, 30 Days, 90 Days, 180 days, or 365days) as the time of the input-triggered recorded videos.

- **Pre-input Time**: Select an option of the time period (0 Seconds, 10 Seconds, 30 Seconds, 1 Minute, or 5 Minutes) as pre-input time.

- **Post-input Time**: Select an option of the time period (30 Seconds, 1 Minute, or 5 Minutes) as post-input time.

Save Manual Recording: Select an option of the time period (1 Hour, 1 Day, 1 Week, 2 Weeks, 30 Days, 90 Days, 180 days, or 365days) as the time of the manual recorded videos.

## Recording Mode

**Add Entry:** Select the event mode or continuous mode to apply to the schedule as an entry.

- **Event Mode:** Select to apply the motion-triggered type, input-triggered type or both types of the event mode to the schedule.
- **Continuous Mode:** Select to apply the continuous mode to the schedule.



Click **Add**, the new recording mode will show up in the Delete Entry drop-down list. To select a recording mode, please select it in the Delete Entry drop-down list, and click **Delete**. When finished, click **Save** to take effect.

If you wish to remove the recording policy, go to Recording policy section and select the given recording policy first. Then, click **Remove**. See below.

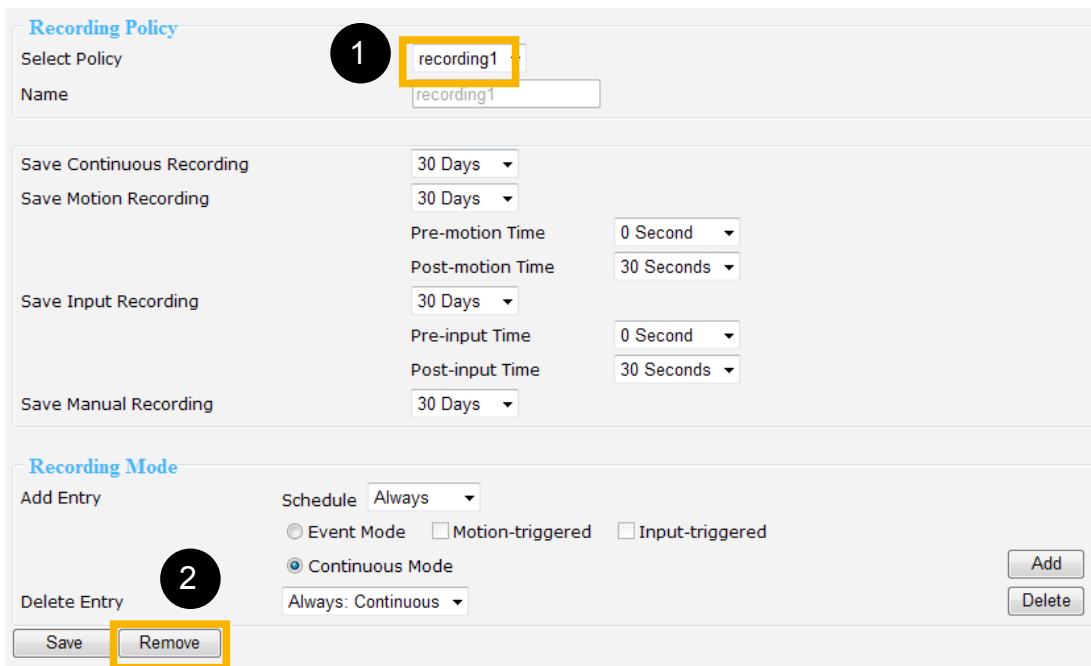

The new recording policy will show up on the device information as below. Click **Device** on the left Menu. Then you can select **Default** or **recording1** as your recording policy.

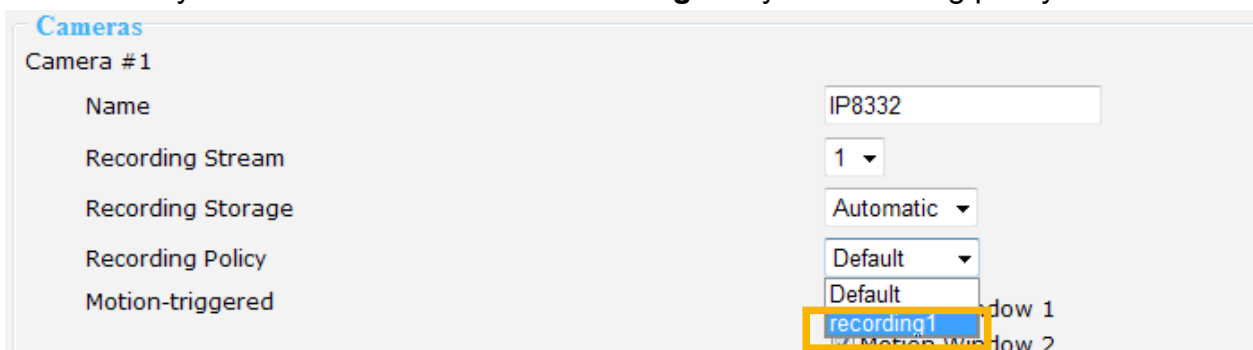

## Trigger

This page allows Administrator to configure the Network Video Recorder to react in response to particular triggered events. A typical reaction is that when a motion is detected by the network camera, the Network Video Recorder sends buffered images to a FTP server or E-mail address as notifications. Sixteen sets of events are available for triggering.

In the following illustration, an event can be triggered by many sources, such as motion detection or external alarm (digital input devices). When an event is triggered, you can specify what kind of action should be performed. You can assign the Network Video Recorder to send notifications to your e-mail address or FTP site.

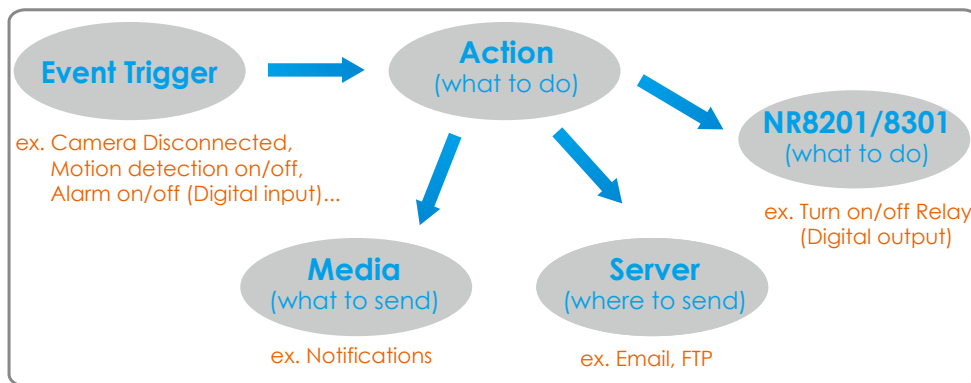

- Please configure the following items to add a new trigger type of event.

### Trigger Configuration

Select Trigger Add new ▼

Name

Schedule Always ▼

---

### Trigger Event

Camera Disconnected IP8162 ▼

Camera Motion On IP8162 ▼

Camera Motion Off IP8162 ▼

Camera Video Lost On ▼

Camera Video Lost Off ▼

Alarm On NVR-DI-1 ▼

Alarm Off NVR-DI-1 ▼

---

### Trigger Action

Email Notification

FTP Notification

Turn On Relay NVR-DO-1 ▼

Turn Off Relay NVR-DO-1 ▼

## Trigger Configuration

Select Trigger: Select Add new.

Name: Enter a descriptive name for the new event trigger.

Schedule: Select a recording schedule on the drop-down list (**Always**, **Never**, or **pre-set recording schedule**).

## Trigger Event

### 1. From linked devices

Select one of the following event source, and then select a linked device.

Camera Disconnected: Linked Device is disconnected.

Camera Motion On: Motion detection window is triggered on linked Device.

Camera Motion Off: Motion detection window is stopped on linked Device.

Camera Video Lost On: Video lost happens on linked Device (ex. VIVOTEK video server VS7100).

Camera Video Lost Off: Video lost ends on linked Device (ex. VIVOTEK video server VS7100).

Alarm On: Alarm (external digital input) is triggered on linked Device. This function will only be enabled on the devices with DI function.

Alarm Off: Alarm (external digital input) is off on linked Device. This function will only be enabled on the devices with DI function.

### 2. From the network video recorder

Select one of the following source; and then select a digital input.

Alarm On: Alarm (external digital input NVR-D1-1 ~ NVR-D1-4) is triggered on the network video recorder.

Alarm Off: Alarm (external digital input NVR-D1-1 ~ NVR-D1-4) is off on the network video recorder.

## **NOTE**

- ▶ *You can modify the Name and priority of digital inputs on the network video recorder. Please refer to Digital Input on page 41 for detailed information.*

## Trigger Action

To plot an event trigger, please select one of a following action so that the Network Video Recorder will know what action should be performed when a trigger is activated.

### 1. Actions of the system

Please click **System** on the left main menu to configure **E-mail server or FTP server** settings first. Please refer to page 40 for detailed configuration.

Email Notification: Send \*.txt notification to user's e-mail address.

FTP Notification: Send \*.txt notification to user's FTP site.

### 2. Actions of the linked devices

Turn On Relay: Turn on Relay (digital output) on linked device. This function will only be enabled on the devices with DO function.

Turn Off Relay: Turn off Relay (digital output) on linked device. This function will only be enabled on the devices with DO function.

### 3. Actions of the network video recorder

Turn On Relay: Turn on Relay (digital output do0) on the network video recorder.

Turn Off Relay: Turn off Relay (digital output do0) on the network video recorder.

#### **NOTE**

► You can modify the Name of digital outputs on the network video recorder. Please refer to Digital Onput on page 41 for detailed information.

► E-mail & FTP notification

#### 1. E-mail format:

Event Type	Camera disconnected	Motion on	Motion off	Alarm on	Alarm off
Title	Event notification from Device Y: Camera disconnected	Event notification from Device Y: motion_on	Event notification from Device Y: motion_off	Event notification from Device Y: alarm_on	Event notification from Device Y: alarm_off
Content	Device Y is disconnected	Device Y motion # X on	Device Y motion # X off	Device Y DI Device Y-DI-X on	Device Y DI Device Y-DI-X on
With Snapshot (jpg.)	No	Yes	Yes	Yes	Yes

#### 2. FTP format

Event Type	Camera disconnected	Motion on	Motion off
Snapshot	No snapshot	motion on_Z_MAC address_date&time_random number.jpg	mottion off_Z_MAC address_date&time_random number.jpg

Event Type	Alarm on	Alarm off
Snapshot	alarm on_Z_MAC address_date&time_random number.jpg	alarm off_Z_MAC address_date&time_random number.jpg

- "Y" refers to the Device Name. For example, IP8162. (Y=8162)
- "X" refers to the motion window number of the device in Motion on and Motion off notification, while it refers to digital input number in Alarm on and Alarm off notification.  
For example, Camera IP8162 mortion #1 on (X=1)  
Device IP8151 DI IP8151-DI-2 on (X=2)
- "Z" refers to the motion window number of the device. Noted that Z number 0,1,2 indicates the motion window 1,2,3.  
For example, motion\_on\_0\_2d18332af00\_20110214065122\_371.jpg (Z=0, Z= motion window 1)
- Date should be in **YYYYMMDD\_HHMMSS** format.  
For example: **20080509\_122342\_Motionon.jpg**
- Only the event of the linked cameras will send snapshot notification.

## Layout

This page allows Administrator to configure the customized layout styles for monitoring. The settings are composed of the following two columns: Layout Configuration, and Default Layout, of which allow you to add and edit the layout group by assigning the desired device (camera) to each viewing cell. Meanwhile, the setting will be synchronized to the monitoring page for a quick viewing.

### Layout Configuration

**Layout Configuration**

Select Layout: layout1

Name: layout1

Type: 1+5

Cell 1	--none--	Cell 2	--none--	Cell 3	--none--
Cell 4	--none--	Cell 5	--none--	Cell 6	--none--
Cell 7	--none--	Cell 8	--none--	Cell 9	--none--

Save Remove

**Select layout:** Choose **Add new**.

**Name:** Enter a name for the new layout.

**Type:** Choose a desired type (1x1,2x2,3x3,1+5,1+7) for the display in live viewing window on the monitoring page. Noted that there are only two types of layout (1x1,2x2) supported in NR8201.

**Cells:** You can assign a device and select a stream of the assigned device for each cell. Noted that there are up to 4 cells for NR8201, and up to 9 cells for NR8301.

**Save:** Click **Save** to save the new layout.

**Remove:** Select the layout you want to remove, and click **Remove**.

Once the layout configuration is done, you may go to the monitor page to confirm the layouts.

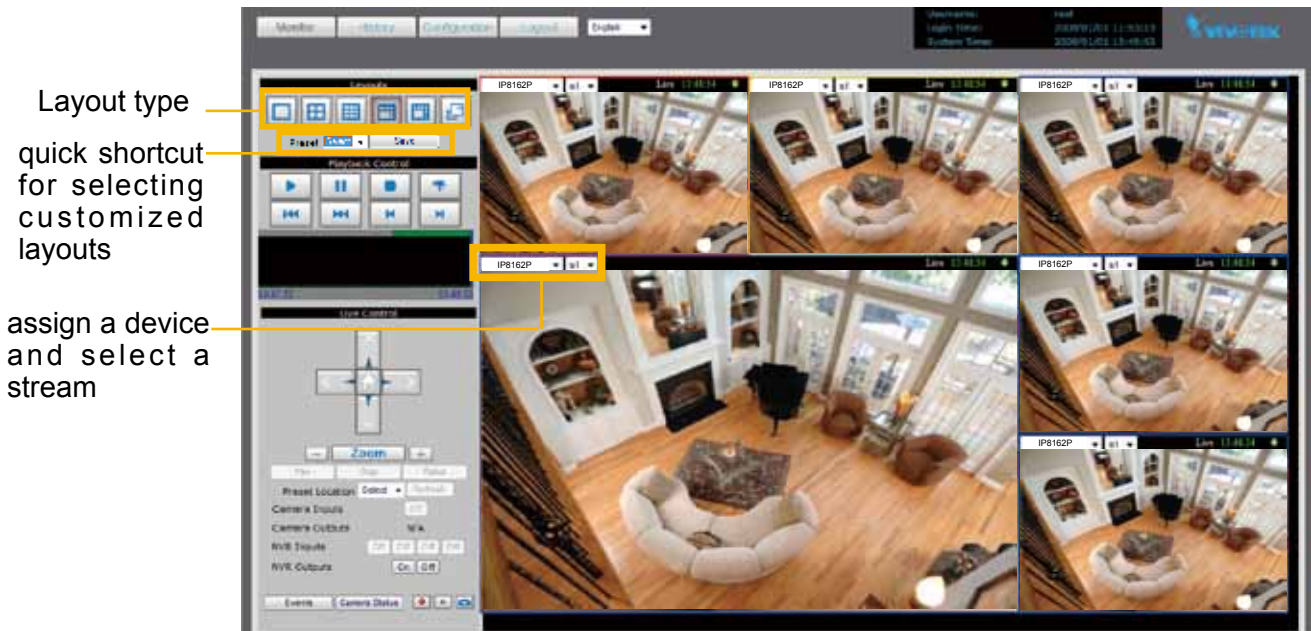

### Default Layout

**Default Layout**

User Default Layout: Select

Set to Default

Select a layout you've set in Layout Configuration column, and click Save Default to enable the setting.

## System

This page allows Administrator to configure the system settings for the Network Video Recorder, Formed with the following columns; system, system time, E-mail server, FTP server, digital inputs, digital output and VAST.

### System

System		
Host Name	<input type="text" value="NR8301 for Jimmy"/>	<input type="button" value="Save"/>
Device Automatic Installation	<input type="checkbox"/> Enabled	<input type="button" value="Save"/>
Snapshot and Download Path	<input type="text"/>	<input type="button" value="Save"/>

Host Name: Add a host name for the system identification.

Device Automatic Installation: Check **Enable**, and the system will automatically detect the plugged-in camera. Then click **Save**.

Snapshot and Download Path: The path defines where the system stores the snapshot of both live monitoring and playback, and the downloaded video from history. It has to be setup before executing the snapshot and download functions.

### System Time

System Time		
<input checked="" type="radio"/> Keep current date and time	2011/02/14 10:45:09	
<input type="radio"/> Sync with computer time	2011/02/14 11:47:28	
<input type="radio"/> Manual	<input type="text" value="2011/02/14"/> [yyyy/mm/dd]	<input type="text" value="10:45:04"/> [hh:mm:ss]
<input type="radio"/> Automatic	<input type="text"/>	
<input type="button" value="Save"/>		

Select one of the following option as the system time displaying in the status panel on top right of the monitor page. Please refer to page 18 for detailed information.

Keep current date and time: Select this option to reserve the current date and time of the Network Video Recorder. The Network Video Recorder's internal real-time clock maintains the date and time even when the power of the system is turned off.

Sync with computer time: Select this option to synchronize the date and time of the Network Video Recorder with the local computer. The read-only date and time of the PC is displayed as updated.

Manual: The administrator can enter the date and time manually. Note that the date and time format are [yyyy/mm/dd] and [hh:mm:ss].

Automatic: The Network Time Protocol is a protocol serves synchronize computer clocks by periodically querying an NTP Server. Assign the IP address or domain name of the time-server.

## E-mail Server

Email Server	
Mail Enabled	<input checked="" type="checkbox"/> Enabled
Mail Server	Ms.vivotek.tw
Port	25
Username	vivotek
Password	••••
Sender Email Address	NR8301@vivotek.com
Recipient Email Address	vivotek@vivotek.com
<input type="button" value="Save"/> <input type="button" value="Send Test Email"/>	

Mail Server: Enter the domain name or IP address of the e-mail server.

Port: The default mail server port is set to 25. You can manually set another port.

Username: Enter the user name of the e-mail account.

Password: Enter the password of the e-mail account.

Sender Email Address: Enter the e-mail address of the sender.

Recipient Email Address: Enter the e-mail address of the recipient.

When the setup is done, you may try to confirm the settings by clicking on **Send test E-mail**. Then, click **Save** to enable the settings.

## FTP Server

FTP Server	
FTP Enabled	<input checked="" type="checkbox"/> Enabled
FTP Server	ftp://vivotek.com.tw
Port	21
Username	vivotek
Password	••••
Folder	
<input type="button" value="Save"/> <input type="button" value="Send Test FTP"/>	

FTP Server: Enter the domain name or IP address of the FTP server.

Port: By default, the FTP server port is set to 21. It can also be assigned to another port number between 1025 and 65535.

Username: Enter the login name of the FTP account.

Password: Enter the password of the FTP account.

Folder: Enter an existing folder on FTP sever to place the media file.

When the setup is done, you may try to confirm the settings by clicking on **Send test FTP**. Then, click **Save** to enable the settings.



## Digital Input



The screenshot shows a configuration window titled "Inputs". It contains four text input fields, each with a label and a value:

Label	Value
Input #1 Name	NVR-DI-1
Input #2 Name	NVR-DI-2
Input #3 Name	NVR-DI-3
Input #4 Name	NVR-DI-4

At the bottom of the window is a "Save" button.

In the digital input section, you may modify the name of the external digital inputs.

## Digital Output

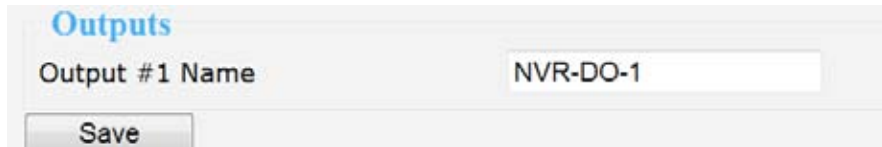

The screenshot shows a configuration window titled "Outputs". It contains one text input field with a label and a value:

Label	Value
Output #1 Name	NVR-DO-1

At the bottom of the window is a "Save" button.

In the digital output section, you may modify the name of the external digital output.

## VAST

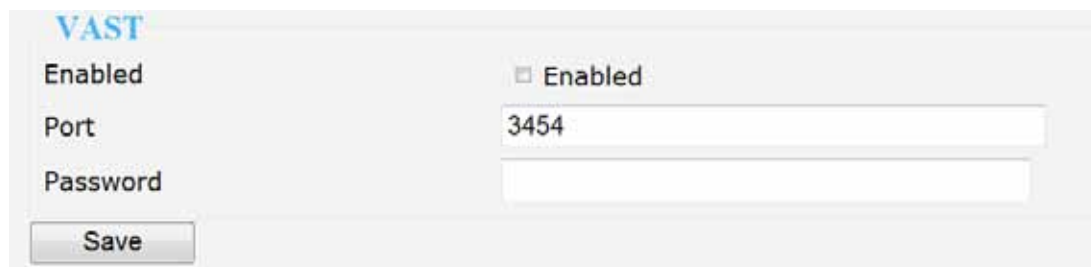

The screenshot shows a configuration window titled "VAST". It contains three fields and a checkbox:

Field	Value
Enabled	<input checked="" type="checkbox"/> Enabled
Port	3454
Password	

At the bottom of the window is a "Save" button.

This section allows you to enable the service for VAST to connect to the NVR. The port is set to 3454 by default. It requires a password for authentication. Noted that the maximum live connection is 10, and the connection for VAST counts one live connection in the system.

## Maintenance

This page allows Administrator to restore the Network Video Recorder to factory default, format hard disk, and upgrade firmware version, etc.

### System



**Reboot:** This function allows you to restart the Network Video Recorder. It takes 1 ~ 2 minutes to complete the process. If the connection fails after rebooting, manually enter the IP address of the Network Video Recorder in the address field to resume the connection.

**Restore Default Except Network Settings:** This function allows you to restore to the factory default settings without the network settings. (WAN / LAN / Host name settings).

**Restore Factory Default:** This function allows you to restore to the factory default settings. Please note the camera list of device page will no longer exist. The recorded video will still remain and retrievable in history.

The process window will display when the reboot or restore is in processing.

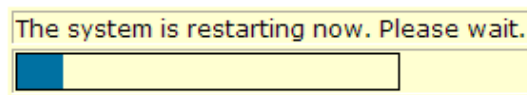

**Download Configuration:** Click **Download** to save the configuration. Please note the configuration of NR8201 and NR8301 cannot be used for one the other.

**Upload Configuration:** Click **Browse** and specify the configuration file in your computer. Then click **Upload** to replaced the configuration with the uploaded file.

### Firmware

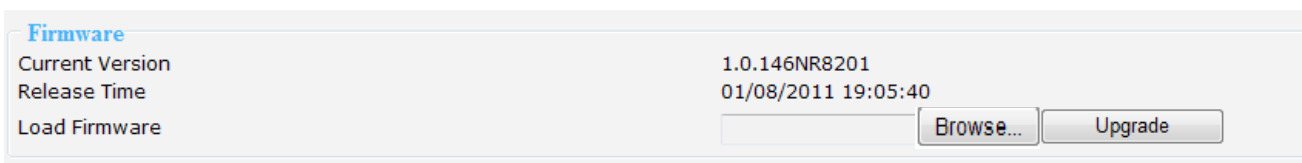

This feature allows you to upgrade the firmware to your Network Video Recorder. Download a new firmware file from VIVOTEK website. The file is in .upt file format.

In this section, it shows the version and released time of the current firmware for verification. You may start to load the latest firmware to your computer, and then click **Upgrade** to start the process. Please note that do not power off NVR during the process. The NVR will reboot automatically when the upgrade is complete.

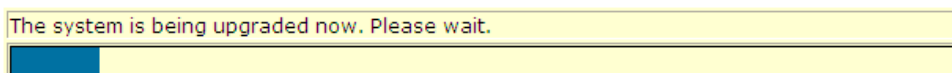

## Storage

This column shows the information of your internal hard disk, USB, and eSATA. For the first time you install the hard disk, please format it before recording. In addition, if you want to delete all recorded data, you can click **Format** to clean the hard disk. The following message is displayed during the formatting process.

### ■ NR8201

**Internal Hard Disks**

Model	WDC WD5000AADS-0
Status	Active
Total Size(GB)	465.76

---

**USB**

Not Available

---

**eSATA**

Not Available

### ■ NR8301

**Internal Hard Disks**

	Disk 1	Disk 2
Model	ST32000641AS	ST3250823AS
Status	Active	Active
Total Size(GB)	1863.02	232.89
Free Size(GB)	1629.82	4.40

---

**USB**

Model	41AS
Status	Active
Total Size(GB)	1397.27
Free Size(GB)	-

The system is formatting hard disks now. Please wait.

## RAID

**RAID**

Status None

NR8301 supports RAID 0, 1 as for storage management. You may choose to format the hard disks to RAID 0 or RAID 1. Once the RAID pattern is applied to the hard disks, the storage space will follow the RAID system. If you replace the hard disks, you can click **Recover RAID** button to recover the preset RAID system. If you want to disable the RAID mode, please format both of the hard disks.

### **NOTE**

► Please remember to click **Eject** before removing the eSATA and USB device.

**eSATA**

Model	WDC WD5000AADS-0
Status	Active
Total Size(GB)	465.76

**eSATA**

Model	WDC WD5000AADS-0
Status	Active
Total Size(GB)	465.76

## Backup

This function allows Administrator to backup the recorded data to the USB storage. Please remember to initialize the USB disk to **EXT3** USB Storage file format for the first time.

### Scheduled Backup

**Scheduled Backup**

Backup Enabled	<input type="checkbox"/> Enabled
Backup Continuous Recording	<input type="checkbox"/> Enabled
Backup Motion-triggered Recording	<input type="checkbox"/> Enabled
Backup Input-triggered Recording	<input type="checkbox"/> Enabled
Backup Manual Recording	<input type="checkbox"/> Enabled
Backup Time	Never <span style="border: 1px solid #ccc; padding: 2px;">08:00</span>

There are several options for you to narrow down the range of the data. First of all, it is necessary to enable backup, and then you may select the backup options individually or simultaneously. Next is pick up the backup date and time and then click **Save** to execute it.

### Manually Backup

**Manual Backup**

Backup Continuous Recording	<input type="checkbox"/> Enabled
Backup Motion-triggered Recording	<input type="checkbox"/> Enabled
Backup Input-triggered Recording	<input type="checkbox"/> Enabled
Backup Manual Recording	<input type="checkbox"/> Enabled
Select Time	Today <span style="border: 1px solid #ccc; padding: 2px;">▼</span>

There are several options for you to narrow down the range of the data. First of all, it is necessary to enable backup, and then select the backup options individually or simultaneously. Next is pick up the backup date and time and then click save to execute it.

### USB

USB	
Model	USB DISK
Status	Uninitialized
Total Size(GB)	0.48
Free Size(GB)	-

Your backup data will be stored in USB. Once you plug in the device, the system will display the current USB status as shown above.

## System log

This column displays the system log in chronological order. The system log is stored in the Network Video Recorder's buffer area and will be overwritten when reaching a certain amount. Click **Refresh**, it will update the latest system log.

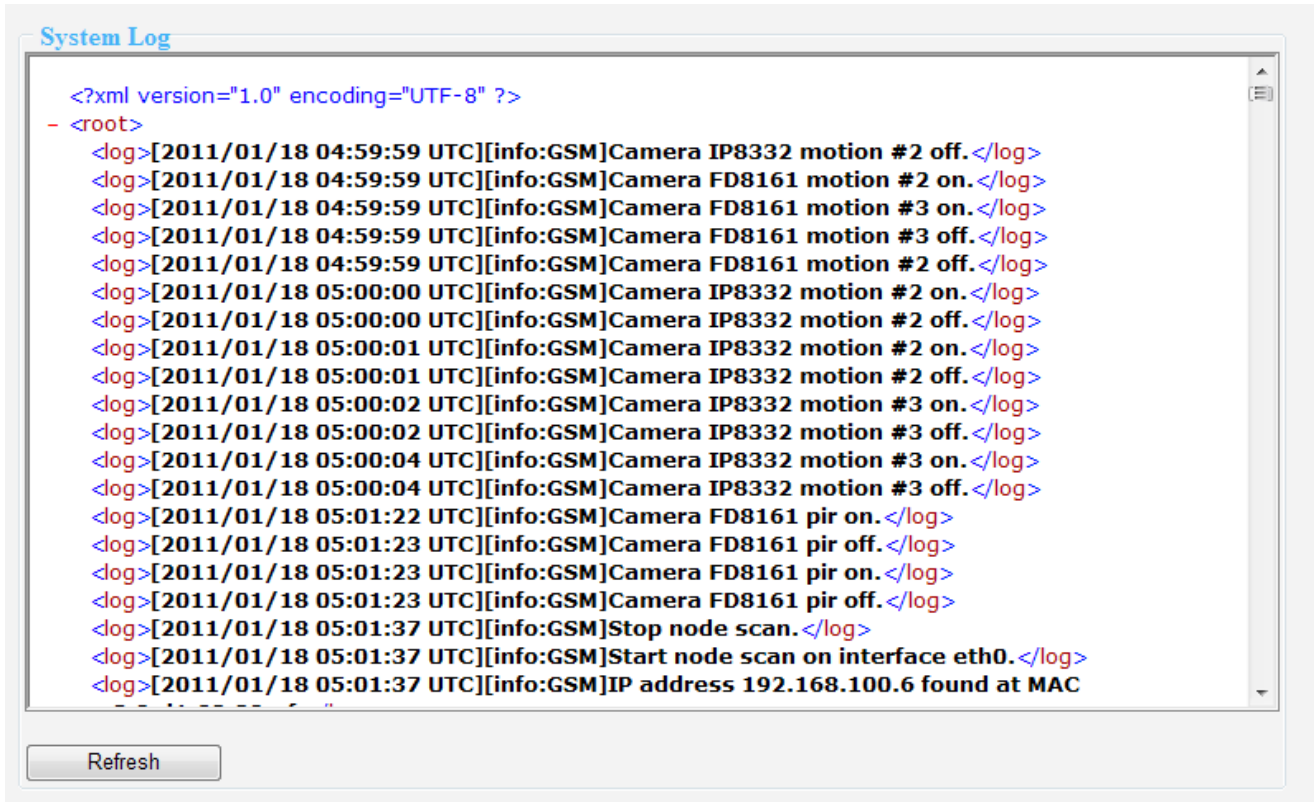

The screenshot shows a window titled "System Log" with a text area containing XML-formatted log entries. The entries are as follows:

```
<?xml version="1.0" encoding="UTF-8" ?>
- <root>
  <log>[2011/01/18 04:59:59 UTC][info:GSM]Camera IP8332 motion #2 off.</log>
  <log>[2011/01/18 04:59:59 UTC][info:GSM]Camera FD8161 motion #2 on.</log>
  <log>[2011/01/18 04:59:59 UTC][info:GSM]Camera FD8161 motion #3 on.</log>
  <log>[2011/01/18 04:59:59 UTC][info:GSM]Camera FD8161 motion #3 off.</log>
  <log>[2011/01/18 04:59:59 UTC][info:GSM]Camera FD8161 motion #2 off.</log>
  <log>[2011/01/18 05:00:00 UTC][info:GSM]Camera IP8332 motion #2 on.</log>
  <log>[2011/01/18 05:00:00 UTC][info:GSM]Camera IP8332 motion #2 off.</log>
  <log>[2011/01/18 05:00:01 UTC][info:GSM]Camera IP8332 motion #2 on.</log>
  <log>[2011/01/18 05:00:01 UTC][info:GSM]Camera IP8332 motion #2 off.</log>
  <log>[2011/01/18 05:00:02 UTC][info:GSM]Camera IP8332 motion #3 on.</log>
  <log>[2011/01/18 05:00:02 UTC][info:GSM]Camera IP8332 motion #3 off.</log>
  <log>[2011/01/18 05:00:04 UTC][info:GSM]Camera IP8332 motion #3 on.</log>
  <log>[2011/01/18 05:00:04 UTC][info:GSM]Camera IP8332 motion #3 off.</log>
  <log>[2011/01/18 05:01:22 UTC][info:GSM]Camera FD8161 pir on.</log>
  <log>[2011/01/18 05:01:23 UTC][info:GSM]Camera FD8161 pir off.</log>
  <log>[2011/01/18 05:01:23 UTC][info:GSM]Camera FD8161 pir on.</log>
  <log>[2011/01/18 05:01:23 UTC][info:GSM]Camera FD8161 pir off.</log>
  <log>[2011/01/18 05:01:37 UTC][info:GSM]Stop node scan.</log>
  <log>[2011/01/18 05:01:37 UTC][info:GSM]Start node scan on interface eth0.</log>
  <log>[2011/01/18 05:01:37 UTC][info:GSM]IP address 192.168.100.6 found at MAC
```

Below the text area is a "Refresh" button.

## Joystick

NR8201/8301 supports the use of VIVOTEK's joystick. You can control your PTZ cameras through it. It is simple as plugging it into the USB connector on the PC and refresh the NVR Configuration page. The joystick functional buttons support to be assigned with commands as zoom in/out, pan, stop, patrol, start/stop manual recording, mute/unmute, snapshot, play/pause, live, stop playing, fast forward/fast rewind, previous/next, turn on/turn off NVR digital output, enter/exit full screen mode, and preset 1 ~ 16. You can assign up to 10 commands to the 10 buttons of joystick for control. Click **Save** when the setup is complete.

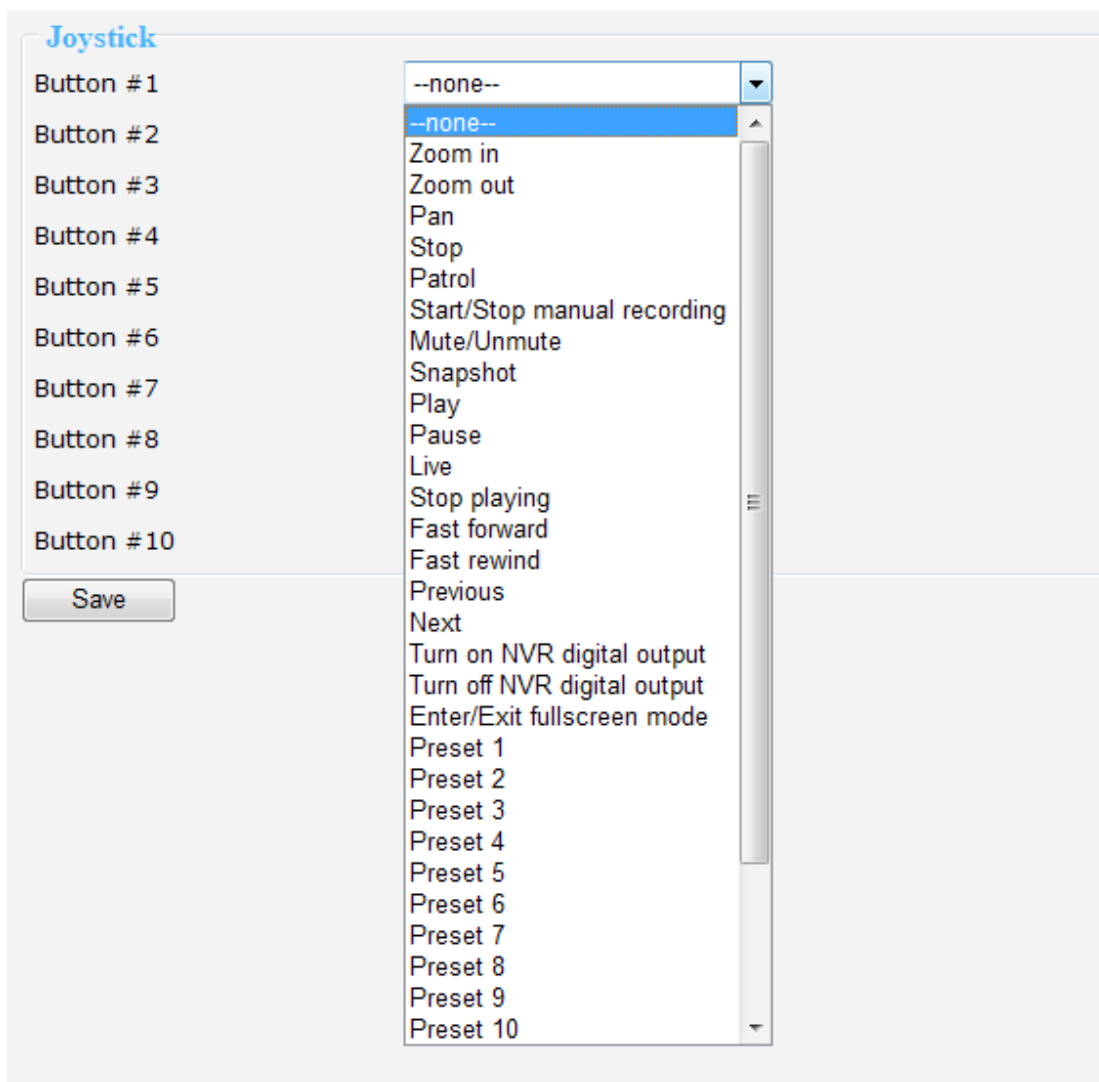

# Monitor

This page allows user to see the live view or playback recorded video from linked devices.

## User Interface of Monitor Page

Click **Monitor** on the Main Menu, the user interface of Monitor page will be displayed.

■ Following is the Monitor page (NR8301) without connected cameras.

**f**

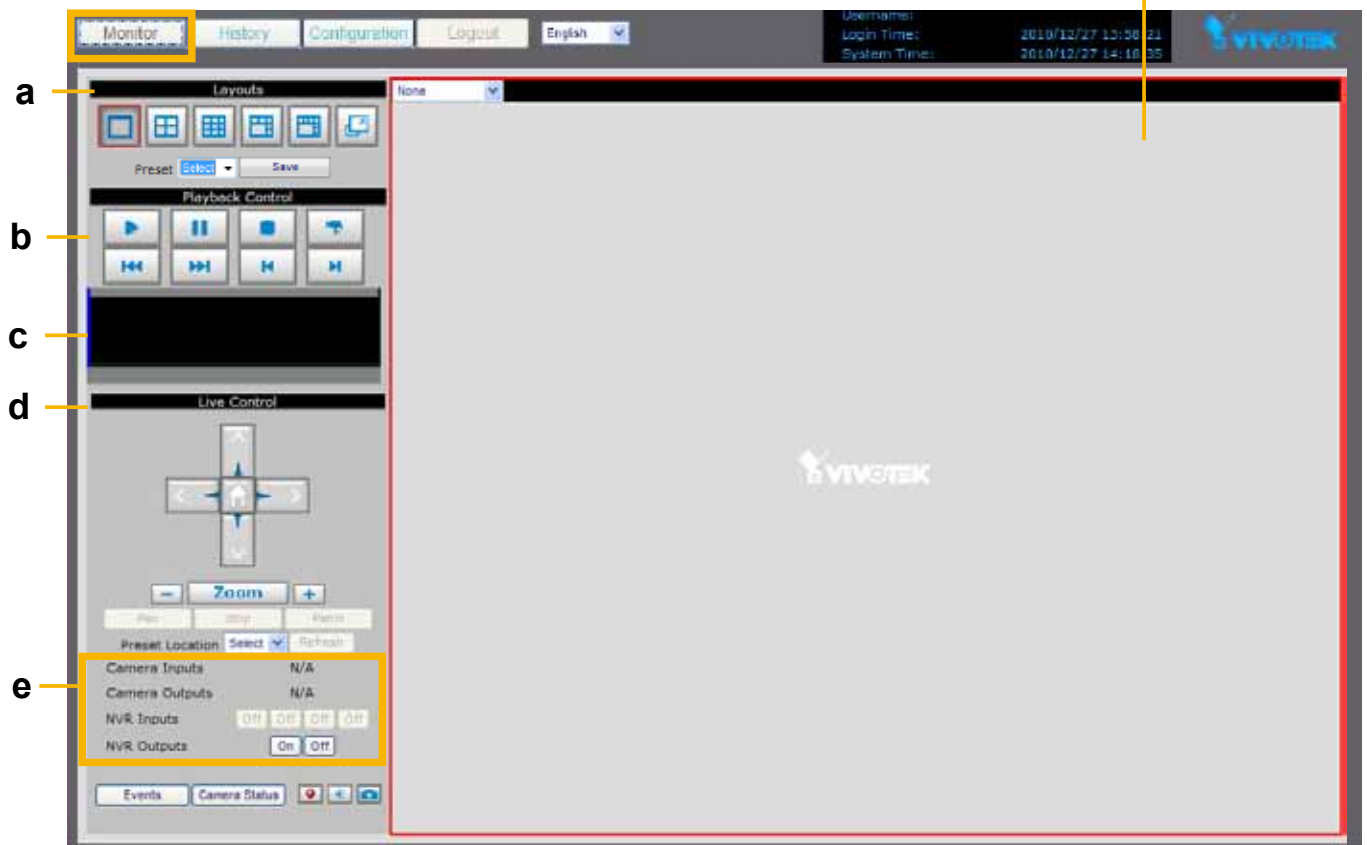

**a. Layouts**

**c. Time Bar and Histogram**

**e. Digital I/O Control Area**

**b. Playback Control**

**d. Live Control Panel**

**f. Video Cell**

### **NOTE**

► There are only two layouts (1x1,2x2) provided in NR8201.

- Following pictures show the Monitor page with connected cameras. For more information about how to insert connected cameras, please refer to Device on page 19.

Live viewing mode



Playback mode

Click on the Histogram to switch to playback mode. The Live Control Panel will turn into Playback Control Panel as below. Click  on the Playback Control Panel, it will switch to live viewing mode.





## Functions of Monitor Page

### Layouts

Click the Layout buttons to change the viewing mode.

#### ■ NR8301

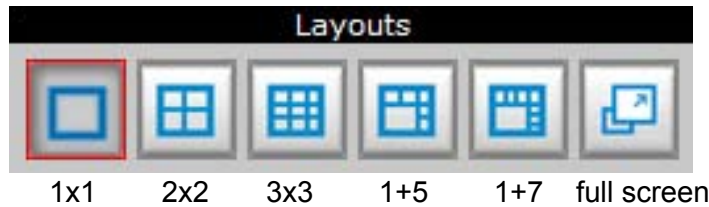

#### ■ NR8201

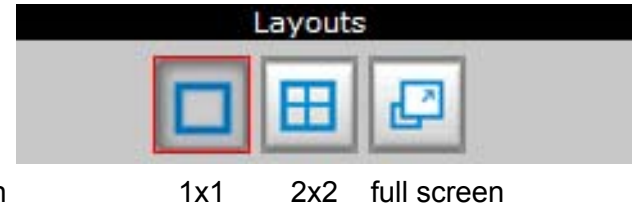

Following is an example of 4x4 layout. For each video cell, you can select a linked device on the drop-down list.

Drop-down list of Linked devices      The red frame represents the focused cell.

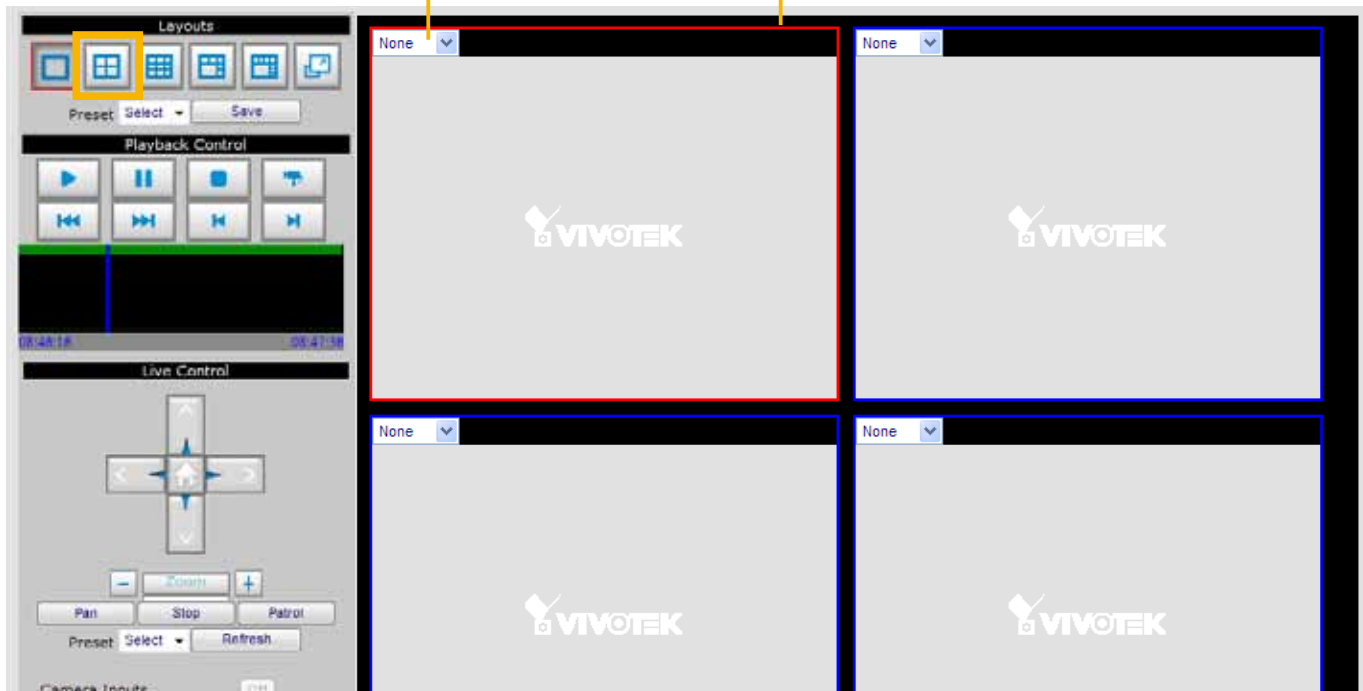

### Time Bar and Histogram

In the Monitoring page, the Histogram only shows video clip for 80 seconds as below. The blue line is the Time Bar. The green line is the status of motion value windows.

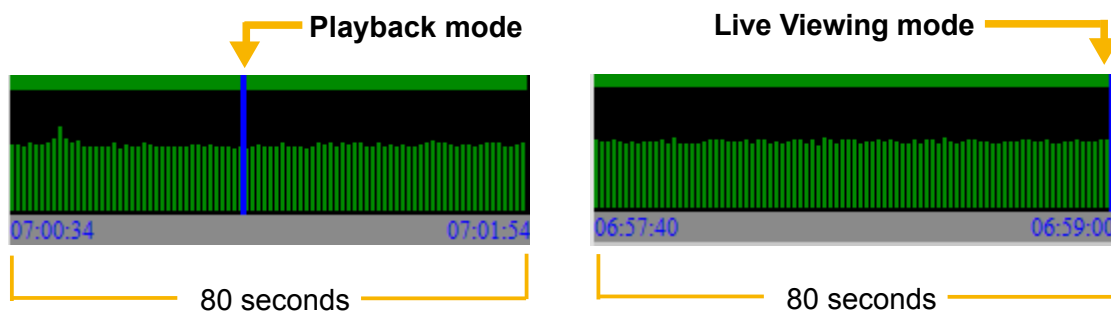

### Digital I/O Control Area

This column shows the DI status, and you can manually turn on/off the DO.

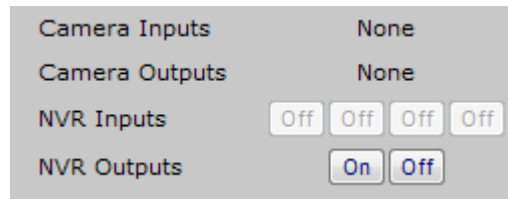

### Live Control Panel

Only PTZ and speed dome network cameras will enable the PTZ control panel.

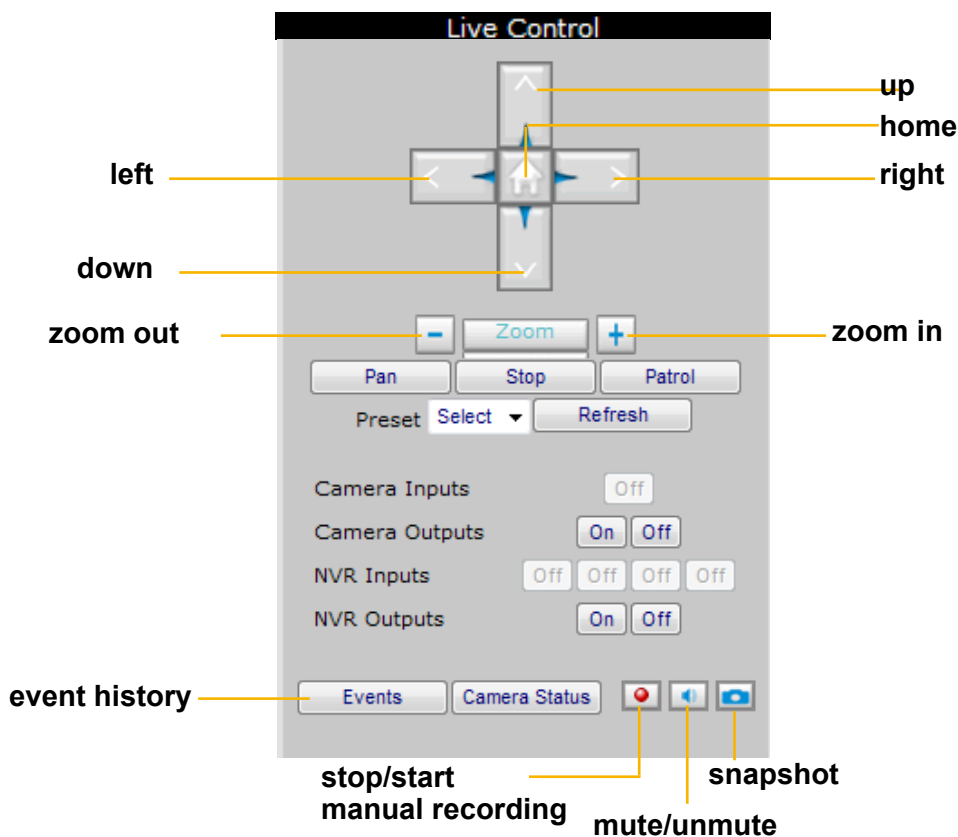

**Preset:** On the drop-down list, there are preset locations you've set on the Configuration page of the cameras.









**Refresh:** Click it to update the preset locations.

**Manual Recording Button:** If you click Manual Recording Button on the Live Control Panel, the Recording Type will turn into Manual recording. If you want to stop manual recording, click the button again.

**Snapshot:** Click to save a snapshot of the video you select. To configure **Snapshot and Download Path**, please refer to System on page 39.

## Playback Control Panel

There are eight buttons for you to playback the recorded video clips (current 80 seconds).

-  Play: To start or resume playback at normal speed.
-  Pause: To pause the playback. Click again to step forward a frame.
-  Stop: To stop video playback.
-  Live: To switch to live video.
-  Play rewind: To rewind recorded video. Click again to speed up (-4x, -16x, -64x).
-  Play forward: To playback recorded video. Click again to speed up (4x, 16x, 64x).
-  Previous: During playing mode, click this button to play the last video clip back in 60 seconds. During pause mode, click this button to step back to display the last I-frame.
-  Next: During playing mode, click this button to play the next video clip forward in 60 seconds. During pause mode, click this button to step back to display the next I-frame.

## Event Trigger Alarm

an exclamation mark



If you have set up an event for a device, an exclamation mark will flash on the upper right corner of the video cell when an event is triggered.

# History

This page offers user a time-navigation interface to playback recorded video and browse the live view from linked devices.

## User Interface of History Page

Click **History** on the Main Menu, the user interface of History page will be displayed as below:

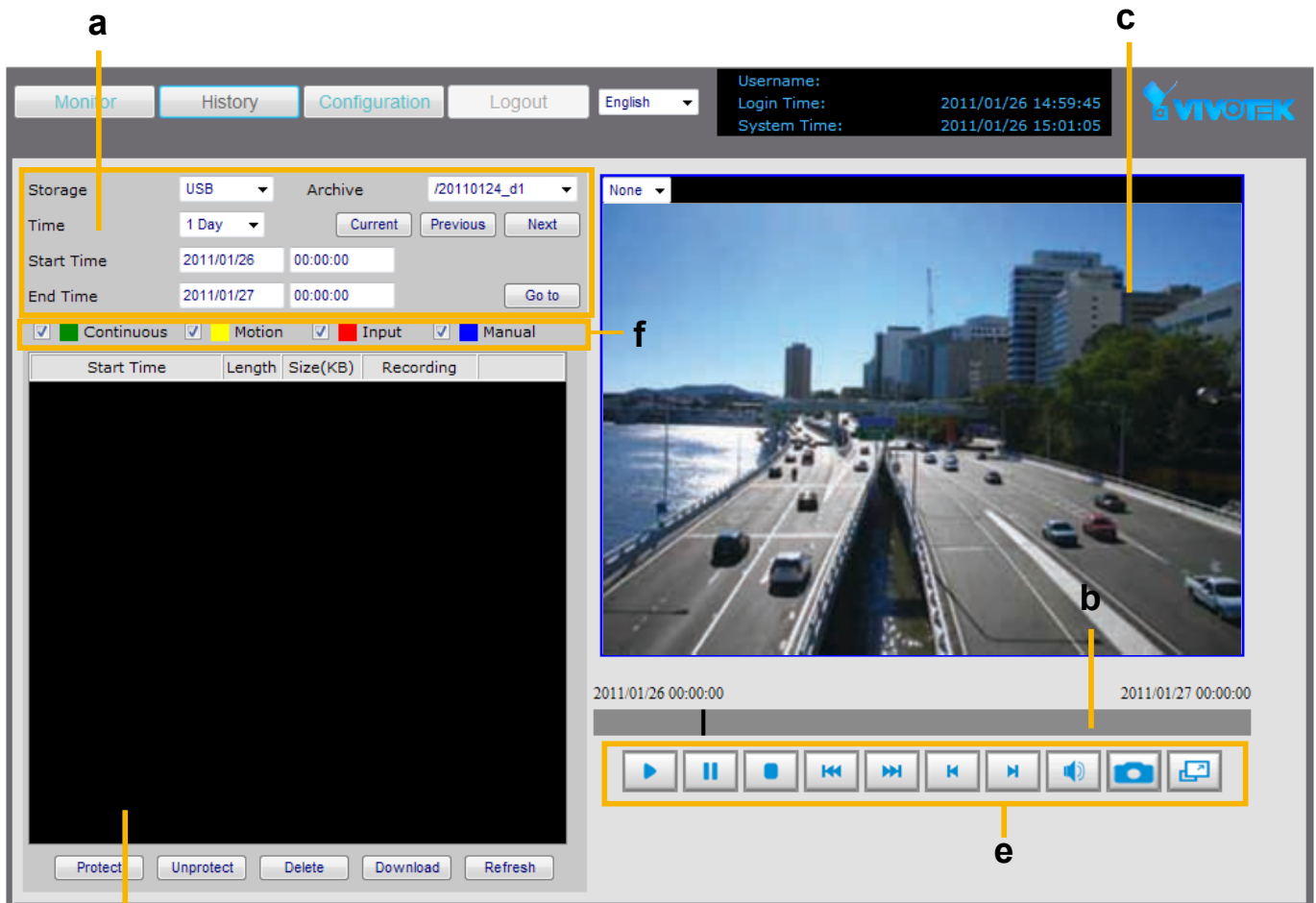

d

- a. Time Picker
- c. Recorded Video Clips
- e. Playback Control Panel

- b. Time Bar and Histogram
- d. Video Viewing Window
- f. Recording Mode

## Functions of History Page

### Time Picker

**Storage:** Select a storage device you want to review.

**Select Time:** Select a period of time (1 Hour, Day, 1 Week, 1 Month, or Manually), which decides the length of histogram.

**Start Time:** The beginning of the selected period of time.

**End Time:** The end of the selected period of time.

**Current** : Click this button to go to the current period of time (current Hour, Day, Week, or Month).

**Previous** : Click this button to go the last period of time (last Hour, Day, Week, or Month).

**Next** : Click this button to go the next period of time (next Hour, Day, Week, or Month).

**Go to** : Manually input the time, and then click this button to go the selected period of time (selected Hour, Day, Week, or Month).

### Time Bar and Histogram / Recorded Video Clips

The recorded video clips in the selected period of time will show up on the histogram and be listed in the recorded video clips window. In the following histogram, all recorded video clips are based on **Continuous recording** (green bar). The black Time Bar refers to the current time.

#### Continuous recording

Time	Duration	File Size	Recording Type	Audio Icon
2011/01/26 16:41:20	02'38"	151756	Continuous	Speaker icon
2011/01/26 16:43:59	02'38"	151992	Continuous	Speaker icon
2011/01/26 16:46:37	02'38"	152791	Continuous	Speaker icon
2011/01/26 16:49:16	02'38"	153566	Continuous	Speaker icon
2011/01/26 16:51:55	02'38"	152692	Continuous	Speaker icon
2011/01/26 16:54:34	02'38"	152487	Continuous	Speaker icon

 : The latest video clip, and still recording.

 : The video with recorded audio. To enable the audio function, please go to **Configuration > Device** to enable the Audio Compression setting of the Device.









: If you want to prevent a video clip from being erased by the latest video clip, select the video clip and then click this button. A Protect Icon  will show up.

: Select a video clip with Protect Icon and then click this button. Then the video clip becomes unprotected.

: If you want to delete a video clip, select it and then click this button.

: If you want to export an AVI file of a video clip to your local computer, select it and then click this button.

: Click this button to refresh the latest video clip.

Start Time	Length	Size(KB)	Recording	
2011/01/26 16:41:20	02'38"	151756	Continuous	
2011/01/26 16:43:59	02'38"	151992	Continuous	
2011/01/26 16:46:37	02'38"	152791	Continuous	
2011/01/26 16:49:16	02'38"	153566	Continuous	
2011/01/26 16:51:55	02'38"	152692	Continuous	
2011/01/26 16:54:34	02'38"	152487	Continuous	
2011/01/26 16:57:12	02'38"	152925	Continuous	
2011/01/26 16:59:51	00'42"	40440	Continuous	

## Recording Type

The following color bar will show up on the histogram according to the recording type.

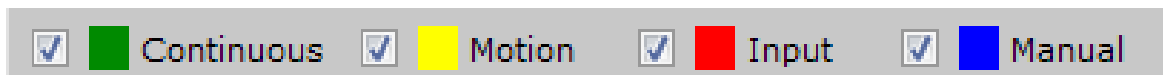

- Green bar (Continuous): Record video according to continuous mode. For detailed configuration, refer to **Recording Policy** on page 32.
- Yellow bar (Motion): Record video when motion triggers on linked device. For detailed configuration, please refer to **Recording Policy** on page 32.
- Red bar (Input): Record video when an external digital input triggers on linked cameras or on the Network Video Recorder. For detailed configuration, please refer to **Recording Policy** on page 32.
- Blue bar (Manual): Record video when the user starts manual recording. Please refer to Manual Recording on page 50 for detailed information.

Example:  
 Following video clip list contains different kinds of recording mode.

The screenshot displays a video management interface. On the left, there is a configuration panel with the following settings:

- Storage: Internal
- Time: 1 Hour
- Start Time: 2011/01/26 17:00:00
- End Time: 2011/01/26 18:00:00
- Recording Modes:  Continuous,  Motion,  Input,  Manual

Below the configuration is a table of recording clips:

Start Time	Length	Size(KB)	Recording	
2011/01/26 16:59:51	02'38"	152367	Continuous	
2011/01/26 17:02:30	02'38"	152374	Continuous	
2011/01/26 17:05:09	02'38"	152224	Continuous	
2011/01/26 17:07:47	02'38"	153462	Continuous	
2011/01/26 17:10:26	02'38"	164171	Continuous	
2011/01/26 17:13:05	02'16"	140332	Continuous	
2011/01/26 17:24:59	02'39"	154686	Continuous	
2011/01/26 17:27:38	01'54"	117978	Continuous	
2011/01/26 17:29:50	00'47"	48402	Motion	
2011/01/26 17:30:44	02'39"	164336	Motion	
2011/01/26 17:33:24	00'18"	20157	Motion	

At the bottom of the table are buttons: Protect, Unprotect, Delete, Download, Refresh.

On the right, a video player shows a live feed from camera IP8162. The player includes a timeline from 2011/01/26 17:00:00 to 2011/01/26 18:00:00 with colored segments (green, yellow, red) corresponding to the recording modes in the table. Below the timeline are playback controls: Play, Pause, Stop, Previous, Next, Full Screen, and a volume icon.

**NOTE**

► For the length of Continuous Recording, Motion Recording, Input Recording, and Manual Recording, please refer to **Recording Policy** on page 32 for detailed configuration.

- There are two ways to playback recorded video clips:
  1. Click a desired time on the histogram.

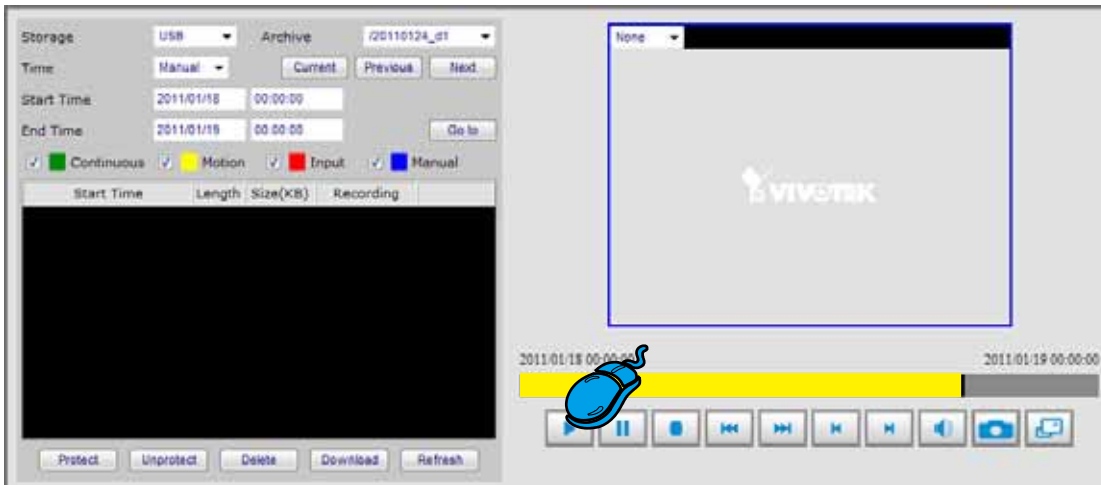



2. Click on a video clip, and then click  on the playback control panel.









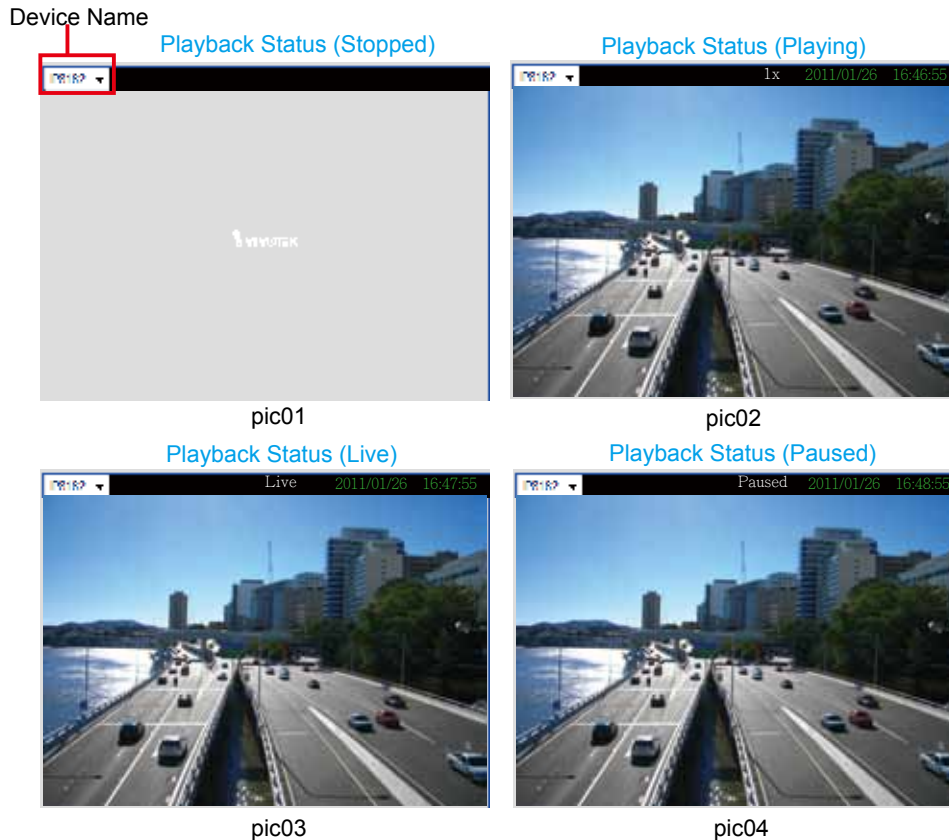





## Video Viewing Window

This window playbacks the recorded videos. If you have not selected a video, the playback status will be empty as pic01. Once you select a video clip to play, the video viewing window will begin to playback the selected recorded video clips as pic02. If you click  on the playback control panel, the video viewing window will switch to the live video view as pic03. If you click , the video will paused as pic04.



## Playback Control Panel

There are eight buttons for you to playback the recorded video clips.

-  Play: To start or resume playback at normal speed.
-  Pause: To pause the playback. Click again to step forward a frame.
-  Stop: To stop video playback.
-  Play rewind: To rewind recorded video. Click again to speed up (-4x, -16x, -64x).
-  Play forward: To playback recorded video. Click again to speed up (4x, 16x, 64x).
-  Previous: During playing mode, click this button to move to play the last video clip.  
During pause mode, click this button to step back to display the last I-frame.
-  Next: During playing mode, click this button to move to play the next video clip.  
During pause mode, click this button to step back to display the next I-frame.
-  Mute/Unmute: To mute / unmute the audio of the video files.
-  Snapshot: To snapshot the image of the moment and save it in the designed path.
-  Full screen: To enlarge the live view window to full fill the browser window.

# Appendix

## Technical Specifications

<b>System</b> <ul style="list-style-type: none"> <li>· CPU: Marvell 88F6281 1.2G</li> <li>· Flash: 128MB</li> <li>· RAM: DDR-SRAM 512MB</li> <li>· Embedded OS: Linux</li> </ul>	<b>Alarm and Event Management</b> <ul style="list-style-type: none"> <li>· Four D/I and one D/O for external sensor and alarm</li> <li>· Event notification using SMTP</li> </ul>
<b>Channels</b> <ul style="list-style-type: none"> <li>· NR8201: Support up to 4 channels</li> <li>· NR8301: Support up to 8 channels</li> </ul>	<b>Security</b> <ul style="list-style-type: none"> <li>· Multi-level user access with password protection</li> <li>· IP address filtering</li> </ul>
<b>Hard Disk</b> <ul style="list-style-type: none"> <li>· NR8201: Support 1 x 3.5" SATA I/II HDD, up to 2TB (Support external eSATA interface)</li> <li>· NR8301: Support 2 x 3.5" SATA I/II HDD, up to 4TB (Support RAID 0, 1 scalable storage)</li> </ul>	<b>Users</b> <ul style="list-style-type: none"> <li>· Camera live and playback viewing for up to 10 clients</li> </ul>
<b>Compatibility</b> <ul style="list-style-type: none"> <li>· Support VIVOTEK all series of network cameras</li> </ul>	<b>Dimension</b> <ul style="list-style-type: none"> <li>· 446.4 mm (W) x 330.2 mm (D) x 43.6 mm (H)</li> </ul>
<b>Codec</b> <ul style="list-style-type: none"> <li>· Video compression: H.264/MJPEG/MPEG-4</li> <li>· Audio compression: AAC/GAMR/G.711</li> </ul>	<b>Weight</b> <ul style="list-style-type: none"> <li>· NR8201: 4kg</li> <li>· NR8301: 4.7kg</li> </ul>
<b>Recording Throughput</b> <ul style="list-style-type: none"> <li>· Total 50Mbps</li> <li>· NR8201: 4 x 30fps @ 1080P</li> <li>· NR8301: 8 x 30fps @ 1280x800</li> </ul>	<b>LED Indicator</b> <ul style="list-style-type: none"> <li>· System power, PoE, status and hard disk indicators</li> <li>· Network link indicator</li> </ul>
<b>Recording Policy</b> <ul style="list-style-type: none"> <li>· Alarm recording</li> <li>· Scheduled recording</li> <li>· Continuous recording</li> <li>· Manual recording</li> </ul>	<b>Power</b> <ul style="list-style-type: none"> <li>· 100 ~ 240V AC</li> <li>· 802.3af compliant Power-over-Ethernet</li> <li>· Power consumption: NR8201: Max. 0.48 W (without PoE camera); Max. 60 W (with 4 PoE cameras) NR8301: Max. 0.96 W (without PoE camera); Max. 120 W (with 8 PoE cameras)</li> </ul>
<b>Connectors</b> <ul style="list-style-type: none"> <li>· 1 x Gigabit, RJ45 ( 1 WAN port )</li> <li>· NR8201: 4 x Ethernet 10/100 BaseT, RJ45 ( 4 LAN ports)</li> <li>· NR8301: 8 x Ethernet 10/100 BaseT, RJ45 ( 8 LAN ports)</li> <li>· USB socket for backup</li> <li>· Terminal block: 4 digital input, 1 relay output, and 1 power output with 12V Max. 1A</li> </ul>	<b>Approvals</b> <ul style="list-style-type: none"> <li>· CE, FCC, VCCI, C-Tick, CB</li> </ul>
<b>Camera Management</b> <ul style="list-style-type: none"> <li>· Auto or manual installation for VIVOTEK cameras</li> <li>· Video and network configuration through NR8301</li> </ul>	<b>Operating Environments</b> <ul style="list-style-type: none"> <li>· Temperature: 0 ~ 50 °C (32 ~ 122 °F)</li> <li>· Humidity: 20% ~ 80% RH</li> </ul>
<b>Pan/Tilt/Zoom Control</b> <ul style="list-style-type: none"> <li>· Pan/tilt/zoom control of VIVOTEK cameras</li> </ul>	<b>Viewing System Requirements</b> <ul style="list-style-type: none"> <li>· OS: Microsoft Windows 2000/XP/Vista/Win7</li> <li>· Browser: Internet Explorer 6 or above</li> <li>· 3GPP access</li> </ul>
<b>History Playback</b> <ul style="list-style-type: none"> <li>· Playback of recorded media with time navigations</li> </ul>	<b>Installation, Management and Maintenance</b> <ul style="list-style-type: none"> <li>· VAST central management software</li> <li>· Installation Wizard 2</li> <li>· Support firmware upgrade</li> <li>· Support VIVOTEK joystick</li> </ul>
<b>Networking</b> <ul style="list-style-type: none"> <li>· Protocols: IPv4, TCP/IP, HTTP, RTSP/RTP/RTCP, IGMP, SMTP,FTP, DHCP, NTP, DNS, DDNS, 3GPP</li> </ul>	<b>Warranty</b> <ul style="list-style-type: none"> <li>· 24 months</li> </ul>

All specifications are subject to change without notice. Copyright ©2011 VIVOTEK INC. All rights reserved.

## URL Commands for the Network Camera

### RTSP URL command

RTSP://ip\_address[:port]/cameraID

where camera ID is mac address with 00,

For instance, if mac is 00:02:dd:dd:dd:dd the camera ID is 0002ddddddd00

url example is RTSP://192.168.100.1/0002ddddddd00