

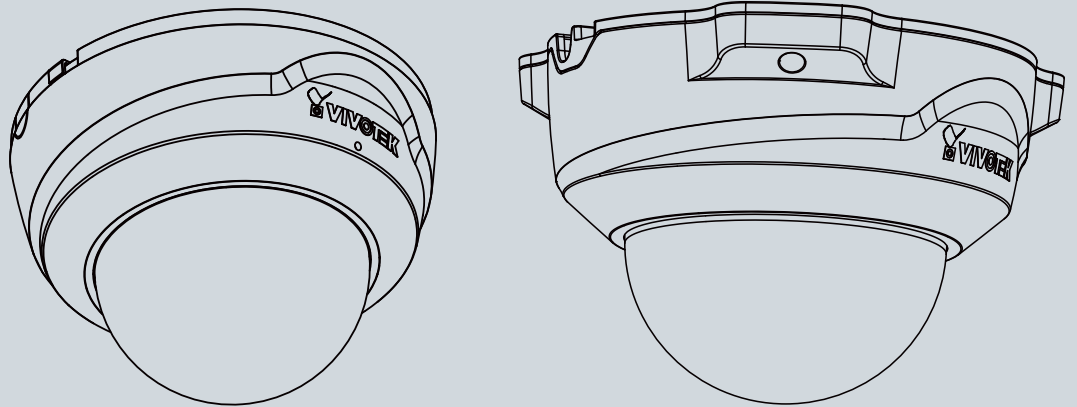

# FD8137H/8137HV Fixed Dome Network Camera User's Manual

1MP • H.264 • MicroSD/SDHC/SDXC • Compact Design



Rev. 1.1

## ***Table of Contents***

---

<b>Overview</b> .....	<b>4</b>
Revision History .....	4
Read Before Use .....	5
Package Contents .....	5
Symbols and Statements in this Document .....	5
<b>Hardware Installation - FD8137H</b> .....	<b>6</b>
Physical Description .....	6
Installation .....	8
Network Deployment .....	10
<b>Hardware Installation - FD8137HV</b> .....	<b>11</b>
Software Installation .....	16
Ready to Use .....	17
Completion .....	18
<b>Accessing the Network Camera</b> .....	<b>19</b>
Using Web Browsers .....	19
Using RTSP Players .....	22
Using 3GPP-compatible Mobile Devices .....	23
Using VIVOTEK Recording Software .....	24
<b>Main Page</b> .....	<b>25</b>
<b>Go to</b> .....	<b>28</b>
<b>Client Settings</b> .....	<b>30</b>
<b>Configuration</b> .....	<b>34</b>
System > General settings .....	35
System > Homepage layout .....	37
System > Logs .....	40
System > Parameters .....	42
System > Maintenance .....	43
Media > Image .....	47
Media > Video .....	54
Media > Video .....	55
Media > Audio .....	59
Network > General settings .....	60
Network > Streaming protocols .....	67
Network > SNMP (Simple Network Management Protocol) .....	76
Security > User accounts .....	77
Security > HTTPS (Hypertext Transfer Protocol over SSL) .....	78
Security > Access List .....	85
PTZ > PTZ settings .....	90
Event > Event settings .....	94
Applications > Motion detection .....	107
Applications > Digital input .....	110
Applications > Tampering detection .....	110
Applications > VADP (VIVOTEK Application Development Platform (FD8137H Series)) .....	111
Recording > Recording settings .....	113

Local storage > SD card management.....	118
Local storage > Content management.....	119
Appendix .....	122
URL Commands for the Network Camera.....	122
Technical Specifications .....	194
Technology License Notice.....	195
Electromagnetic Compatibility (EMC).....	196

# Overview

VIVOTEK FD8137H/8137HV is an easy-to-use fixed dome network camera specifically designed for indoor/outdoor security applications with a compact, stylish vandal-proof exterior. It features a HD WDR CMOS sensor to cope with challenging lighting conditions. The WDR Pro Technology allows the camera to capture both dark and bright parts of an image and combines the differences to generate a highly realistic image representative of the original scene, enabling it to provide video quality close to the capabilities of the human eye. This function enables the FD8137H series to be widely applicable in high contrast environments such as lobby entrances, parking lots, ATMs, loading areas, and much more.

In order to adapt to constantly changing outdoor lighting conditions, the FD8137H series features a removable IR-cut filter as well as improved IR illuminators effective up to 15M for superior image quality around the clock.

For protection against harsh outdoor environments, the FD8137HV is encased in an IP66-rated housing to withstand rain and dust. Furthermore, the metal vandal-proof housing effectively provides robust protection from vandalism.

The FD8137H series supports the industry-standard H.264 compression technology, drastically reducing file sizes and conserving valuable network bandwidth. With H.264, and MJPEG compatibility both included, the dual streams can be simultaneously transmitted in any of these formats at different resolutions, frame rates, and image qualities for versatile platforms. Thereby it further optimizes bandwidth and storage efficiency.

Incorporating a number of advanced features standard for VIVOTEK cameras, including tamper detection, 802.3af compliant PoE, MicroSD/SDHC/SDXC card slot, and VIVOTEK's 32-channel recording software, the FD8137H series is the ideal solution for your indoor/outdoor surveillance needs.

## Revision History

- Rev. 1.0: Initial release.
- Rev. 1.1: The later revision of firmware, 0101a, supports the 3D Noise Reduction configuration.



## Read Before Use

The use of surveillance devices may be prohibited by law in your country. The Network Camera is not only a high-performance web-ready camera but can also be part of a flexible surveillance system. It is the user's responsibility to ensure that the operation of such devices is legal before installing this unit for its intended use.

It is important to first verify that all contents received are complete according to the Package Contents listed below. Take note of the warnings in the Quick Installation Guide before the Network Camera is installed; then carefully read and follow the instructions in the Installation chapter to avoid damage due to faulty assembly and installation. This also ensures the product is used properly as intended.

The Network Camera is a network device and its use should be straightforward for those who have basic networking knowledge. It is designed for various applications including video sharing, general security/surveillance, etc. The Configuration chapter suggests ways to best utilize the Network Camera and ensure proper operations. For creative and professional developers, the URL Commands of the Network Camera section serves as a helpful reference to customizing existing homepages or integrating with the current web server.

## Package Contents

- FD8137H / FD8137HV
- Screws / cable tie (indoor)/ Terminal block plug-in / Waterproof connector (outdoor)
- Software CD
- Quick Installation Guide
- Alignment sticker

## Symbols and Statements in this Document



**INFORMATION:** provides important messages or advices that might help prevent inconvenient or problem situations.



**NOTE:** Notices provide guidance or advices that are related to the functional integrity of the machine.



**Tips:** Tips are useful information that helps enhance or facilitate an installation, function, or process.



**WARNING! or IMPORTANT!:** These statements indicate situations that can be dangerous or hazardous to the machine or you.



**Electrical Hazard:** This statement appears when high voltage electrical hazards might occur to an operator.

# Hardware Installation - FD8137H

## Physical Description

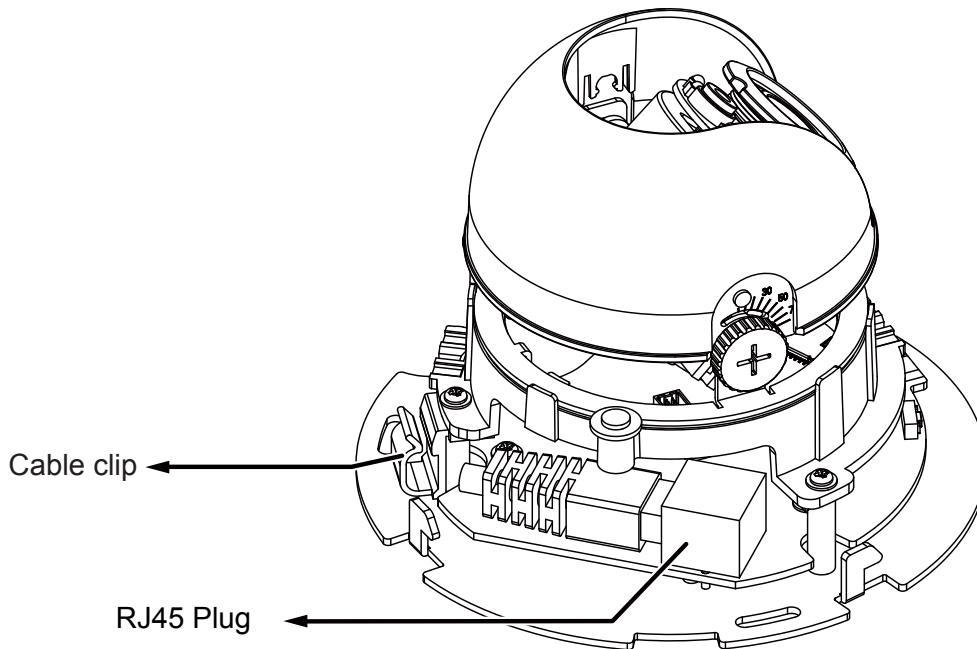
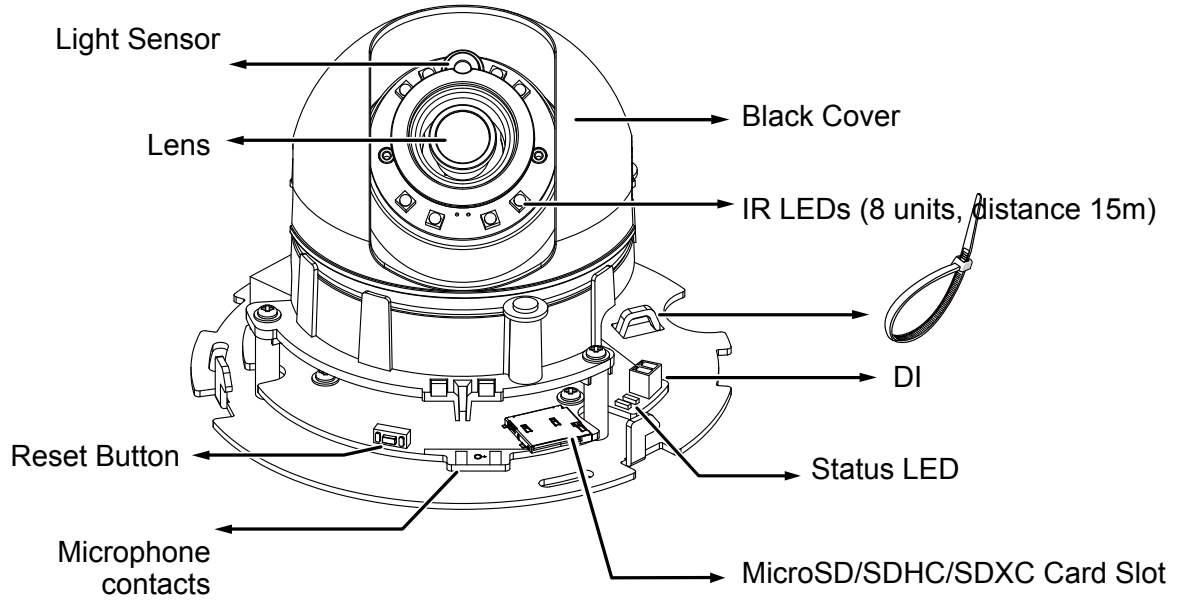

## General I/O Terminal Block

This Network Camera provides a general I/O terminal block which is used to connect external input / output devices. The pin definitions are described below. The 24V AC can be used as an alternate power source.

Pin	Name
+	Digital Input +
-	Digital Input -

## Hardware Reset

The reset button is used to reset the system or restore the factory default settings. Sometimes resetting the system can return the camera to normal operation. If the system problems remain after reset, restore the factory settings and install again.

**Reset:** Press and release the recessed reset button with a straightened paper clip. Wait for the Network Camera to reboot.

**Restore:** Press and hold the recessed reset button until the status LED rapidly blinks. Note that all settings will be restored to factory default. Upon successful restore, the status LED will blink green and red during normal operation.

## Micro SD/SDHC/SDXC Card Capacity

This network camera is compliant with **Micro SD/SDHC/SDXC 16GB / 8GB** and other preceding standard SD cards.

## Installation

### Removing Dome Cover

First, follow the instructions below to remove the dome cover. Flip the black retention tabs in the clockwise direction to release the dome cover (clockwise if you look from the bottom up.)

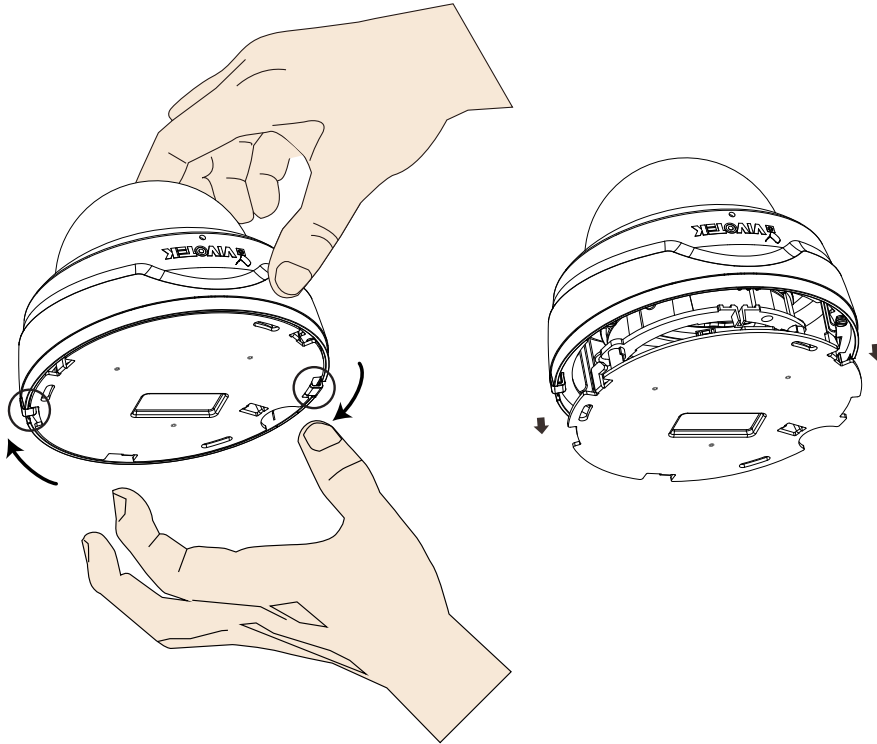

Then remove the black cover as shown below.

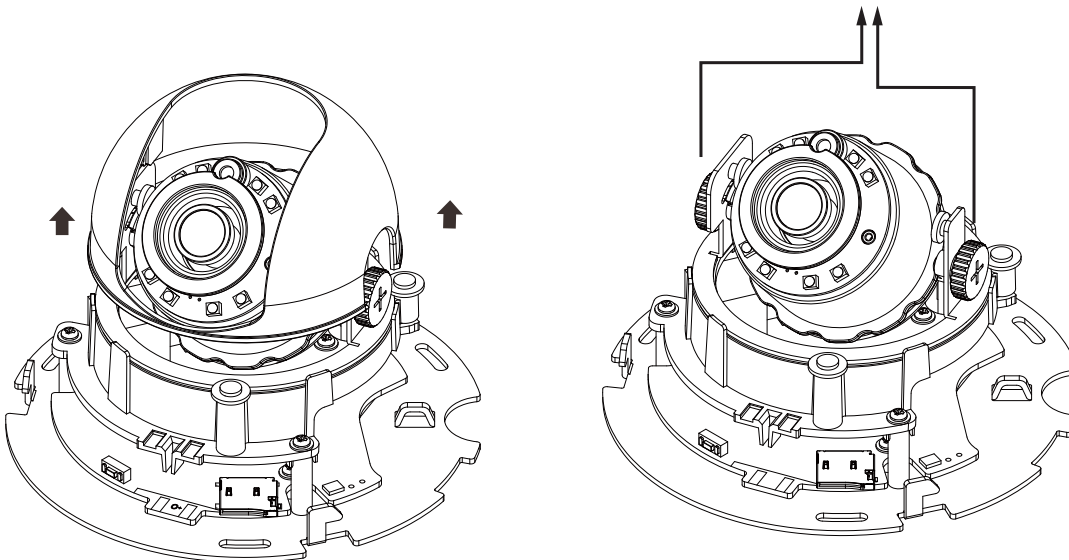

To install the camera to a ceiling or wall:

1. Attach the alignment sticker to the ceiling/wall.
2. Through the two circles on the sticker, drill two pilot holes into the ceiling/wall.
3. The Network Camera can be mounted with the cable routed through the ceiling/wall or from the side. If you want to feed the cable through the ceiling/wall, drill a cable hole A as shown in the above picture.
4. Hammer the supplied plastic anchors into the holes.
5. Secure the camera with the supplied screws.

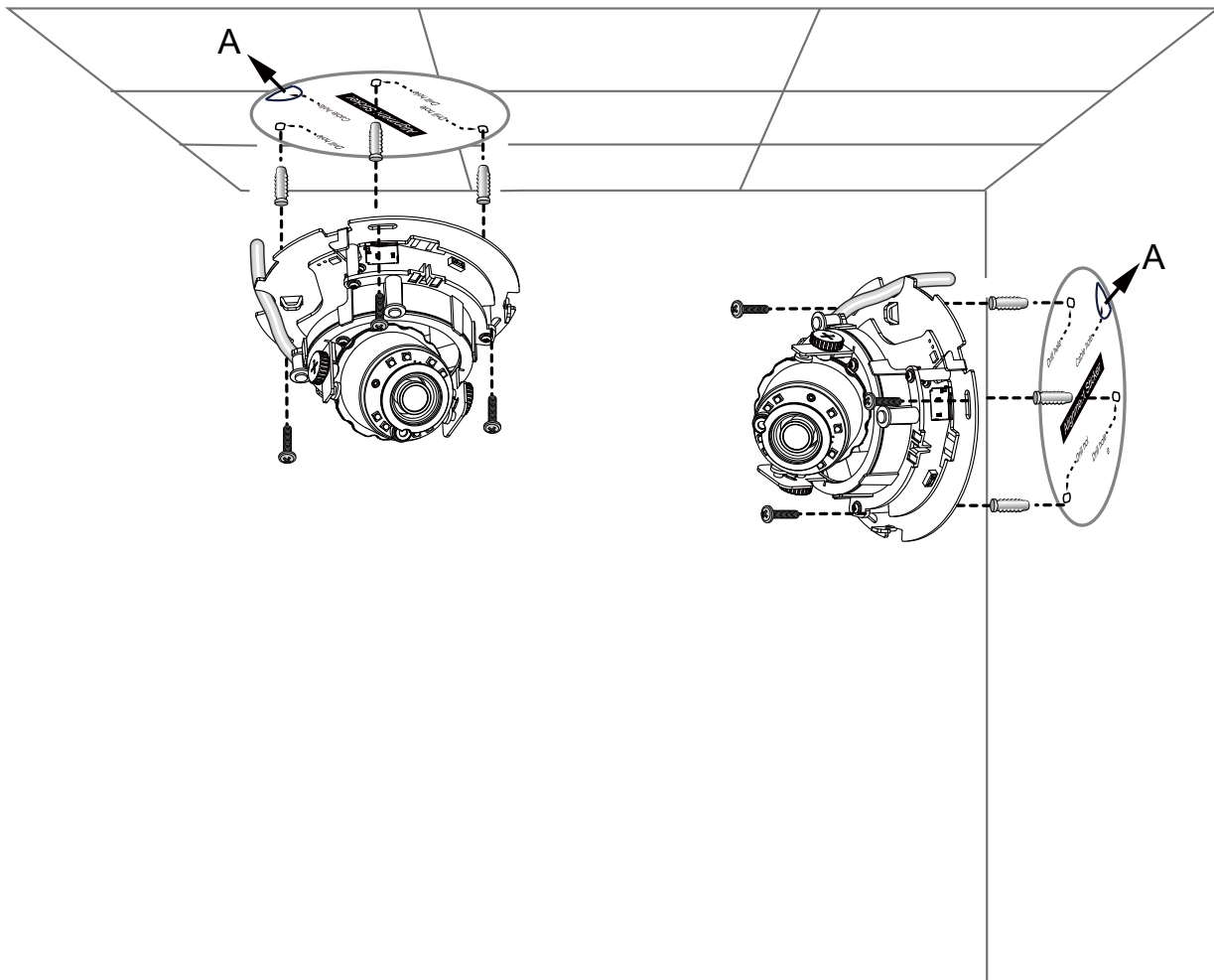

## Network Deployment

### Set up the Network Camera through Power over Ethernet (PoE)

#### When using a PoE-enabled switch

The Network Camera is PoE-compliant, allowing transmission of power and data via a single Ethernet cable. Follow the below illustration to connect the Network Camera to a PoE-enabled switch via Ethernet cable.

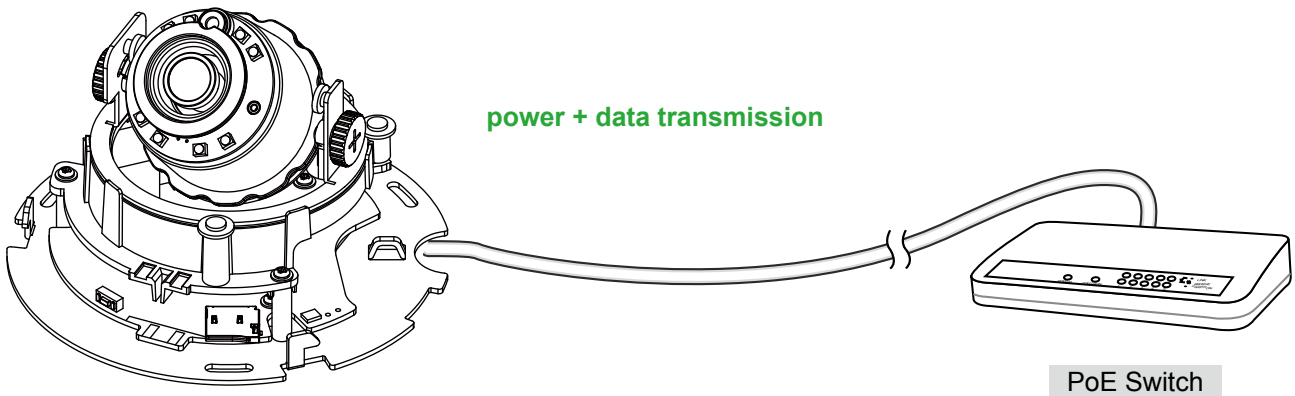

#### When using a non-PoE switch

If your switch/router does not support PoE, use a PoE power injector (optional) to connect between the Network Camera and a non-PoE switch.

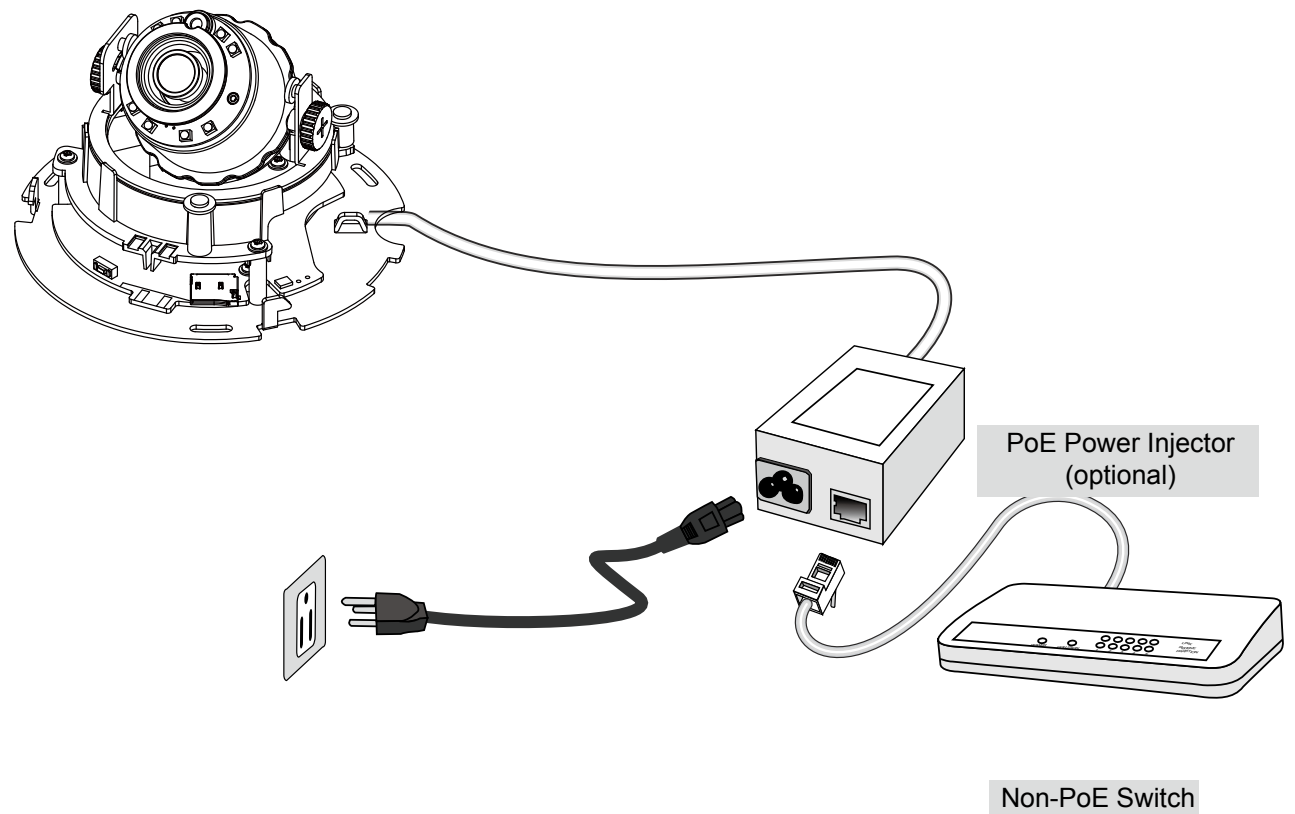

# Hardware Installtion - FD8137HV

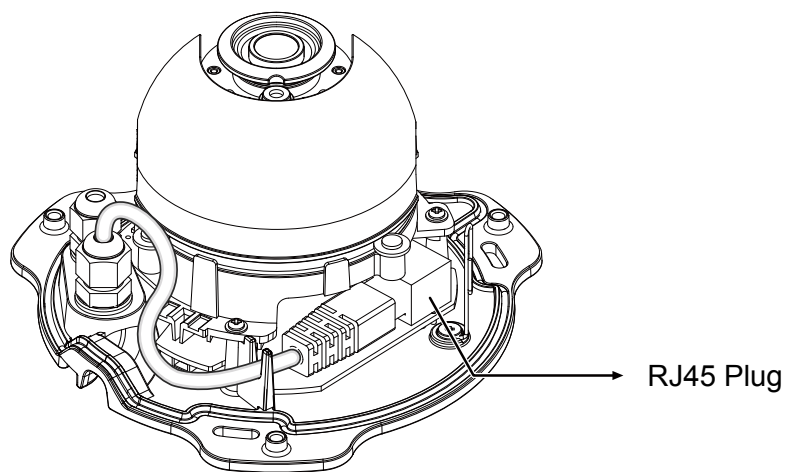
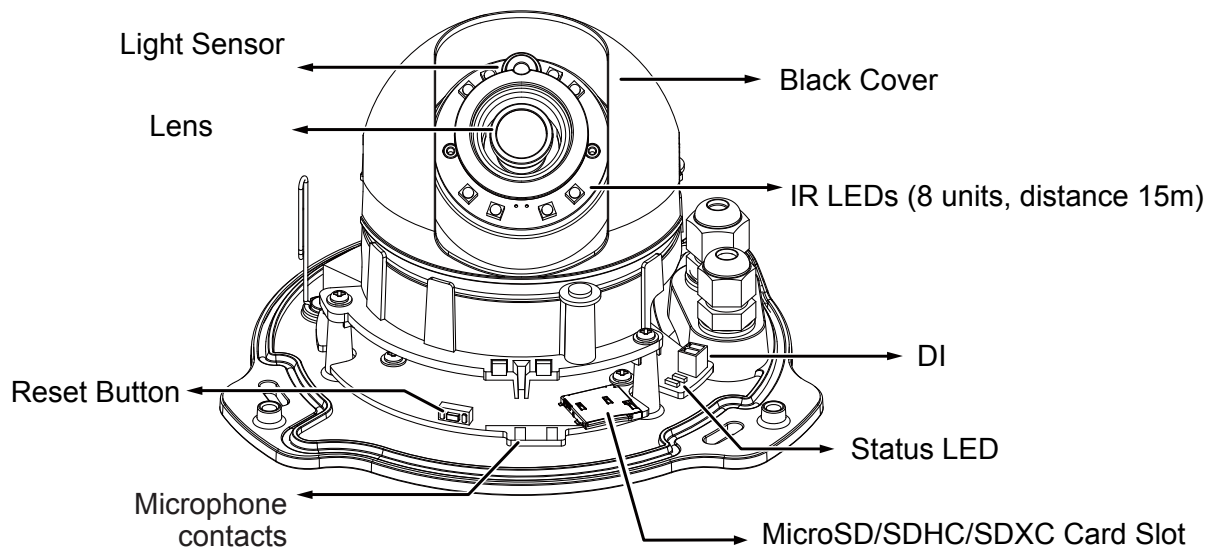

## Hardware Installation

1. Remove the dome cover.
2. Then remove the black cover as shown below.

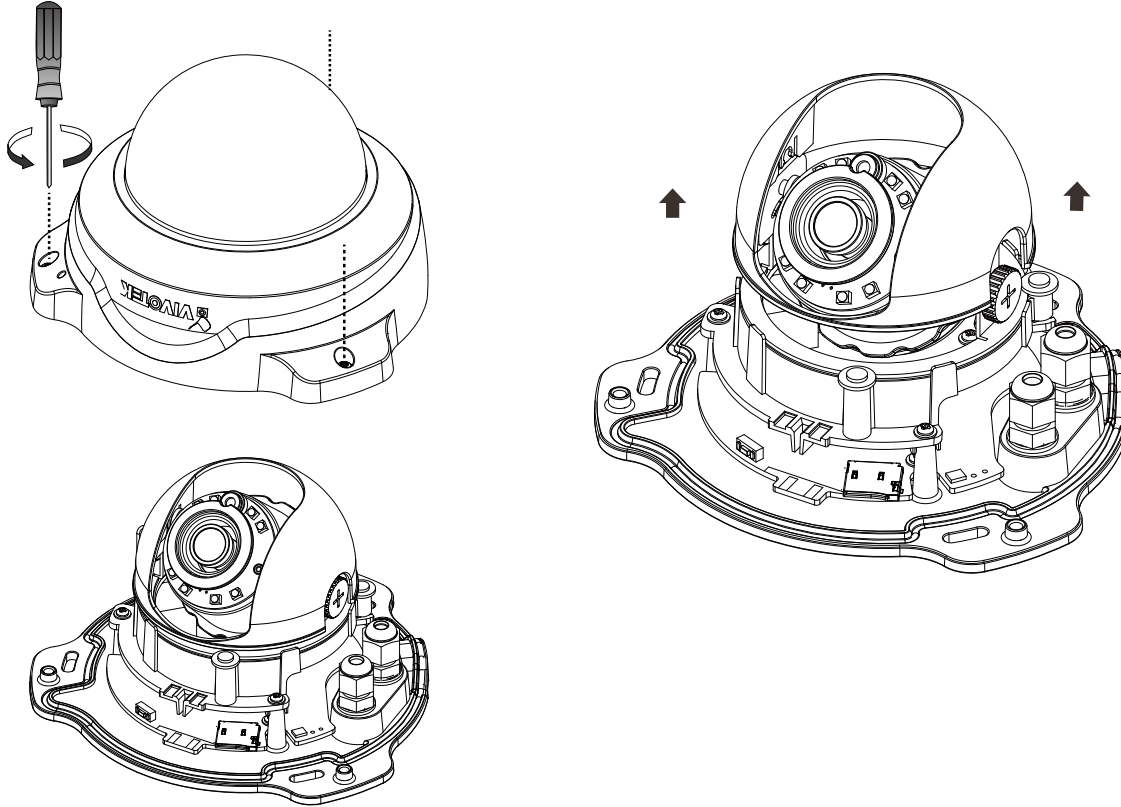

3. Pass Ethernet and DI wires through the rubber seals and the waterproof connectors.

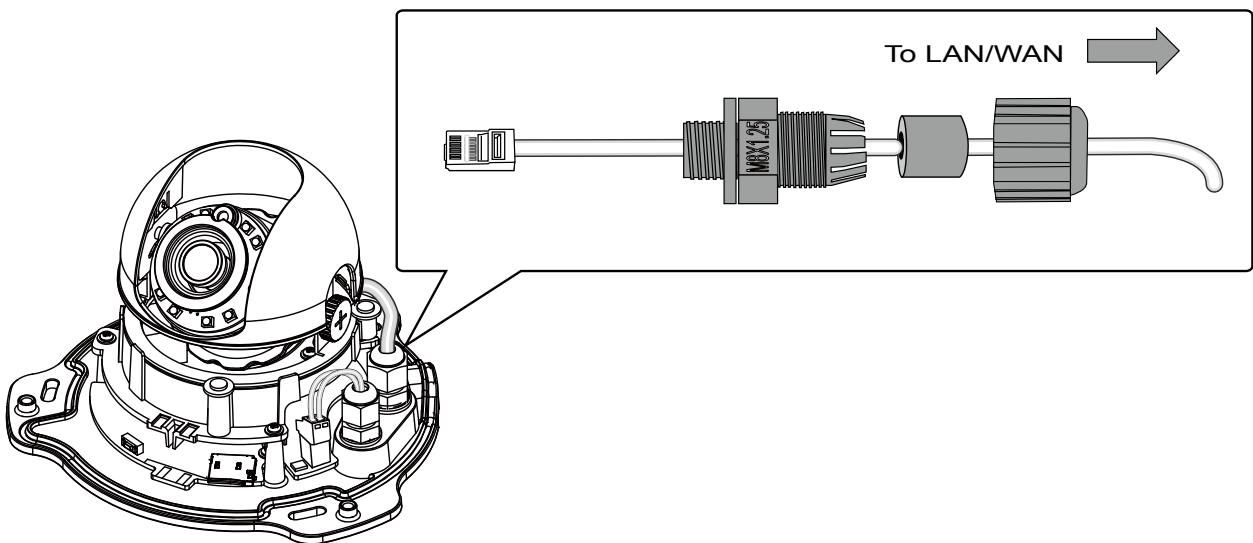

Cable gauge:  
 Ethernet: 5~6.3mm  
 DI: 1~2mm



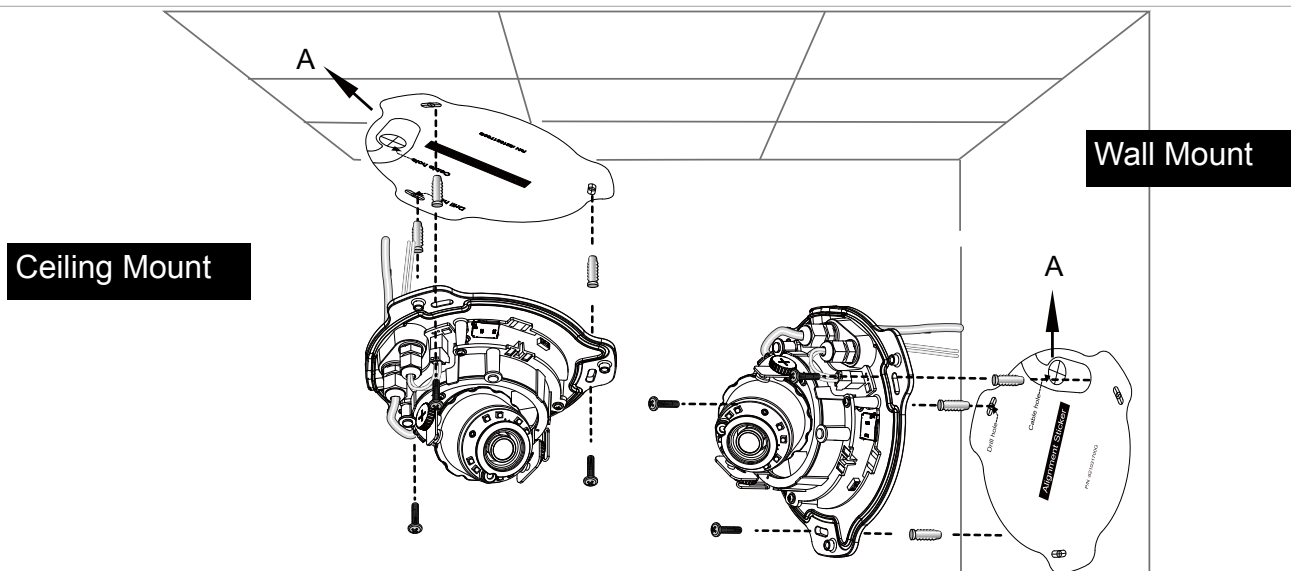

1. Attach the alignment sticker to the ceiling/wall.
2. Drill three pilot holes into the ceiling/wall.
3. If you want to feed the cable through the ceiling/wall, drill a cable hole A as shown in the above picture.
4. Hammer the supplied plastic anchors into the holes.
5. Secure the camera using the supplied screws.

### Adjusting the Lens

Adjust the camera lens to the desired viewing angle:

1. Loosen the tilt adjustment screws on both sides
2. Turns the lens modules toward the direction you prefer.
3. Tighten the adjustment screws.

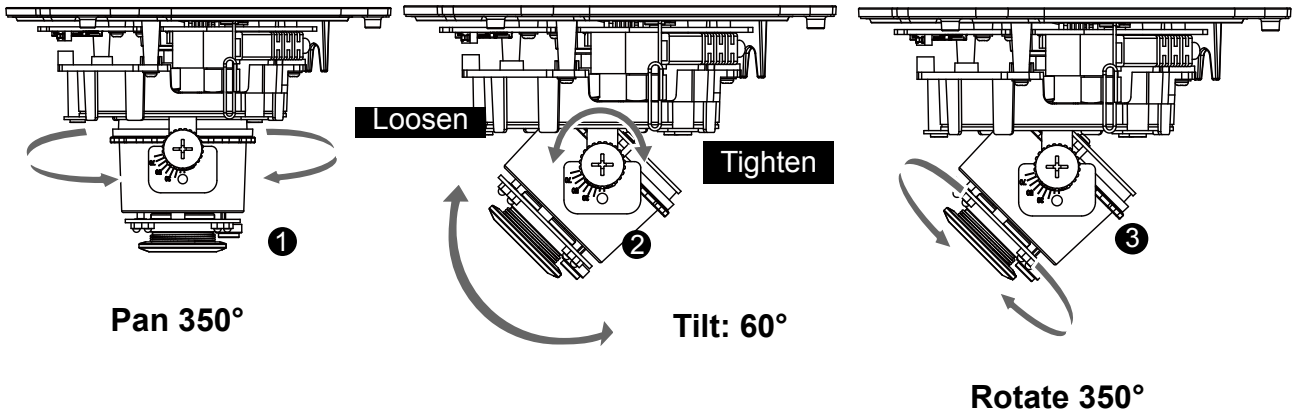

1. Attach the black cover. If you feed the cable from the side, route cables from the groove at the bottom.
2. Attach the dome cover.

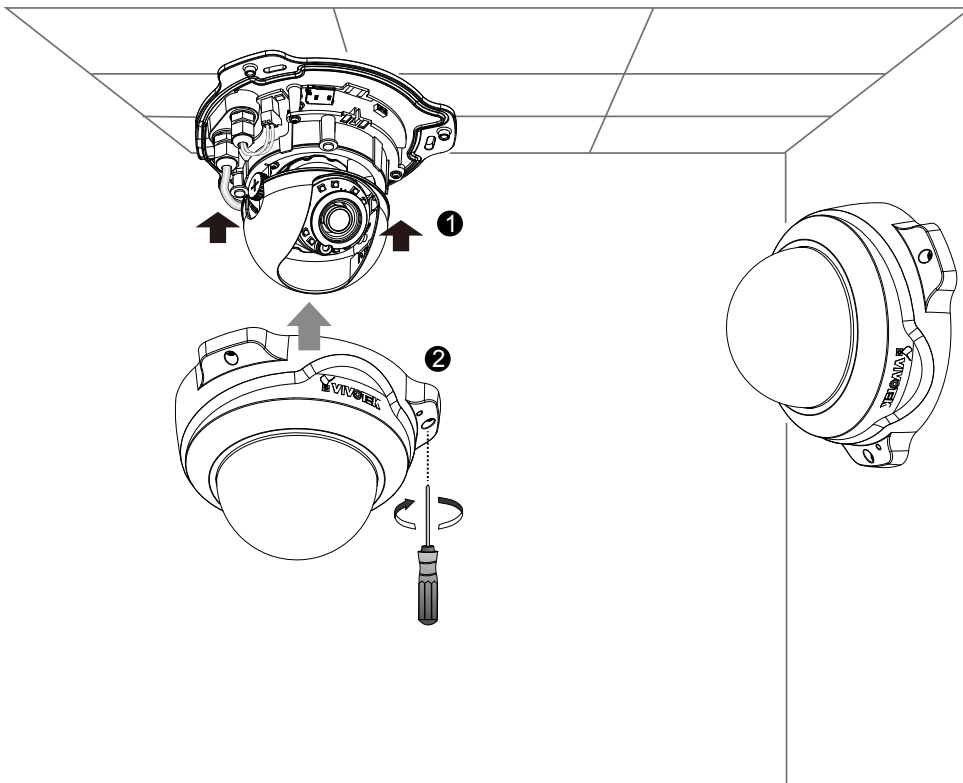

## Internet connection via a router

Before setting up the Network Camera over the Internet, make sure you have a router and follow the steps below.

1. Connect your Network Camera behind a router, the Internet environment is illustrated below. Regarding how to obtain your IP address, please refer to Software Installation on page 16 for details.

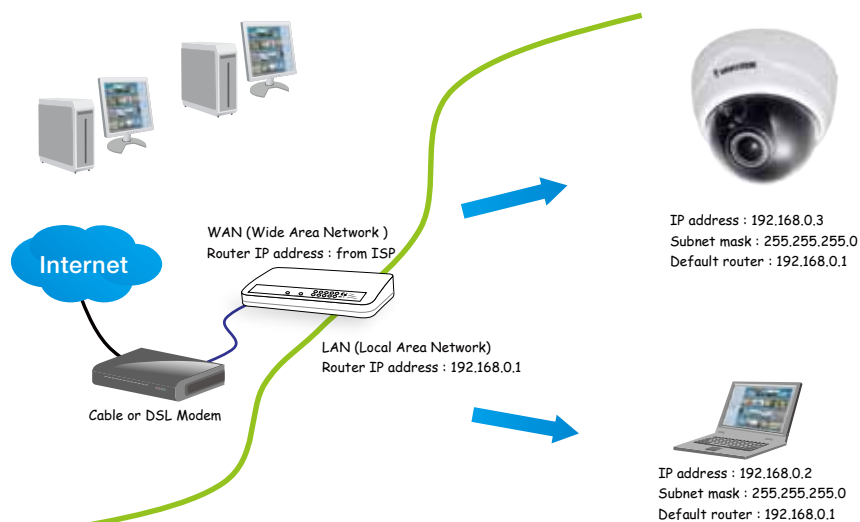

2. In this case, if the Local Area Network (LAN) IP address of your Network Camera is 192.168.0.3, please forward the following ports for the Network Camera on the router.

- HTTP port: default is 80
- RTSP port: default is 554
- RTP port for audio: default is 5558
- RTCP port for audio: default is 5559
- RTP port for video: default is 5556
- RTCP port for video: default is 5557

If you have changed the port numbers on the Network page, please open the ports accordingly on your router. For information on how to forward ports on the router, please refer to your router's user's manual.

3. Find out the public IP address of your router provided by your ISP (Internet Service Provider).

Use the public IP and the secondary HTTP port to access the Network Camera from the Internet. Please refer to Network Type on page 60 for details.

## Internet connection with static IP

Choose this connection type if you are required to use a static IP for the Network Camera. Please refer to LAN setting on page 60 for details.

## Internet connection via PPPoE (Point-to-Point over Ethernet)

Choose this connection type if you are connected to the Internet via a DSL Line. Please refer to PPPoE on page 61 for details.

## Software Installation

Installation Wizard 2 (IW2), a software included in the product CD, helps you set up your Network Camera on the LAN.

1. Install IW2 under the Software Utility directory from the software CD.  
Double-click the IW2 shortcut on your desktop to launch the program.



2. The program will conduct an analysis of your network environment.  
After your network environment is analyzed, please click **Next** to continue the program.



3. The program will search for all VIVOTEK network devices on the same LAN.
4. After a brief search, the installer window will prompt. Click on the MAC and model name that matches the one printed on the product label. You can then double-click on the address to open a management session with the Network Camera.



## Ready to Use

1. A browser session with the Network Camera should prompt as shown below.
2. You should be able to see live video from your camera. You may also install the 32-channel recording software from the software CD in a deployment consisting of multiple cameras. For its installation details, please refer to its related documents.

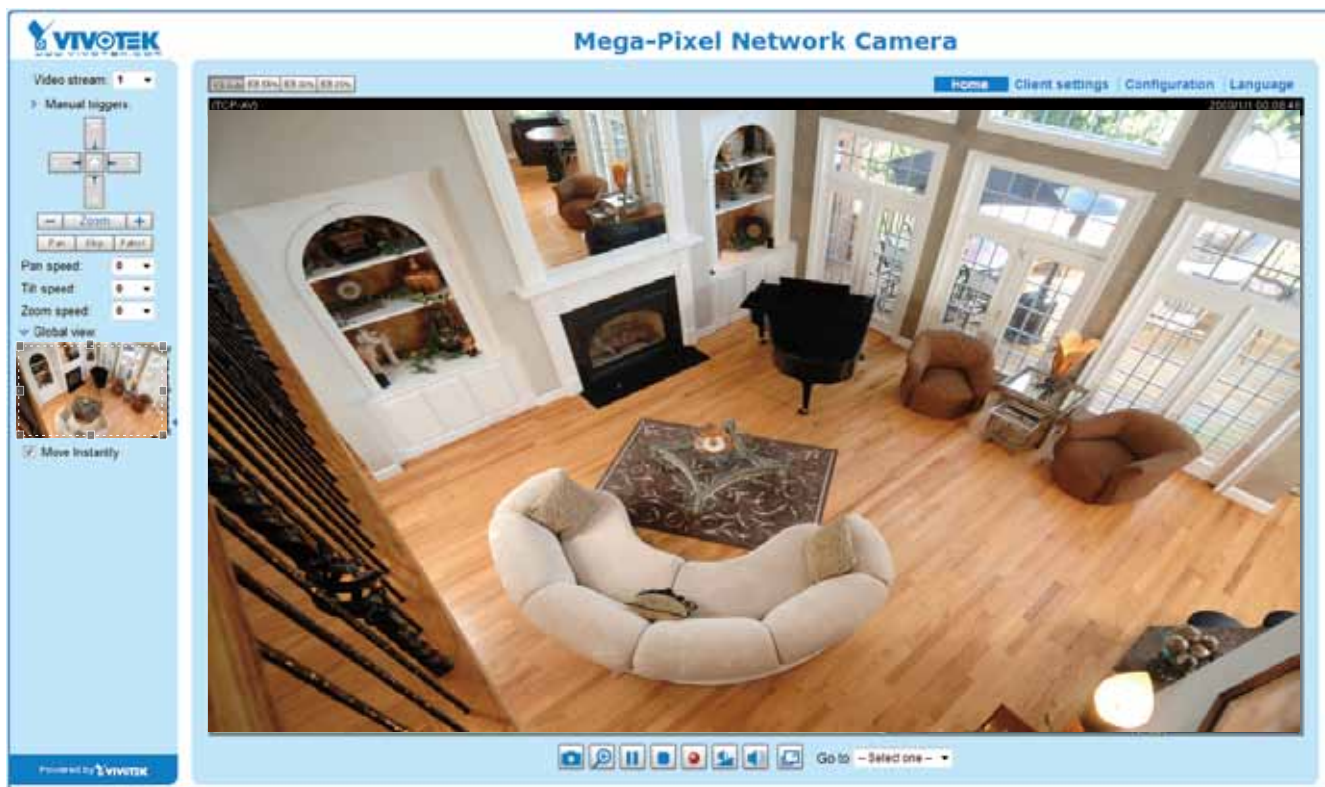

### **To adjust the viewing angle -- 3-axis mechanism design**

1. Loosen the tilt adjustment screws and then turn the lens module up or down, or swing left or right. Upon completion, tighten the screw.
2. Turn the lens to adjust the image orientation.

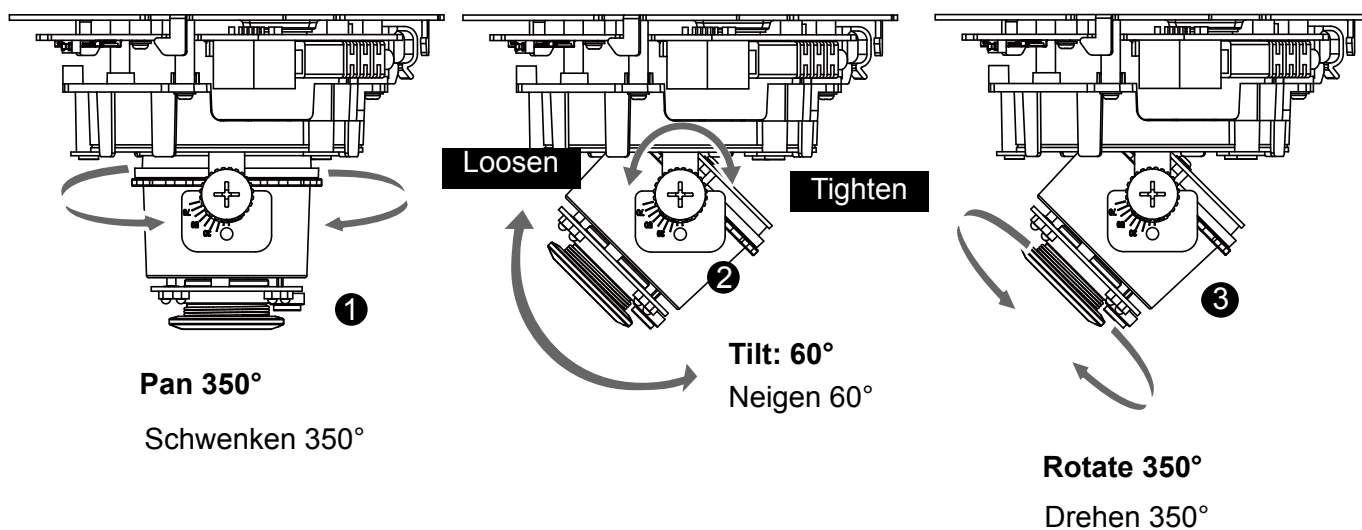

## Completion

1. Align the inner side of the black cover with the notches on both sides of the lens, fix the black cover.
2. If you choose to feed the cable through the ceiling/wall, arrange the cable neatly through the cable hole. If you choose to feed the cable from the side, remove the plastic side lid B.
3. Attach the dome cover to the camera as shown below. The dome cover cannot be attached if installed in the wrong orientation. Align the side lid (or side cutout) with where the cable comes out from the camera. Press the dome cover to join with the camera.
4. Finally, make sure all parts of the camera are securely installed.

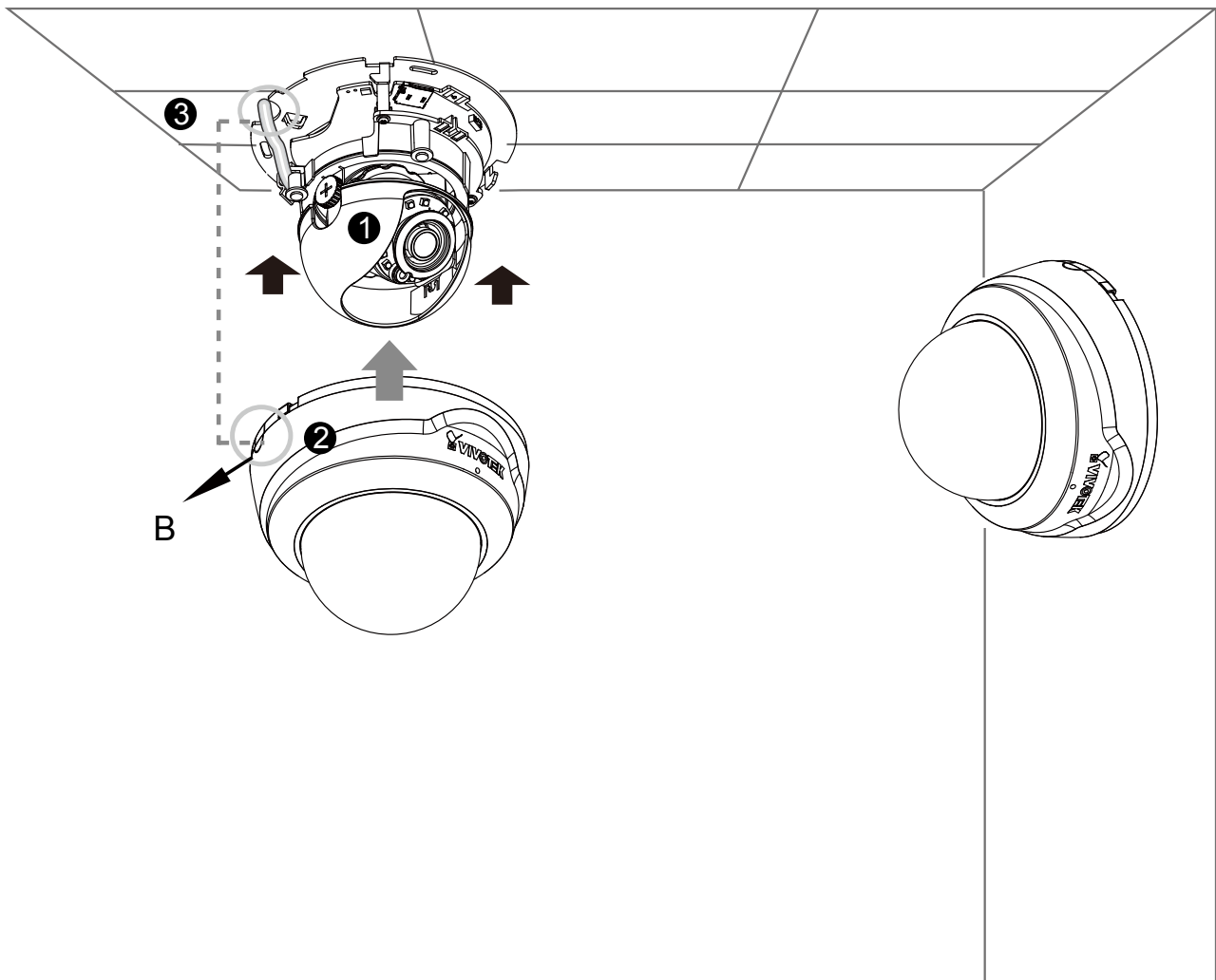



# Accessing the Network Camera

This chapter explains how to access the Network Camera through web browsers, RTSP players, 3GPP-compatible mobile devices, and VIVOTEK recording software.

## Using Web Browsers

Use Installation Wizard 2 (IW2) to access the Network Cameras on LAN.

If your network environment is not a LAN, follow these steps to access the Network Camera:

1. Launch your web browser (e.g., Microsoft® Internet Explorer or Mozilla Firefox).
2. Enter the IP address of the Network Camera in the address field. Press **Enter**.
3. Live video will be displayed in your web browser.
4. If it is the first time installing the VIVOTEK network camera, an information bar will prompt as shown below. Follow the instructions to install the required plug-in to your computer.

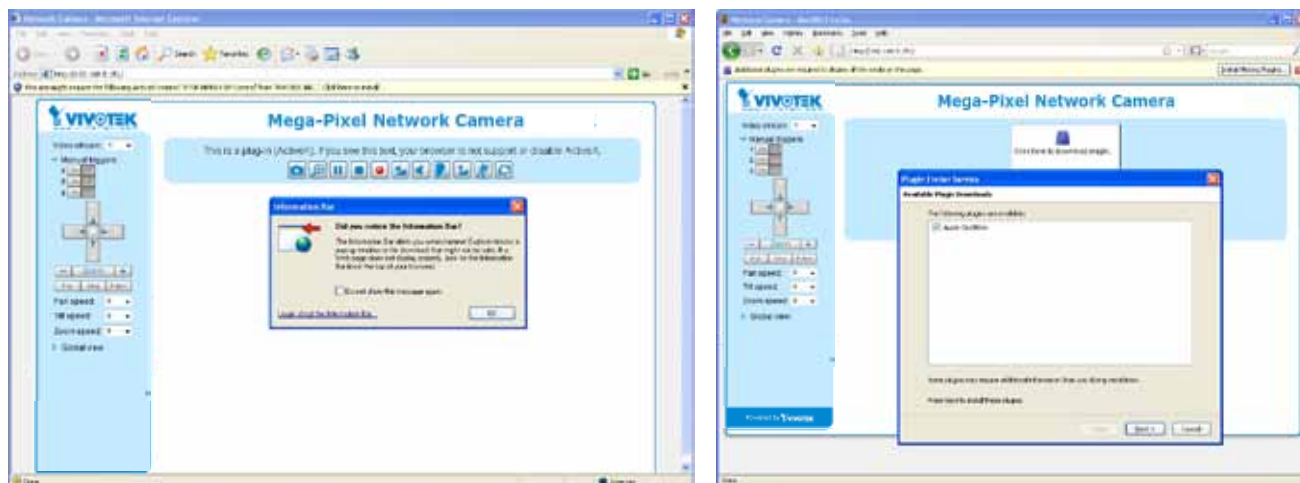

### NOTE:

- For Mozilla Firefox users, your browser will use Quick Time to stream the live video. If you don't have Quick Time on your computer, please download it first, then launch the web browser.

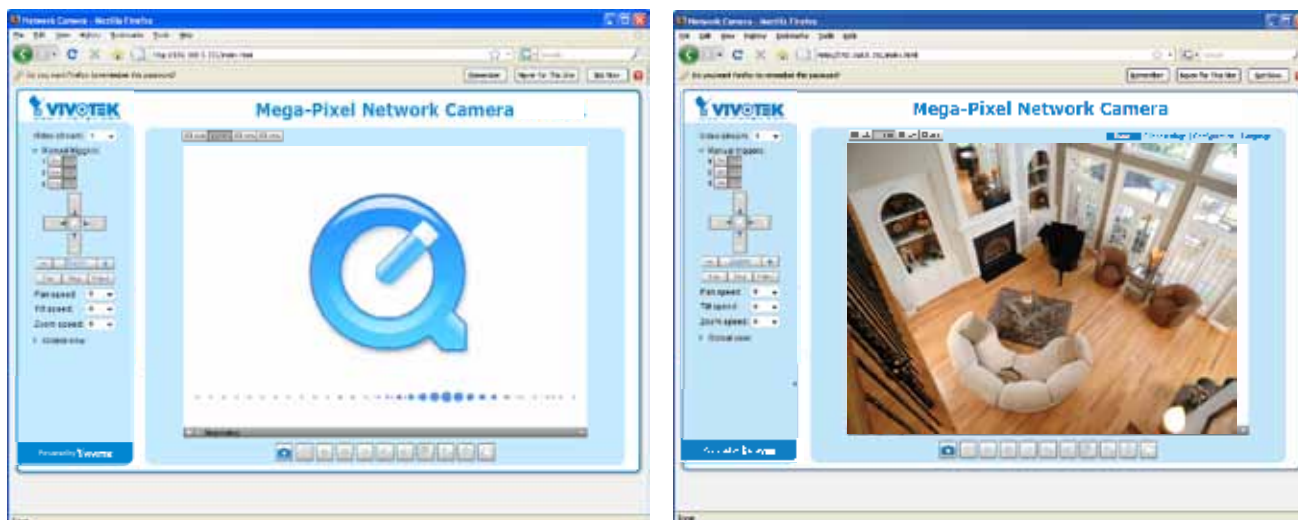

- ▶ *By default, the Network Camera is not password-protected. To prevent unauthorized access, it is highly recommended to set a password for the Network Camera. For more information about how to enable password protection, please refer to Security on page 77.*
- ▶ *If you see a dialog box indicating that your security settings prohibit running ActiveX® Controls, please enable the ActiveX® Controls for your browser.*

1. Choose **Tools > Internet Options > Security > Custom Level**.

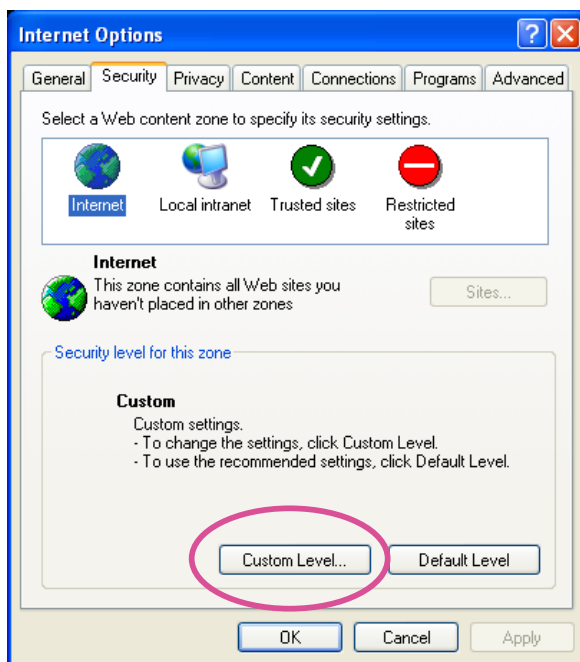

2. Look for **Download signed ActiveX® controls**; select **Enable or Prompt**. Click **OK**.

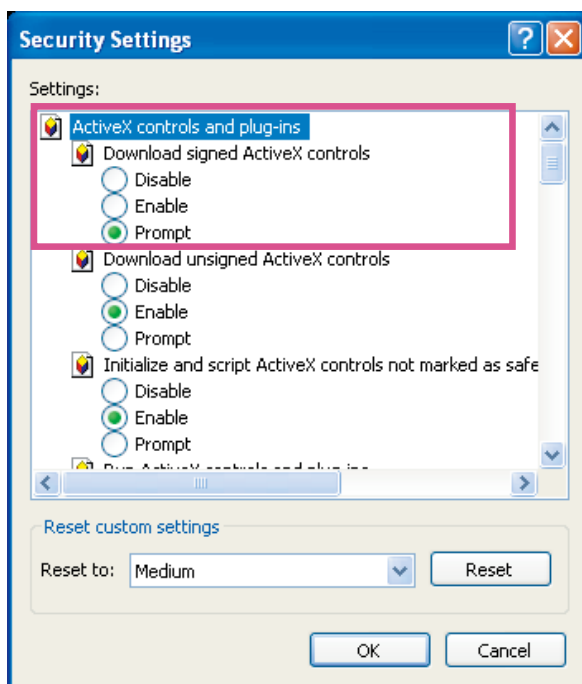

3. Refresh your web browser, then install the ActiveX® control. Follow the instructions to complete installation.



**IMPORTANT:**

- Currently the Network Camera utilizes 32-bit ActiveX plugin. You CAN NOT open a management/view session with the camera using a 64-bit IE browser.
- If you encounter this problem, try execute the Iexplore.exe program from C:\Windows\SysWOW64. A 32-bit version of IE browser will be installed.
- On Windows 7, the 32-bit explorer browser can be accessed from here:  
[C:\Program Files \(x86\)\Internet Explorer\Iexplore.exe](C:\Program Files (x86)\Internet Explorer\Iexplore.exe)
- If you open a web session from the IW2 utility, a 32-bit IE browser will be opened.

**Tips:**

- The onscreen Java control can malfunction under the following situations:  
A PC connects to different cameras that are using the same IP address (or the same camera running different firmware versions). Removing your browser cookies will solve this problem.
- In the event of plug-in compatibility issues, you may try to uninstall the plug-in that was previously installed.

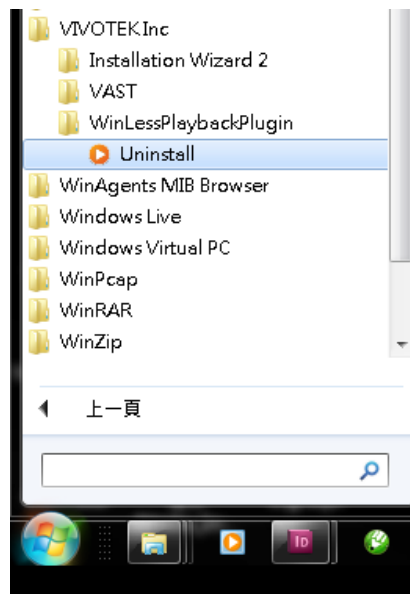

## Using RTSP Players

To view the streaming media using RTSP players, you can use one of the following players that support RTSP streaming.



Quick Time Player



VLC media player

1. Launch the RTSP player.
2. Choose File > Open URL. A URL dialog box will pop up.
3. The address format is `rtsp://<ip address>:<rtsp port>/<RTSP streaming access name for stream1 or stream2>`

As most ISPs and players only allow RTSP streaming through port number 554, please set the RTSP port to 554. For more information, please refer to RTSP Streaming on page 68.

For example:

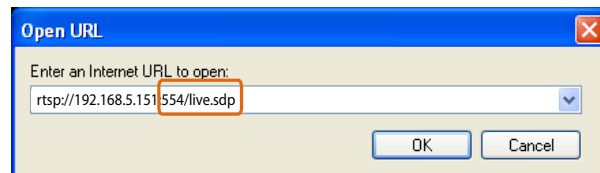

4. The live video will be displayed in your player.  
For more information on how to configure the RTSP access name, please refer to RTSP Streaming on page 68 for details.



## Using 3GPP-compatible Mobile Devices

To view the streaming media through 3GPP-compatible mobile devices, make sure the Network Camera can be accessed over the Internet. For more information on how to set up the Network Camera over the Internet, please refer to Setup the Network Camera over the Internet on page 15.

To utilize this feature, please check the following settings on your Network Camera:

1. Because most players on 3GPP mobile phones do not support RTSP authentication, make sure the authentication mode of RTSP streaming is set to disable.  
For more information, please refer to RTSP Streaming on page 68.
2. As the the bandwidth on 3G networks is limited, you will not be able to use a large video size. Please set the video and audio streaming parameters as listed below.  
For more information, please refer to Stream settings on page 54.

Video Mode	H.264
Frame size	176 x 144
Maximum frame rate	5 fps
Intra frame period	1S
Video quality (Constant bit rate)	40kbps

3. As most ISPs and players only allow RTSP streaming through port number 554, please set the RTSP port to 554. For more information, please refer to RTSP Streaming on page 68.
4. Launch the player on the 3GPP-compatible mobile devices (e.g., Quick Time).
5. Type the following URL commands into the player.  
The address format is `rtsp://<public ip address of your camera>:<rtsp port>/<RTSP streaming access name for stream # with small frame size and frame rate>`.  
For example:

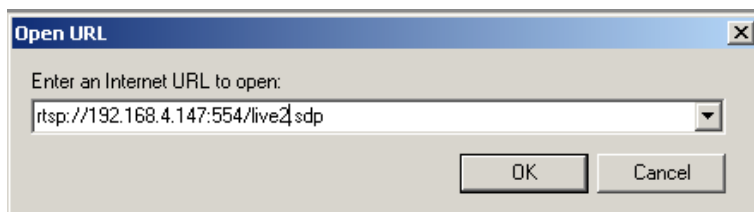

You can configure Stream #3 into the suggested stream settings as listed above for live viewing on a mobile device.

## Using VIVOTEK Recording Software

The product software CD also contains an ST7501 recording software, allowing simultaneous monitoring and video recording for multiple Network Cameras. Please install the recording software; then launch the program to add the Network Camera to the Channel list. For detailed information about how to use the recording software, please refer to the user's manual of the software or download it from <http://www.vivotek.com>.



# Main Page

This chapter explains the layout of the main page. It is composed of the following sections: VIVOTEK INC. Logo, Host Name, Camera Control Area, Configuration Area, Menu, and Live Video Window.

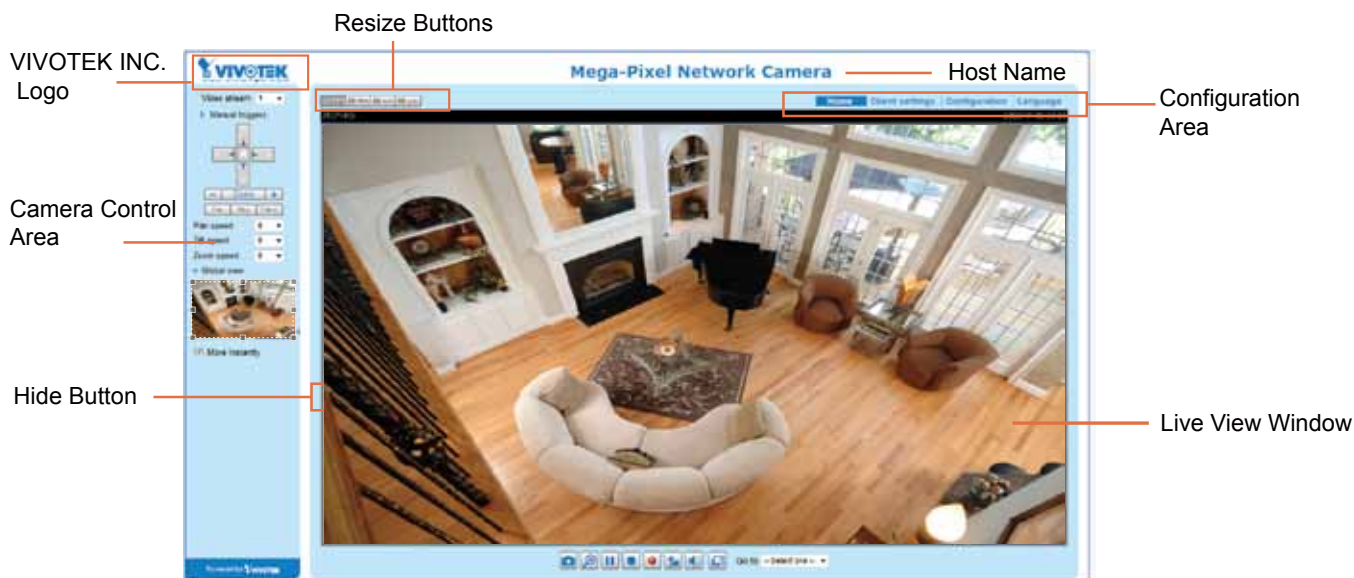

## VIVOTEK INC. Logo

Click this logo to visit the VIVOTEK website.

## Host Name

The host name can be customized to fit your needs. The name can be changed especially there are many cameras in your surveillance deployment. For more information, please refer to System on page 35.

## Camera Control Area

**Video Stream:** This Network Camera supports multiple streams (streams 1 ~ 2) simultaneously. You can select any of them for live viewing. For more information about multiple streams, please refer to page 54 for detailed information.

**Manual Trigger:** Click to enable/disable an event trigger manually. Please configure an event setting on the Application page before you enable this function. A total of 3 event configuration can be configured. For more information about event setting, please refer to page 93. If you want to hide this item on the homepage, please go to **Configuration > System > Homepage Layout > General settings > Customized button** to deselect the "show manual trigger button" checkbox.



## Configuration Area

**Client Settings:** Click this button to access the client setting page. For more information, please refer to Client Settings on page 30.

**Configuration:** Click this button to access the configuration page of the Network Camera. It is suggested that a password be applied to the Network Camera so that only the administrator can configure the Network Camera. For more information, please refer to Configuration on page 34.

**Language:** Click this button to choose a language for the user interface. Language options are available in: English, Deutsch, Español, Français, Italiano, 日本語, Português, 簡體中文, and 繁體中文. Please note that you can also change a language on the Configuration page; please refer to page 34.

## Hide Button

You can click the hide button to hide or display the control panel.

## Resize Buttons



Click the Auto button, the video cell will resize automatically to fit the monitor.

Click 100% is to display the original homepage size.

Click 50% is to resize the homepage to 50% of its original size.

Click 25% is to resize the homepage to 25% of its original size.

## Live Video Window

- The following window is displayed when the video mode is set to H.264:

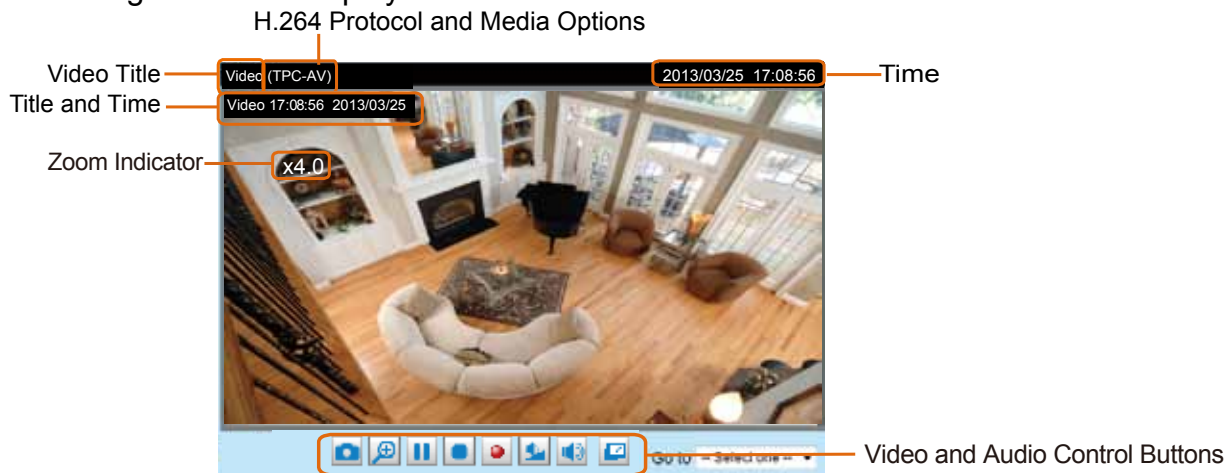

**Video Title:** The video title can be configured. For more information, please refer to Video Settings on page 47.

**H.264 Protocol and Media Options:** The transmission protocol and media options for H.264 video streaming. For further configuration, please refer to Client Settings on page 30.

**Time:** Display the current time. For further configuration, please refer to Media > Image > Genral settings on page 47.

**Title and Time:** The video title and time can be stamped on the streaming video. For further configuration, please refer to Media > Image > General settings on page 49.

**PTZ Panel:** This Network Camera supports “digital” (e-PTZ) pan/tilt/zoom control, which allows roaming a smaller view frame within a large view frame. Please refer to PTZ settings on page 90 for detailed information.

**Global View:** Click on this item to display the Global View window. The Global View window contains a full view image (the largest frame size of the captured video) and a floating frame (the viewing region of the current video stream). The floating frame allows users to control the e-PTZ function (Electronic Pan/Tilt/Zoom). For more information about e-PTZ operation, please refer to e-PTZ Operation on page 90. For more information about how to set up the viewing region of the current video stream, please refer to page 90.

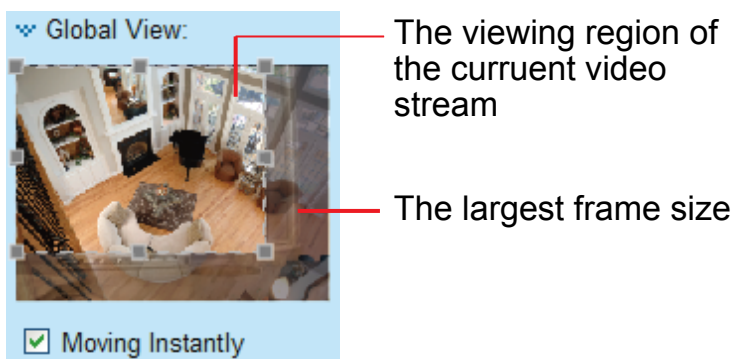



Note that the PTZ buttons on the panel are not operational unless you are showing only a portion of the full image. If the live view window is displaying the full view, the PTZ buttons are not functional.



**Video and Audio Control Buttons:** Depending on the Network Camera model and Network Camera configuration, some buttons may not be available.

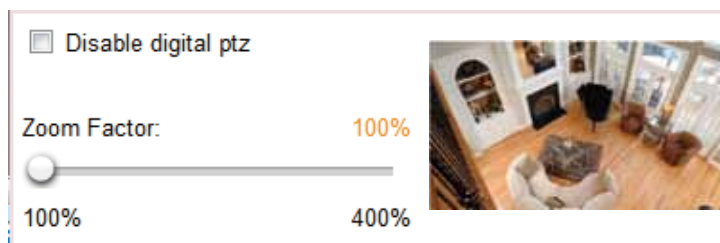

 **Snapshot:** Click this button to capture and save still images. The captured images will be displayed in a pop-up window. Right-click the image and choose **Save Picture As** to save it in JPEG (\*.jpg) or BMP (\*.bmp) format.



 **Digital Zoom:** Click and uncheck “Disable digital zoom” to enable the zoom operation. The navigation screen indicates the part of the image being magnified. To control the zoom level, drag the slider bar. To move to a different area you want to magnify, drag the navigation screen.





 **Volume:** When the  Mute function is not activated, move the slider bar to adjust the volume on the local computer.

 **Mute:** Turn off the volume on the local computer. The button becomes the  Audio On button after clicking the Mute button.

 **Pause:** Pause the transmission of the streaming media. The button becomes the  **Resume** button after clicking the Pause button.

 **Stop:** Stop the transmission of the streaming media. Click the  **Resume** button to continue transmission.

 **Start MP4 Recording:** Click this button to record video clips in MP4 file format to your computer. Press the  **Stop MP4 Recording** button to end recording. When you exit the web browser, video recording stops accordingly. To specify the storage destination and file name, please refer to MP4 Saving Options on page 31 for details.

 **Full Screen:** Click this button to switch to full screen mode. Press the “Esc” key to switch back to normal mode.

**Go to**

If you configured and chose to display a smaller region of interest from out of a maximum image frame, you can configure different areas within the frame as preset points, and use this menu to move to a location.

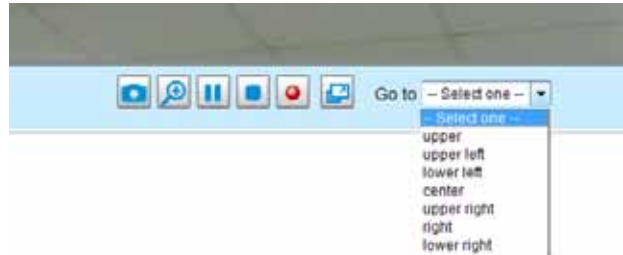

A zoom indicator will be displayed on the Home page when you zoom in/out on the live viewing window as shown below. You may zoom in/out on the image by scrolling the mouse wheel inside the live viewing window, and the maximum zoom in will be up to 4 times.

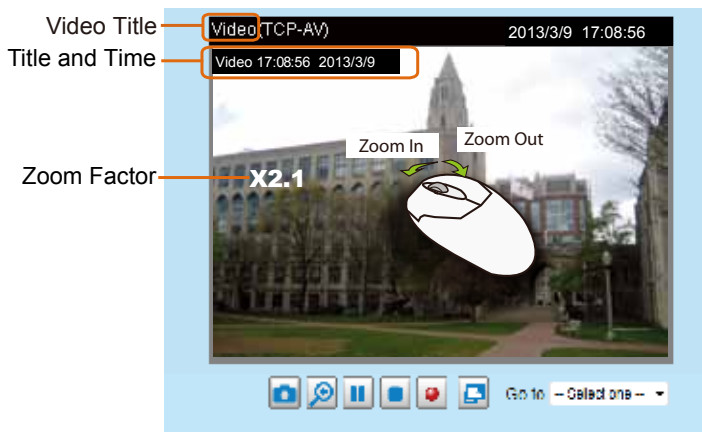



- The following window is displayed when the video mode is set to MJPEG:

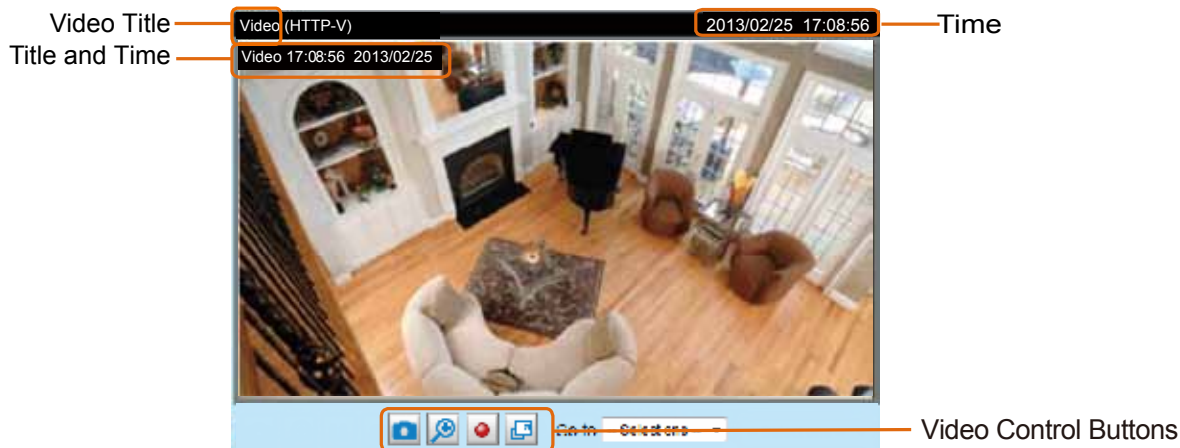



**Video Title:** The video title can be configured. For more information, please refer to Media > Image on page 49.

**Time:** Display the current time. For more information, please refer to Media > Image on page 49.



**Title and Time:** Video title and time can be stamped on the streaming video. For more information, please refer to Media > Image on page 49.

**Video and Audio Control Buttons:** Depending on the Network Camera model and Network Camera configuration, some buttons may not be available.

 **Snapshot:** Click this button to capture and save still images. The captured images will be displayed in a pop-up window. Right-click the image and choose **Save Picture As** to save it in JPEG (\*.jpg) or BMP (\*.bmp) format.

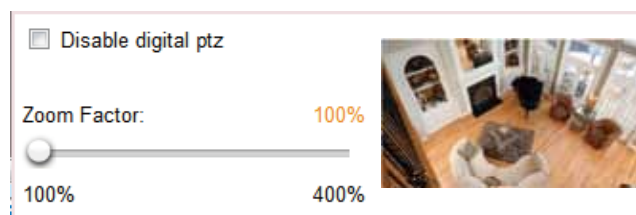
 **Digital Zoom:** Click and uncheck “Disable digital zoom” to enable the zoom operation. The navigation screen indicates the part of the image being magnified. To control the zoom level, drag the slider bar. To move to a different area you want to magnify, drag the navigation screen.



 **Start MP4 Recording:** Click this button to record video clips in MP4 file format to your computer. Press the  **Stop MP4 Recording** button to end recording. When you exit the web browser, video recording stops accordingly. To specify the storage destination and file name, please refer to MP4 Saving Options on page 31 for details.

 **Full Screen:** Click this button to switch to full screen mode. Press the “Esc” key to switch back to normal mode.

# Client Settings

This chapter explains how to select the stream transmission mode and saving options on the local computer. When completed with the settings on this page, click **Save** on the page bottom to enable the settings.

## H.264 Protocol Options

**H.264 protocol options**

UDP Unicast

UDP Multicast

TCP

HTTP

Depending on your network environment, there are four transmission modes of H.264 streaming:

**UDP unicast:** This protocol allows for more real-time audio and video streams. However, network packets may be lost due to network burst traffic and images may be broken. Activate UDP connection when occasions require time-sensitive responses and the video quality is less important. Note that each unicast client connecting to the server takes up additional bandwidth and the Network Camera allows up to ten simultaneous accesses.

**UDP multicast:** This protocol allows multicast-enabled routers to forward network packets to all clients requesting streaming media. This helps to reduce the network transmission load of the Network Camera while serving multiple clients at the same time. Note that to utilize this feature, the Network Camera must be configured to enable multicast streaming at the same time. For more information, please refer to RTSP Streaming on page 68.

**TCP:** This protocol guarantees the complete delivery of streaming data and thus provides better video quality. The downside of this protocol is that its real-time effect is not as good as that of the UDP protocol.

**HTTP:** This protocol allows the same quality as TCP protocol without needing to open specific ports for streaming under some network environments. Users inside a firewall can utilize this protocol to allow streaming data through.

## MP4 Saving Options

**MP4 Saving Options**

Folder:

File name prefix:

Add date and time suffix to file name

Users can record live video as they are watching it by clicking  Start MP4 Recording on the main page. Here, you can specify the storage destination and file name.

**Folder:** Specify a storage destination on your PC for the recorded video files. The location can be changed.

**File name prefix:** Enter the text that will be appended to the front of the video file name. A specified folder will be automatically created on your local hard disk.

**Add date and time suffix to the file name:** Select this option to append the date and time to the end of the file name.

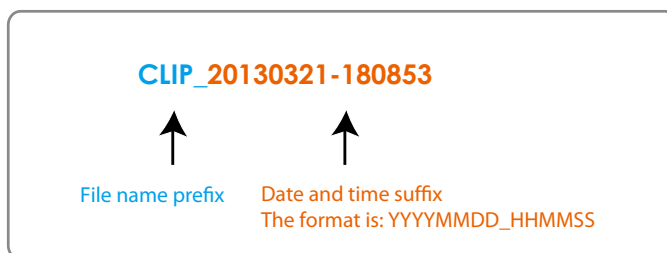

## Local Streaming Buffer Time

**Local streaming buffer time**

Millisecond

In a network environment with unsteady bandwidth allocated, the live streaming may lag and not be very smoothly. If you enable this option, the live streaming will be stored temporarily on your PC's cache memory for a few seconds before being played on the live viewing window. This will help you see the streaming more smoothly. For example, If you enter 3,000 Millisecond, the streaming will delay for 3 seconds.

## Joystick Settings

**Joystick settings**

Selected joystick: CH PRODUCTS IP DESKTOP CONTROLLER ▾

Calibrate      Configure buttons

Save

### Enable Joystick

Connect to the USB plug of the joystick to a USB port on your management computer. Supported by the plug-in in the main page (Microsoft's DirectX), once the plug-in in the main page is loaded, it will automatically detect if there is any joystick on the computer. The joystick should work properly without installing any other driver or software.

Then you can begin to configure the joystick settings of connected devices. Please follow the instructions below to enable joystick settings.

1. Right-click on a live view window. Select Joystick Settings. If your joystick is working properly, it will be displayed on the drop-down list.
2. Select the joystick you want to configure. Check **Enable Joystick**, then click **Configure Buttons** to open Buttons configuration window.



### NOTE:

- If you want to assign Preset actions to your joystick, the preset locations should be configured in advance in the Configuration > PTZ page.
- If your joystick is not working properly, it may need to be calibrated. Click the **Calibrate** button to open the Game Controllers window located in Microsoft Windows control panel and follow the instructions for trouble shooting.
- The joystick will appear in the **Game Controllers** list in the Windows Control panel. If you want to check out for your devices, go to the following page: Start -> Control Panel -> Game Controllers.



## Buttons Configuration

Click the **Configure Buttons** button, a window will prompt as shown below. Please follow the steps below to configure your joystick buttons:

1. Select a button number from the Button # pull-down menu.

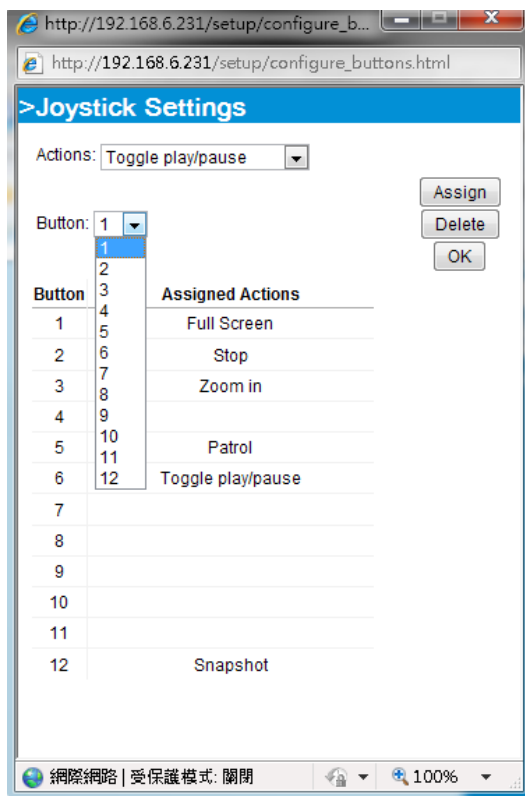

### Tips

If you are not sure of the locations of each button, use the **Properties** window in the **Game Controllers** utility.

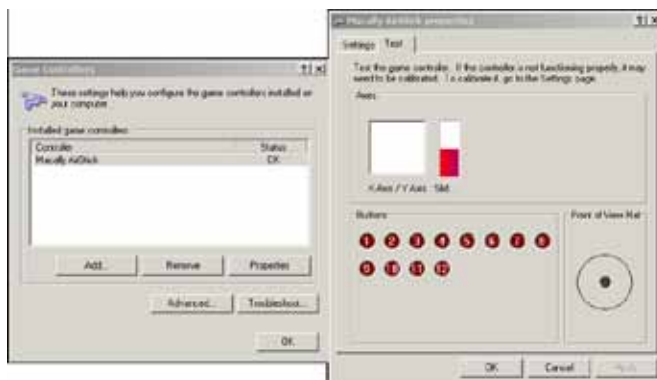

2. Select a corresponding action, such as Patrol or Preset#.

3. Click the **Assign** button to assign an action to the button. You can delete an association by selecting a button number, and then click the **Delete** button.

Repeat the process until you are done with the configuration of all preferred actions.

The buttons you define should appear on the button list accordingly.

4. Please remember to click the **Save** button on the Client settings page to preserve your settings.

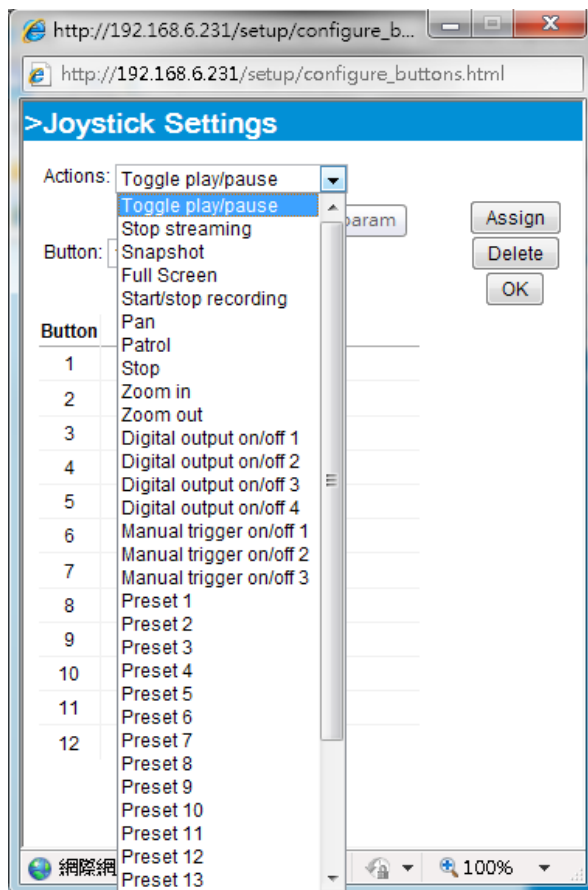

# Configuration

Click **Configuration** on the main page to enter the camera setting pages. Note that only Administrators can access the configuration page.

VIVOTEK offers an easy-to-use user interface that helps you set up your network camera with minimal effort. To simplify the setting procedure, two types of user interfaces are available: Advanced Mode for professional users and Basic Mode for entry-level users. Some advanced functions (PTZ/ Event/ Recording/ Local storage) are not displayed in the Basic Mode.

If you want to set up advanced functions, please click **[Advanced Mode]** on the bottom of the configuration list to quickly switch to Advanced Mode.

In order to simplify the user interface, the detailed information will be hidden unless you click on the function item. When you click on the first sub-item, the detailed information for the first sub-item will be displayed; when you click on the second sub-item, the detailed information for the second sub-item will be displayed and that of the first sub-item will be hidden.

The following is the interface of the Basic Mode and the Advanced Mode:

## Basic Mode

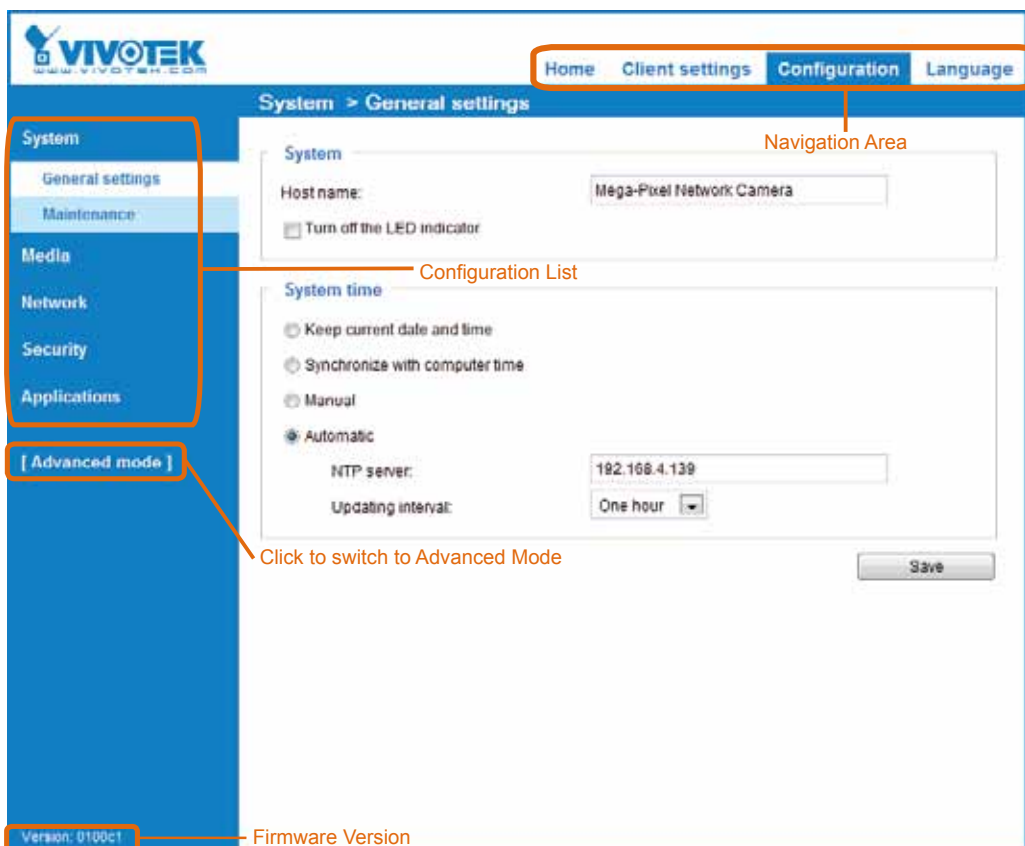

## Advanced Mode

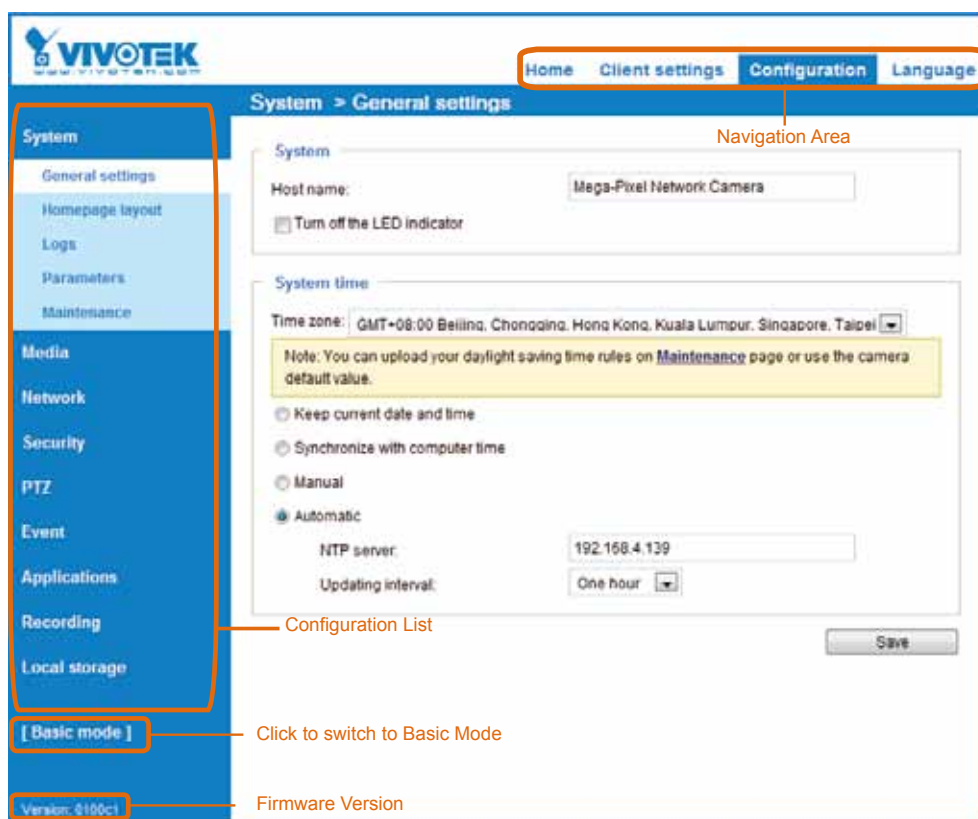

Each function on the configuration list will be explained in the following sections. Those functions that are displayed only in Advanced Mode are marked with **Advanced Mode**. If you want to set up advanced functions, please click **[Advanced Mode]** on the bottom of the configuration list to quickly switch over.

Navigation Area provides an instant switch among **Home** page (the monitoring page for live viewing), **Client settings**, **Configuration** page, and multi-language selection.

## System > General settings

This section explains how to configure the basic settings for the Network Camera, such as the host name and system time. It is composed of the following two columns: System, and System Time. When finished with the settings on this page, click **Save** at the bottom of the page to enable the settings.

### System

**System**

Host name:

Turn off the LED indicator

**Host name:** Enter a desired name for the Network Camera. The text will be displayed at the top of the main page, and also on the view cells of the ST7501 and VAST management software.

**Turn off the LED indicators:** If you do not want others to notice the network camera is in operation, you can select this option to turn off the LED indicators.

## System time

**System time**

Time zone: GMT+08:00 Beijing, Chongqing, Hong Kong, Kuala Lumpur, Singapore, Taipei ▾

Note: You can upload your daylight saving time rules on [Maintenance](#) page or use the camera default value.

Keep current date and time

Synchronize with computer time

Manual

Automatic

**Keep current date and time:** Select this option to preserve the current date and time of the Network Camera. The Network Camera's internal real-time clock maintains the date and time even when the power of the system is turned off.

**Synchronize with computer time:** Select this option to synchronize the date and time of the Network Camera with the local computer. The read-only date and time of the PC is displayed as updated.

**Manual:** The administrator can enter the date and time manually. Note that the date and time format are [yyyy/mm/dd] and [hh:mm:ss].

**Automatic:** The Network Time Protocol is a protocol which synchronizes computer clocks by periodically querying an NTP Server.

**NTP server:** Assign the IP address or domain name of the time-server. Leaving the text box blank connects the Network Camera to the default time servers. The precondition is that the camera must have the access to the Internet.

**Update interval:** Select to update the time using the NTP server on an hourly, daily, weekly, or monthly basis.

**Time zone Advanced Mode:** Select the appropriate time zone from the list. If you want to upload Daylight Savings Time rules, please refer to **System > Maintenance > Import/ Export files** on page 44 for details.



## System > Homepage layout Advanced Mode

This section explains how to set up your own customized homepage layout.

### General settings

This column shows the settings of your homepage layout. You can manually select the background and font colors in Theme Options (the second tab on this page). The settings will be displayed automatically in this Preview field. The following shows the homepage using the default settings:



- **Hide Powered by VIVOTEK:** If you check this item, it will be removed from the homepage.

### Logo graph

Here you can change the logo that is placed at the top of your homepage.

**Logo graph**

A customized logo (Gif, JPG or PNG) can be uploaded for main page. It will be resized to 160x50 pixels to replace the previous logo.

Default
  Custom



Logo link:

Follow the steps below to upload a new logo:

1. Click **Custom** and the Browse field will appear.
2. Select a logo from your files.
3. Click **Upload** to replace the existing logo with a new one.
4. Enter a website link if necessary.
5. Click **Save** to enable the settings.

### Customized button

If you want to hide manual trigger buttons on the homepage, please uncheck this item. This item is checked by default.

**Customized button**

Show manual trigger button

## Theme Options

Here you can change the color of your homepage layout. There are three types of preset patterns for you to choose from. The new layout will simultaneously appear in the **Preview** filed. Click **Save** to enable the settings.

General settings | Theme options

Font Color of the Video Title

Font Color

Background Color of the Control Area

Font Color of the Configuration Area

Background Color of the Configuration Area

Background Color of the Video Area

Frame Color

Video stream 1

Manual triggers:

Powered by VIVOTEK

Themes

Preset patterns

Color

Font color:	#000000
Font color of configuration area:	#FFFFFF
Font color of video title:	#098BD6
Bk color of control area:	#C4EAFF
Bk color of configuration area:	#0186D1
Bk color of video area:	#C4EAFF
Frame color:	#0186D1

Save

General settings | Theme options

VIVOTEK  
www.vivotek.com

Mega-Pixel Network

Video stream 1

Manual triggers:

Powered by VIVOTEK

General settings | Theme options

VIVOTEK  
www.vivotek.com

Mega-Pixel Network

Video stream 1

Manual triggers:

Powered by VIVOTEK

■ Follow the steps below to customize your homepage:

1. Click **Custom** on the left column.
2. Click the field where you want to change the color on the right column.

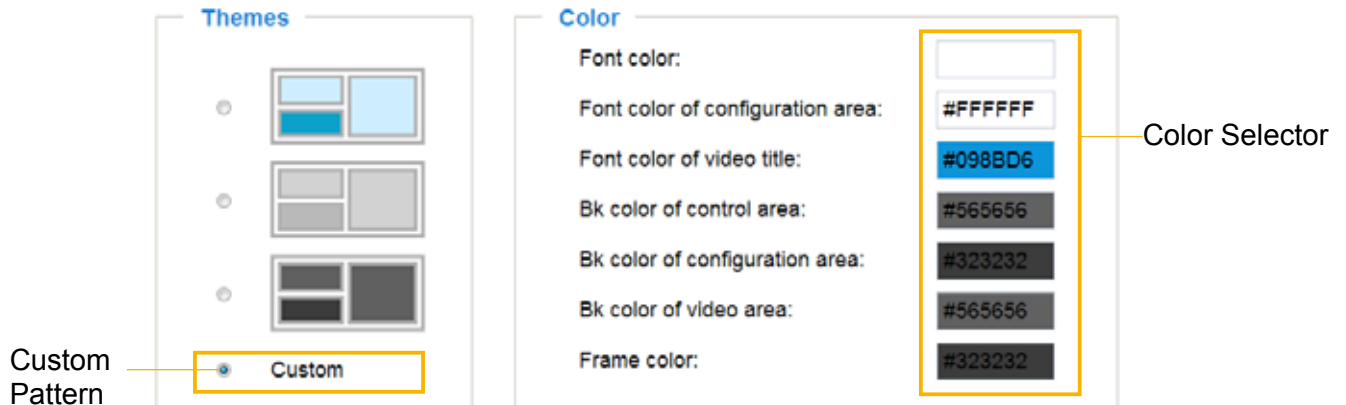

3. The palette window will pop up as shown below.

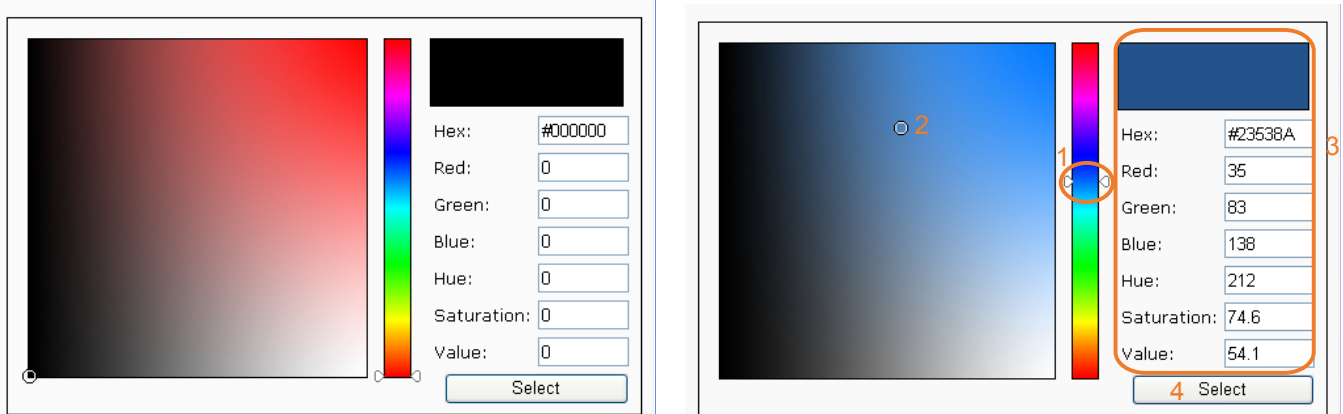

4. Drag the slider bar and click on the left square to select a desired color.
5. The selected color will be displayed in the corresponding fields and in the **Preview** column.
6. Click **Save** to enable the settings.

## System > Logs Advanced Mode

This section explains how to configure the Network Camera to send the system log to a remote server as backup.

### Log server settings

Follow the steps below to set up the remote log:

1. Select **Enable remote log**.
2. In the IP address text box, enter the IP address of the remote server.
2. In the port text box, enter the port number of the remote server.
3. When completed, click **Save** to enable the setting.

You can configure the Network Camera to send the system log file to a remote server as a log backup. Before utilizing this feature, it is suggested that the user install a log-recording tool to receive system log messages from the Network Camera. An example is Kiwi Syslog Daemon. Visit <http://www.kiwisyslog.com/kiwi-syslog-daemon-overview/>.

Date	Time	Priority	Hostname	Message
01-12-2008	15:21:32	User.Info	192.168.5.121	[RTSP SERVER] Stop one session, IP=192.168.5.122
01-12-2008	15:21:31	User.Info	192.168.5.121	[RTSP SERVER] Start one session, IP=192.168.5.122
01-12-2008	15:20:47	Syslog.Info	192.168.5.121	syslogd 1.4.1: restart.

### System log

```

Jan 5 11:36:07 syslogd 1.5.0: restart.
Jan 5 11:36:08 [swatchdog]: Ready to watch httpd.
Jan 5 11:36:09 [EVENT MGR]: Starting eventmgr with support for EcTun
Jan 5 11:36:11 [DRM Service]: Starting DRM service.
Jan 5 11:36:20 [UPnPIGDCP]: Search IGD failed
Jan 5 11:36:23 automount[718]: >> mount: mounting /dev/mmcbk0p1 on /mnt/auto/CF failed: No such device or address
Jan 5 11:36:23 automount[718]: mount(generic): failed to mount /dev/mmcbk0p1 (type vfat) on /mnt/auto/CF
Jan 5 11:36:23 [IR Cut Control]: Day mode
Jan 5 11:36:23 automount[728]: >> mount: mounting /dev/mmcbk0p1 on /mnt/auto/CF failed: No such device or address
Jan 5 11:36:23 automount[728]: mount(generic): failed to mount /dev/mmcbk0p1 (type vfat) on /mnt/auto/CF
Jan 5 11:36:23 [IR Cut Control]: Day mode
Jan 5 11:36:23 [SYS]: Serial number = 0002D10ED4C9
Jan 5 11:36:23 [SYS]: System starts at Wed Jan 5 11:36:23 UTC 2011

```

This column displays the system log in a chronological order. The system log is stored in the Network Camera's buffer area and will be overwritten when reaching a certain limit.

You can install the included ST7501 recording software, which provides an Event Management function group for delivering event messages via emails, GSM short messages, onscreen event panel, or to trigger an alarm, etc. For more information, refer to the ST7501 User Manual.

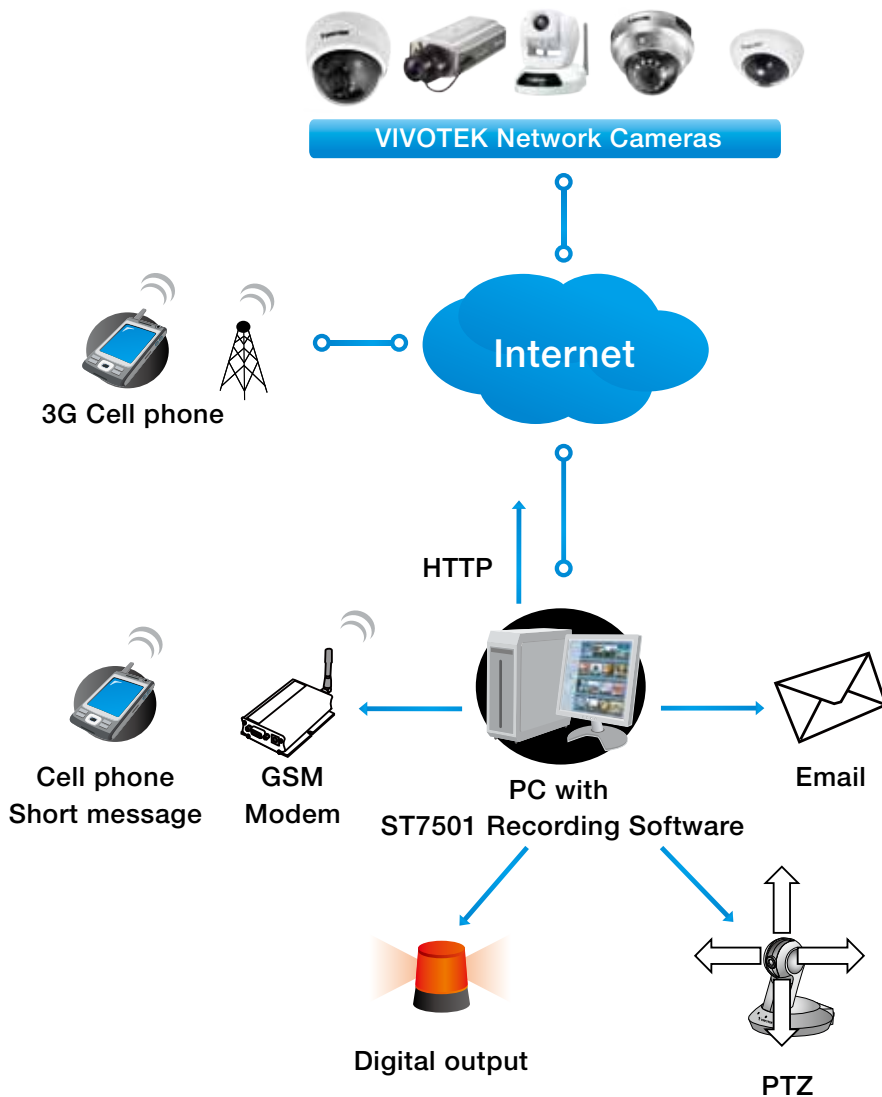

## Access log

System log

Access log

```
Jan 5 11:36:28 [RTSP SERVER]: Start one session, IP=172.16.2.52
Jan 5 11:49:15 [RTSP SERVER]: Start one session, IP=192.168.4.105
Jan 5 13:11:20 [RTSP SERVER]: Start one session, IP=192.168.4.105
```

Access log displays the access time and IP address of all viewers (including operators and administrators) in a chronological order. The access log is stored in the Network Camera's buffer area and will be overwritten when reaching a certain limit.

## System > Parameters Advanced Mode

The View Parameters page lists the entire system's parameters. If you need technical assistance, please provide the information listed on this page.

### Parameters

```
system_hostname='Mega-Pixel Network Camera'
system_ledoff='0'
system_lowlight='1'
system_date='2000/01/02'
system_time='17:06:34'
system_datetime=''
system_ntp=''
system_timezoneindex='320'
system_daylight_enable='0'
system_daylight_dstactualmode='1'
system_daylight_auto_begintime='NONE'
system_daylight_auto_endtime='NONE'
system_daylight_timezones=',-360,-320,-280,-240,-241,-200,-201,-160'
system_updateinterval='0'
system_info_modelname='FD8137H'
system_info_extendedmodelname='FD8137H'
system_info_serialnumber='0002D124C50E'
system_info_firmwareversion='FD8137-VVTK-0100b'
system_info_language_count='9'
system_info_language_i0='English'
system_info_language_i1='Deutsch'
system_info_language_i2='Español'
system_info_language_i3='Français'
```

## System > Maintenance

This chapter explains how to restore the Network Camera to factory default, upgrade firmware version, etc.

### General settings > Upgrade firmware

#### — Upgrade firmware

Firmware file:  No file selected.

This feature allows you to upgrade the firmware of your Network Camera. It takes a few minutes to complete the process.

**Note: Do not power off the Network Camera during the upgrade!**

Follow the steps below to upgrade the firmware:

1. Download the latest firmware file from the VIVOTEK website. The file is in .pkg file format.
2. Click **Browse...** and locate the firmware file.
3. Click **Upgrade**. The Network Camera starts to upgrade and will reboot automatically when the upgrade completes.

If the upgrade is successful, you will see “Reboot system now!! This connection will close”. After that, re-access the Network Camera.

The following message is displayed when the upgrade has succeeded.

Reboot system now!!  
This connection will close.

The following message is displayed when you have selected an incorrect firmware file.

Starting firmware upgrade...  
Do not power down the server during the upgrade.  
The server will restart automatically after the upgrade is completed.  
This will take about 1 - 5 minutes.  
Wrong PKG file format  
Unpack fail

### General settings > Reboot

Reboot

This feature allows you to reboot the Network Camera, which takes about one minute to complete. When completed, the live video page will be displayed in your browser. The following message will be displayed during the reboot process.

The device is rebooting now. Your browser will reconnect to <http://192.168.5.151:80/>  
If the connection fails, please manually enter the above IP address in your browser.



If the connection fails after rebooting, manually enter the IP address of the Network Camera in the address field to resume the connection.

## General settings > Restore

— **Restore** —

Restore all settings to factory default except settings in

Network
  Daylight saving time
  Custom language
  Vadv

This feature allows you to restore the Network Camera to factory default settings.

**Network:** Select this option to retain the Network Type settings (please refer to Network Type on page 61).

**Daylight Saving Time:** Select this option to retain the Daylight Saving Time settings (please refer to Import/Export files below on this page).

**Custom Language:** Select this option to retain the Custom Language settings.

**VADP:** Retain the VADP modules (3rd-party software stored on the SD card) and related settings.

If none of the options is selected, all settings will be restored to factory default. The following message is displayed during the restoring process.

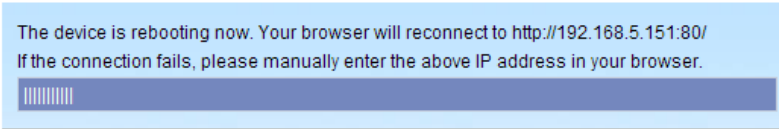

## Import/Export files **Advanced Mode**

This feature allows you to Export / Update daylight saving time rules, custom language file, configuration file, and server status report.

General settings | **Import/Export files**

**Export files**

Export daylight saving time configuration file

Export language file

Export configuration file

Export server status report

**Upload files**

Update daylight saving time rules:

Update custom language file:

Upload configuration file:

**Export daylight saving time configuration file:** Click to set the start and end time of DST (Daylight Saving).

Follow the steps below to export:

1. In the Export files column, click **Export** to export the daylight saving time configuration file from the Network Camera.
2. A file download dialog will pop up as shown below. Click **Open** to review the XML file or click **Save** to store the file for editing.



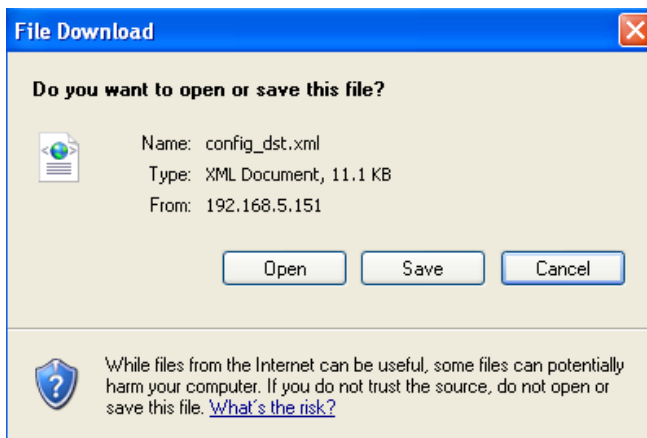

- Open the file with Microsoft® Notepad and locate your time zone; set the start and end time of DST. When completed, save the file.

In the example below, DST begins each year at 2:00 a.m. on the second Sunday in March and ends at 2:00 a.m. on the first Sunday in November.

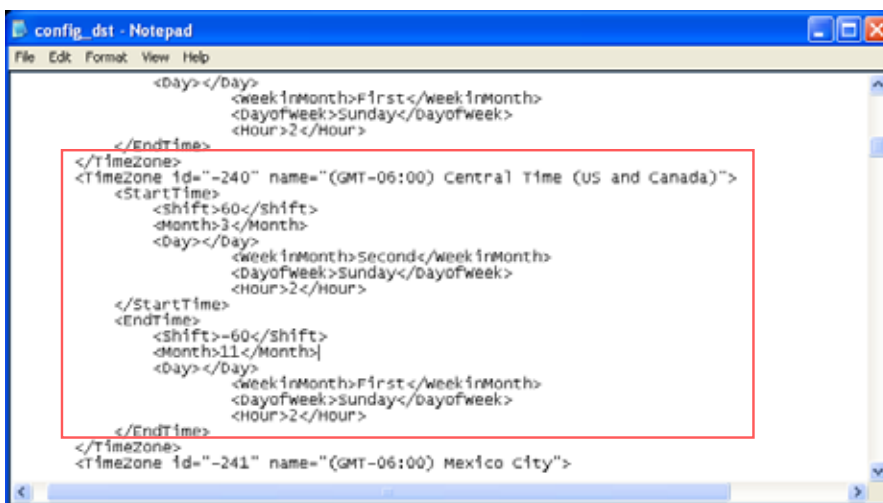

Update daylight saving time rules: Click **Browse...** and specify the XML file to update.

If the incorrect date and time are assigned, you will see the following warning message when uploading the file to the Network Camera.

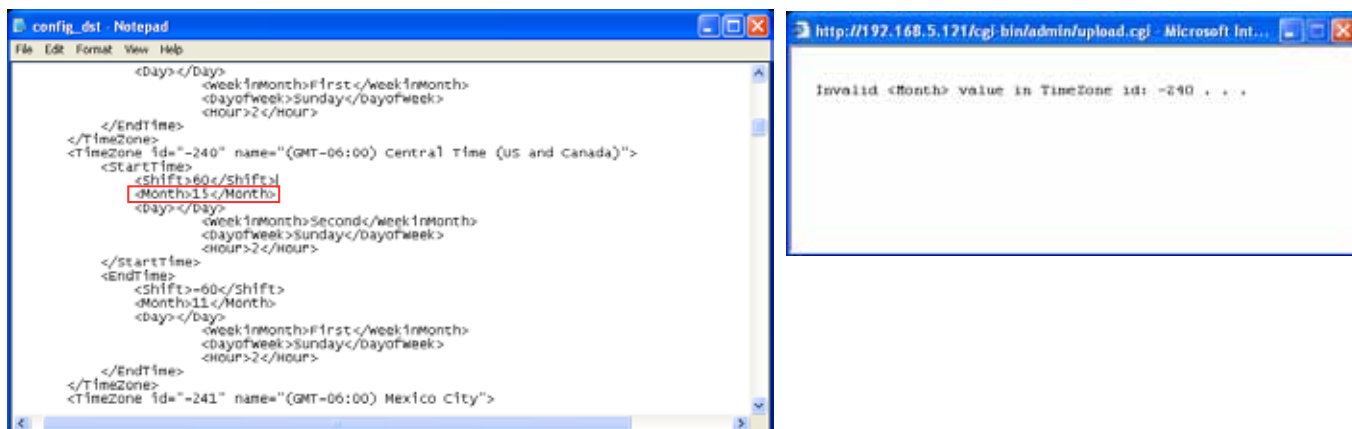

The following message is displayed when attempting to upload an incorrect file format.

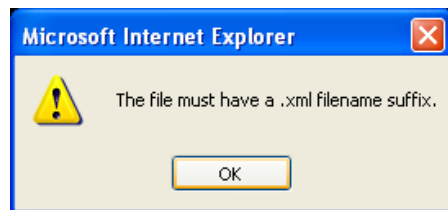

Export language file: Click to export language strings. VIVOTEK provides nine languages: English, Deutsch, Español, Français, Italiano, 日本語, Português, 簡體中文, and 繁體中文.

Update custom language file: Click **Browse...** and specify your own custom language file to upload.

Export configuration file: Click to export all parameters for the device and user-defined scripts.

Update configuration file: Click **Browse...** to update a configuration file. Please note that the model and firmware version of the device should be the same as the configuration file. If you have set up a fixed IP or other special settings for your device, it is not suggested to update a configuration file.

Export server status report: Click to export the current server status report, such as time, logs, parameters, process status, memory status, file system status, network status, kernel message ... and so on.



#### Tips:

- If a firmware upgrade is accidentally disrupted, say, by a power outage, you still have a last resort method to restore normal operation. See the following for how to bring the camera back to work:

Applicable scenario:

- (1) Power disconnected during firmware upgrade.
- (2) Unknown reason causing abnormal LED status, and a Restore cannot recover normal working condition.

You can use the following methods to activate the camera with its backup firmware:

- (1) Press and hold down the reset button for at least one minute.
- (2) Power on the camera until the Red LED blinks rapidly.
- (3) After boot up, the firmware should return to the previous version before the camera hanged. (The procedure should take 5 to 10 minutes, longer than the normal boot-up process). When this process is completed, the LED status should return to normal.

## Media > Image Advanced Mode

This section explains how to configure the image settings of the Network Camera. It is composed of the following four columns: General settings, Image settings, Exposure, and Privacy mask.

### General settings

General settings
Image settings
Exposure
Privacy mask

**Video Settings**

Video title:

Show timestamp and video title in video and snapshots:

Position of timestamp and video title on image: Top

Timestamp and video title font-size: Small

Color:  B/W  Color

Power line frequency:  50 Hz  60 Hz

Video orientation:  Flip  Mirror

**Day/Night settings**

Switch to B/W in night mode

Turn on built-in IR illuminator in night mode

IR cut filter: Auto mode

Light sensor sensitivity: Normal

#### Video title

Show timestamp and video title in video and snapshots: Enter a name that will be displayed on the title bar of the live video as the picture shown below.

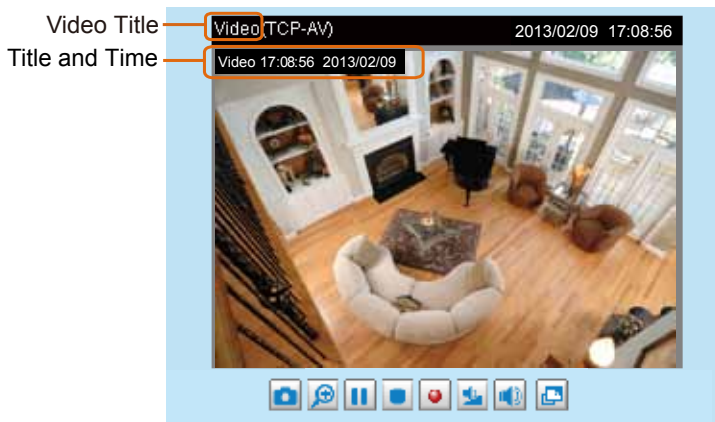

Position of timestamp and video title on image: Select to display time stamp and video title on the top or at the bottom of the video stream.

Timestamp and video title font size: Select the font size for the time stamp and title.

Color: Select to display color or black/white video streams.

Power line frequency: Set the power line frequency consistent with local utility settings to eliminate image flickering associated with fluorescent lights. Note that after the power line frequency is changed, you must disconnect and reconnect the power cord of the Network Camera in order for the new setting to take effect.

Video orientation: Flip - vertically reflect the display of the live video; Mirror - horizontally reflect the display of the live video. Select both options if the Network Camera is installed upside-down (e.g., on the ceiling) to correct the image orientation. Please note that if you have preset locations, those locations will be cleared after flip/mirror setting.

## Day/Night Settings

### Day/Night settings

- Switch to B/W in night mode
- Turn on built-in IR illuminator in night mode

IR cut filter:

Light sensor sensitivity:

### Switch to B/W in night mode

Select this to enable the Network Camera to automatically switch to Black/White during night mode.

### Turn on built-in IR illuminator in night mode

Select this to turn on the built-in IR illuminators (effective range up to 15 meters) when the camera detects low light condition and enters the night mode.

### IR cut filter

With a removable IR-cut filter, this Network Camera can automatically remove the filter to allow IR light enter the sensor during low light conditions.

- **Auto mode**  
The Network Camera automatically removes the filter by judging the level of ambient light.
- **Day mode**  
In day mode, the Network Camera switches on the IR cut filter at all times to block infrared light from reaching the sensor so that the colors will not be distorted.
- **Night mode**  
In night mode, the Network Camera switches off the IR cut filter at all times for the sensor to accept infrared light, thus helping to improve low light sensitivity.
- **Synchronize with digital input**  
The Network Camera automatically removes the IR cut filter when a Digital Input is triggered.
- **Schedule mode**  
The Network Camera switches between day mode and night mode based on a specified schedule. Enter the start and end time for day mode. Note that the time format is [hh:mm] and is expressed in 24-hour clock time. By default, the start and end time of day mode are set to 07:00 and 18:00.

### Light sensor sensitivity

Select Low, Normal, or High sensitivity for the light sensor.

## Image settings

On this page, you can tune the White balance and Image adjustment.

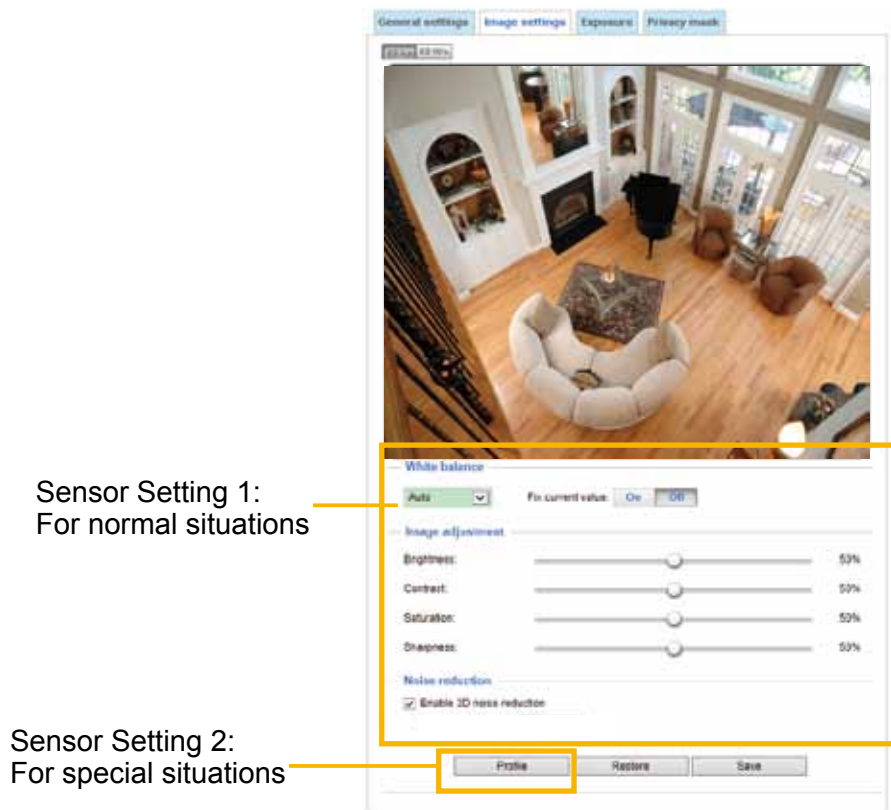

Sensor Setting 1:  
For normal situations

Sensor Setting 2:  
For special situations

**White balance:** Adjust the value for the best color temperature.

■ You may follow the steps below to adjust the white balance to the best color temperature.

1. Place a sheet of paper of white or cooler-color temperature color, such as blue, in front of the lens, then allow the Network Camera to automatically adjust the color temperature.
2. Click the **On** button to **Fix current value** and confirm the setting while the white balance is being measured.

■ You may also manually tune the color temperature by pulling the RGain and BGain slide bars.

### Image Adjustment

■ **Brightness:** Adjust the image brightness level, which ranges from -5 to +5.

■ **Contrast:** Adjust the image contrast level, which ranges from -5 to +5.

■ **Saturation:** Adjust the image saturation level, which ranges from 0% to 100%.

■ **Sharpness:** Adjust the image sharpness level, which ranges from 0% to 100%.

### Noise reduction

■ **Enable noise reduction:** Check to enable noise reduction in order to reduce noises and flickers in image. This applies to the onboard 3D Noise Reduction feature. Note that applying this function to the video channel will consume system computing power.

3D Noise Reduction is mostly applied in low-light conditions. When enabled in a low-light condition with fast moving objects, trails of after-images may occur.

**Noise reduction**

- Enable noise reduction: Check to enable noise reduction in order to reduce noises and flickers in image. This applies to the onboard 3D Noise Reduction feature. Use the pull-down menu to adjust the reduction strength. Note that applying this function to the video channel will consume system computing power.

3D Noise Reduction is mostly applied in low-light conditions. When enabled in a low-light condition with fast moving objects, trails of after-images may occur. You may then select a lower strength level or disable the function.

Note that the **Preview** button has been cancelled, all changes made to image settings is directly shown on screen. You can click **Restore** to recall the original settings without incorporating the changes. When completed with the settings on this page, click **Save** to enable the setting. You can also click on **Profile** to adjust all settings above in a pop-up window for special lighting conditions.

**Activated period**

Enable and apply this profile to

Schedule mode:

From  to  [hh:mm]

**Activated period:** Select the mode this profile to apply to: Day mode, Night mode, or Schedule mode. Please manually enter a range of time if you choose Schedule mode. Then check **Save** to take effect.

**Exposure** Advanced Mode

On this page, you can set the Measurement window, Exposure level, and Exposure mode. Detailed configurations will be automatically adjusted since the sensor library will automatically adjust the value according to the ambient light.

**Measurement window**

Full view    Custom    BLC

**Exposure control**

Exposure level:

Maximum gain control:  100%

**WDR Pro**

Enable WDR Pro

Strength:

**Measurement Window:** This function allows user to set measurement window(s) for low light compensation.

- Full view: Calculate the full range of view and offer appropriate light compensation.

- **Custom:** This option allows you to manually add a specific window as a measuring area. The measuring window refers to “weighted window” where the lighting condition within the particular area is taken into account. Camera firmware then adopts the weighted averages method to calculate the value.

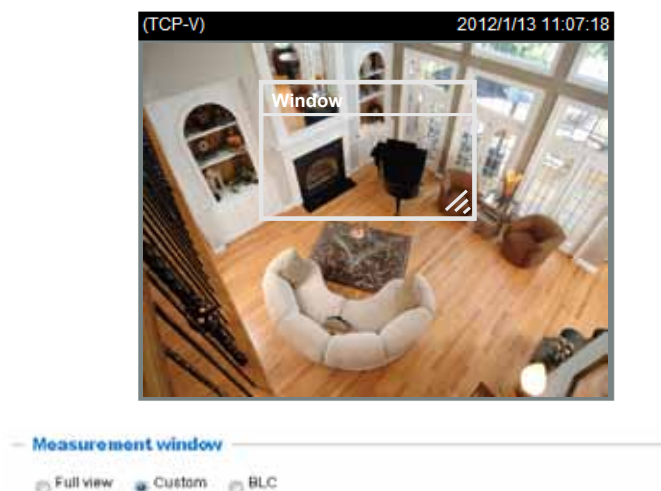

- **BLC:** When selected, a BLC window will appear on screen meaning that the center of the scene will be taken as a weighed area. This option enables light compensation for images that are too dark or too bright to recognize; for example, for the dark side of objects that is posed against bright sunlight.

#### Exposure control:

- **Exposure level:** You can manually set the Exposure level, which ranges from -2.0 to +2.0 (dark to bright). You can click and drag the semi-circular pointers on the **Exposure time** and **Gain control** slide bars to specify a range of shutter time and Gain control values within which the camera can automatically tune to an optimal imaging result. You may prefer a shorter shutter time to better capture moving objects, while a faster shutter reduces light and needs to be compensated by electrical brightness gains.
- **Maximum Gain control:** Tune the slider bar to set the Gain Control to the best image quality. Higher gain control value will generate a certain amount of noise, and that the gain control, lighting levels, and picture performance are closely related.

Firmware will then automatically tune the Gain, Exposure time, and Iris opening within the ranges you specified.

- **WDR Pro :** When enabled, you can select the strength of the WDR function. The Low, Medium, High options correspond to the level of contrast between the overly-lit area and the shaded areas. For example, the High option applies to a high contrast scenario. Note that when the exposure time is set to longer than 1/60 second, the WDR function will be disabled.

The Sensitivity option applies to the response speed to the change in bright-to-dark lighting contrast.



You can click **Restore** to recall the original settings without incorporating the changes. When completed with the settings on this page, click **Save** to enable the settings.

If you want to configure another sensor setting for day/night/schedule mode, please click **Profile** to open the Profile of exposure settings page as shown below.

**Activated period:** Select the mode this profile to apply to the Schedule mode. Please manually enter a range of time if you choose Schedule mode. Then check **Save** to take effect.

Please follow the steps below to setup a profile:

1. Check **Enable this profile**.
2. Select the applied mode: Day mode, Night mode, or Schedule mode. Please manually enter a range of time if you choose the Schedule mode.
3. Configure Exposure control settings in the following columns. Please refer to previous discussions for detailed information.
4. Click **Save** to enable the setting and click **Close** to exit the page.

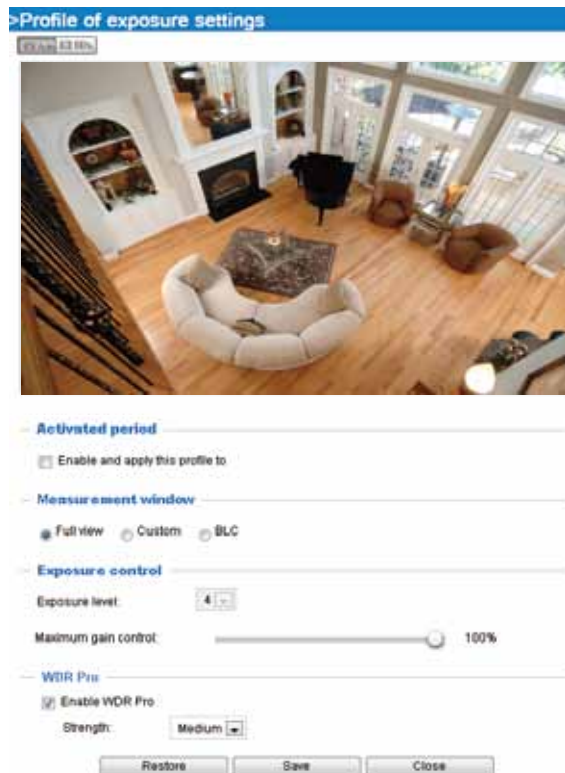

## Privacy mask **Advanced Mode**

Click **Privacy Mask** to open the settings page. On this page, you can block out sensitive zones to address privacy concerns.

Enable privacy mask



■ To set the privacy mask windows, follow the steps below:

1. Click **New** to add a new window.
2. You can use the mouse cursor to size and drag-drop the window, which is recommended to be at least twice the size of the object (height and width) you want to cover.
3. Enter a Window Name and click **Save** to enable the setting.
4. Click on the **Enable privacy mask** checkbox to enable this function.



### NOTE:

- ▶ *Up to 5 privacy mask windows can be set up on the same screen.*
- ▶ *If you want to delete the privacy mask window, please click the 'x' on the upper right corner of the window.*

## Media > Video Advanced Mode

### Stream settings

**Stream settings**

- ▶ Video settings for stream 1 [Viewing Window](#)
- ▶ Video settings for stream 2

This Network Camera supports multiple streams with frame sizes ranging from 176 x 144 to 1280x800 (FD8137H series).

The definition of multiple streams:

- Stream 1: Users can define the "Region of Interest" (viewing region) and the "Output Frame Size" (size of the live view window).
- Stream 2: The default frame size for Stream 2 is set to the 640 x 360, and the Viewing Window function is not available for stream 2.

Click **Viewing Window** to open the viewing region settings page. On this page, you can configure the **Region of Interest** and the **Output Frame Size** for different streams. For example, you can crop only a portion of the image that is of your interest, and thus save the bandwidth needed to transmit the video stream. As the picture shown below, the area of your interest in a parking lot should be the vehicles. The blue sky is of little value for the surveillance purpose.

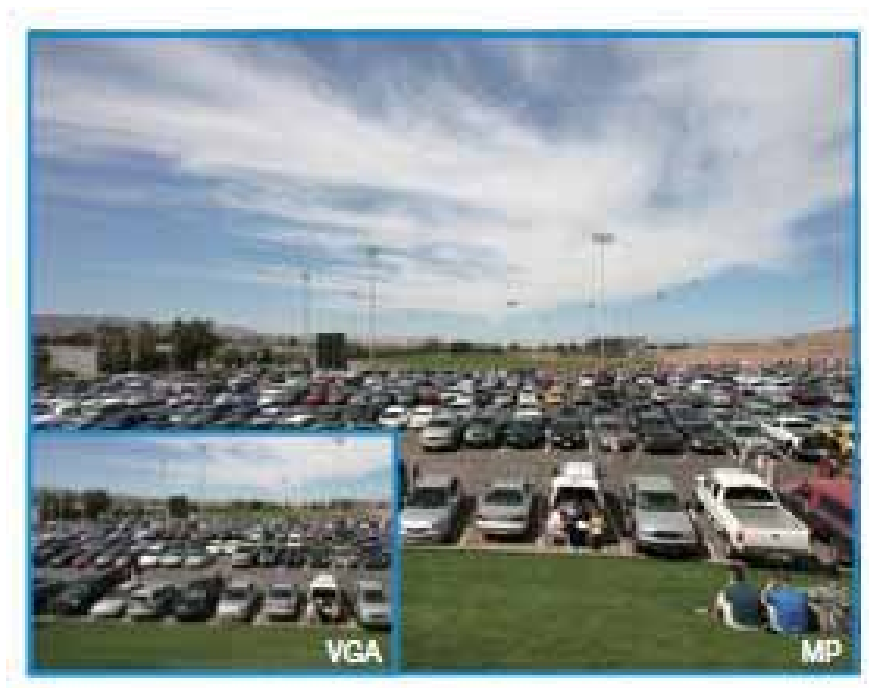

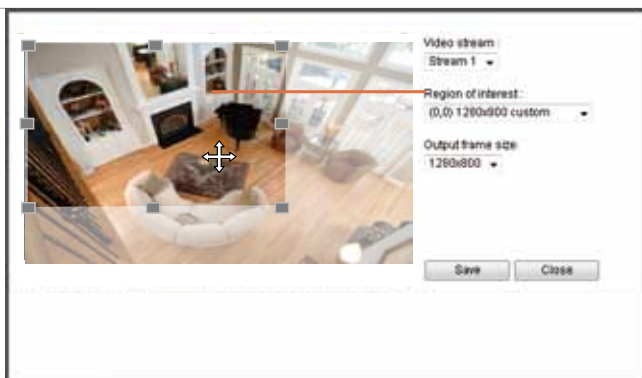

Please follow the steps below to set up those settings for a stream:

1. Select a stream for which you want to set up the viewing region.
2. Select a **Region of Interest** from the drop-down list. The floating frame, the same as the one in the Global View window on the home page, will resize accordingly. If you want to set up a customized viewing region, you can also resize and drag the floating frame to a desired position with your mouse.
3. Choose a proper **Output Frame Size** from the drop-down list according to the screen size of your monitoring device.

 **NOTE:**

► All the items in the “Region of Interest” should not be larger than the “Output Frame Size” (current maximum resolution).

■ The parameters of the multiple streams:

	Region of Interest	Output frame size
Stream 1	1280 X 800 ~ 176 x 144 (Selectable)	1280 X 800 ~ 176 x 144 (Selectable)
Stream 2	1280 X 800 ~ 176 x 144 (Selectable)	Fixed

When completed with the settings in the Viewing Window, click **Save** to enable the settings and click **Close** to exit the window. The selected **Output Frame Size** will immediately be applied to the **Frame size** of each video stream. Then you can go back to the home page to test the e-PTZ function. For more information about the e-PTZ function, please refer to page 90.

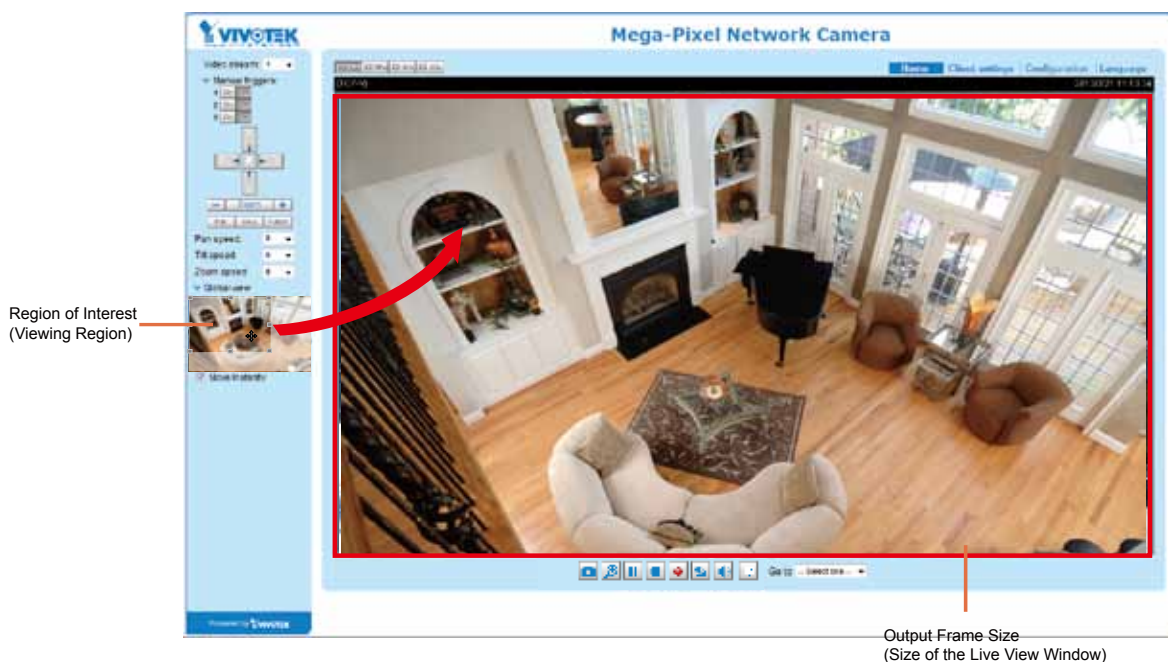

Click the stream item to display the detailed information. The maximum frame size will follow your settings in the above Viewing Window sections.

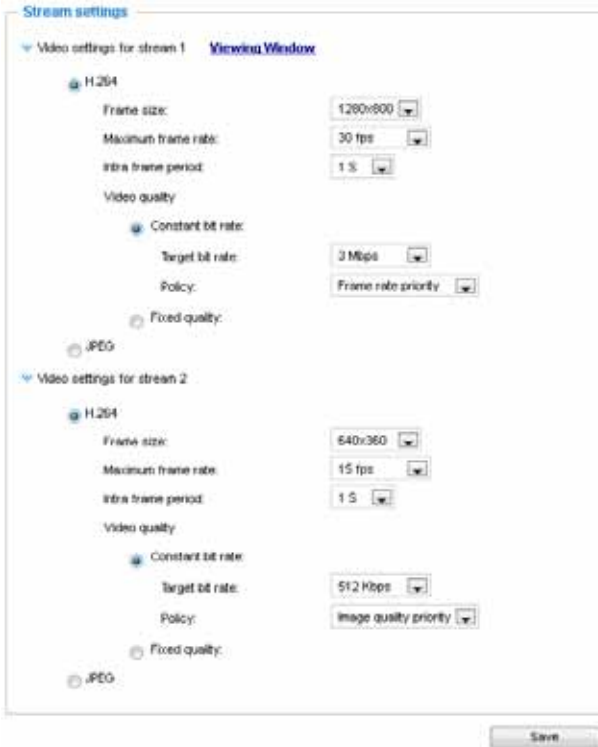

This Network Camera offers real-time H.264 and MJPEG compression standards (Dual Codec) for real-time viewing. If the **H.264** mode is selected, the video is streamed via RTSP protocol. There are several parameters through which you can adjust the video performance:

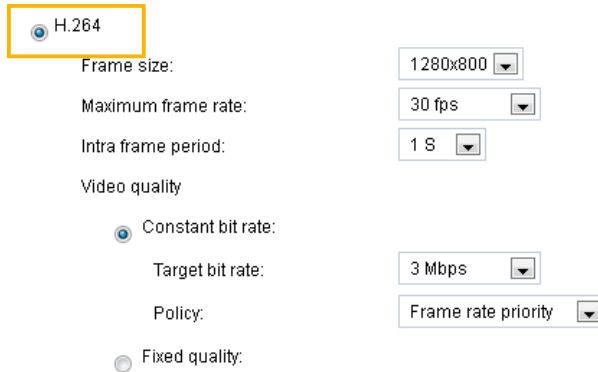

■ **Frame size**

You can set up different video resolutions for different viewing devices. For example, set a smaller frame size and lower bit rate for remote viewing on mobile phones and a larger video size and a higher bit rate for live viewing on web browsers. Note that a larger frame size takes up more bandwidth.

■ **Maximum frame rate**

This limits the maximum refresh frame rate per second. Set the frame rate higher for smoother video quality and for recognizing moving objects in the field of view.

If the power line frequency is set to 50Hz, the frame rates are selectable at 1fps, 2fps, 3fps, 5fps, 8fps, 10fps, 15fps, 20fps, and 25fps. If the power line frequency is set to 60Hz, the frame rates are selectable at 1fps, 2fps, 3fps, 5fps, 8fps, 10fps, 15fps, 20fps, 25fps, and 30fps. You can also select **Customize** and manually enter a value.

The frame rate will decrease if you select a higher resolution.

■ **Intra frame period**

Determine how often for firmware to plant an I frame. The shorter the duration, the more likely you will get better video quality, but at the cost of higher network bandwidth consumption. Select the intra frame period from the following durations: 1/4 second, 1/2 second, 1 second, 2 seconds, 3 seconds, and 4 seconds.

■ **Video quality**

- **Constant bit rate:** A complex scene generally produces a larger file size, meaning that higher bandwidth will be needed for data transmission. The bandwidth utilization is configurable to match a selected level, resulting in mutable video quality performance. The bit rates are selectable at the following rates: 20Kbps, 30Kbps, 40Kbps, 50Kbps, 64Kbps, 128Kbps, 256Kbps, 512Kbps, 768Kbps, 1Mbps, 2Mbps, 3Mbps, 4Mbps, 6Mbps, and 8Mbps. You can also select **Customize** and manually enter a value.

- **Target bit rate:** select a bit rate from the pull-down menu. The bit rate ranges from 20kbps to a maximum of 8Mbps. The bit rate then becomes the Average or Upper bound bit rate number. The Network Camera will strive to deliver video streams around or within the bit rate limitation you impose.

- **Policy:** If Frame Rate Priority is selected, the Network Camera will try to maintain the frame rate per second performance, while the image quality will be compromised. If Image quality priority is selected, the Network Camera may drop some video frames in order to maintain image quality.

- **Fixed quality:** On the other hand, if **Fixed quality** is selected, all frames are transmitted with the same quality; bandwidth utilization is therefore unpredictable. The video quality can be adjusted to the following settings: Medium, Standard, Good, Detailed, and Excellent. You can also select **Customize** and manually enter a value.

- **Maximum bit rate:** With the guaranteed image quality, you might still want to place a bit rate limitation to control the size of video streams for bandwidth and storage concerns. The configurable bit rate starts from 1Mbps to 40Mbps.

You may also manually enter a bit rate number by selecting the **Customized** option.

If **JPEG** mode is selected, the Network Camera sends consecutive JPEG images to the client, producing a moving effect similar to a filmstrip. Every single JPEG image transmitted guarantees the same image quality, which in turn comes at the expense of variable bandwidth usage. Because the media contents are a combination of JPEG images, no audio data is transmitted to the client. There are three parameters provided in MJPEG mode to control the video performance:

JPEG

Frame size:

Maximum frame rate:

Video quality

Constant bit rate:

Fixed quality:

Quality:

Maximum bit rate:

#### ■ Frame size

You can set up different video resolution for different viewing devices. For example, set a smaller frame size and lower bit rate for remote viewing on mobile phones and a larger video size and a higher bit rate for live viewing on web browsers. Note that a larger frame size takes up more bandwidth.

#### ■ Maximum frame rate

This limits the maximum refresh frame rate per second. Set the frame rate higher for smoother video quality.

If the power line frequency is set to 50Hz, the frame rates are selectable at 1fps, 2fps, 3fps, 5fps, 8fps, 10fps, 15fps, 20fps, and 25fps. If the power line frequency is set to 60Hz, the frame rates are selectable at 1fps, 2fps, 3fps, 5fps, 8fps, 10fps, 15fps, 20fps, 25fps, and 30fps. You can also select **Customize** and manually enter a value. The frame rate will decrease if you select a higher resolution.

#### ■ Video quality

Refer to the previous page setting an average or upper bound threshold for controlling the bandwidth consumed for transmitting motion jpegs. The configuration method is identical to that for MPEG4 and H.264.

For Constant Bit Rate and other settings, refer to the previous page for details.



#### NOTE:

- ▶ *Video quality and fixed quality refers to the **compression rate**, so a lower value will produce higher quality.*
- ▶ *Converting high-quality video may significantly increase the CPU loading, and you may encounter streaming disconnection or video loss while capturing a complicated scene. In the event of occurrence, we suggest you customize a lower video resolution or reduce the frame rate to obtain smooth video.*



## Media > Audio

### Audio Settings

Media > Audio

**Audio settings**

Mute

Internal microphone input gain:  65%

Audio type

G.711: pcmu

G.726: 16 Kbps

Save

**Mute:** Select this option to disable audio transmission from the Network Camera to all clients. Note that if muted, no audio data will be transmitted even if audio transmission is enabled on the Client Settings page. In that case, the following message is displayed:

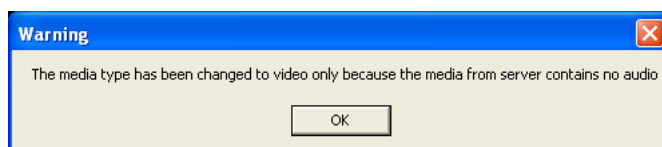

**Internal microphone input gain:** Select the gain of the internal audio input according to ambient conditions. Adjust the gain from 100% (most sensitive) to 0% (least sensitive).

**Audio type:** **Advanced Mode**.

- G.711 provides good sound quality and requires about 64Kbps. Select the operation mode as pcmu ( $\mu$ -Law) or pcma (A-Law) mode.
- G.726 is a speech codec standard covering voice transmission at rates of 16, 24, 32, and 40kbps.

When completed with the settings on this page, click **Save** to enable the settings.

## Network > General settings

This section explains how to configure a wired network connection for the Network Camera.

### Network Type

### LAN

Select this option when the Network Camera is deployed on a local area network (LAN) and is intended to be accessed by local computers. The default setting for the Network Type is LAN. Please remember to click on the **Save** button when you complete the Network setting.

Get IP address automatically: Select this option to obtain an available dynamic IP address assigned by the DHCP server each time the camera is connected to the LAN.

Use fixed IP address: Select this option to manually assign a static IP address to the Network Camera.

1. You can make use of VIVOTEK Installation Wizard 2 on the software CD to easily set up the Network Camera on LAN. Please refer to Software Installation on page 16 for details.
2. Enter the Static IP, Subnet mask, Default router, and Primary DNS provided by your ISP or network administrator.

Subnet mask: This is used to determine if the destination is in the same subnet. The default value is "255.255.255.0".

Default router: This is the gateway used to forward frames to destinations in a different subnet. Invalid router setting will disable the transmission to destinations across different subnets.

**Primary DNS:** The primary domain name server that translates hostnames into IP addresses.

**Secondary DNS:** Secondary domain name server that backups the Primary DNS.

**Primary WINS server:** The primary WINS server that maintains the database of computer names and IP addresses.

**Secondary WINS server:** The secondary WINS server that maintains the database of computer names and IP addresses.

**Enable UPnP presentation:** Select this option to enable UPnP™ presentation for your Network Camera so that whenever a Network Camera is presented to the LAN, the shortcuts to connected Network Cameras will be listed in My Network Places. You can click the shortcut to link to the web browser. Currently, UPnP™ is supported by Windows XP or later. Note that to utilize this feature, please make sure the UPnP™ component is installed on your computer.

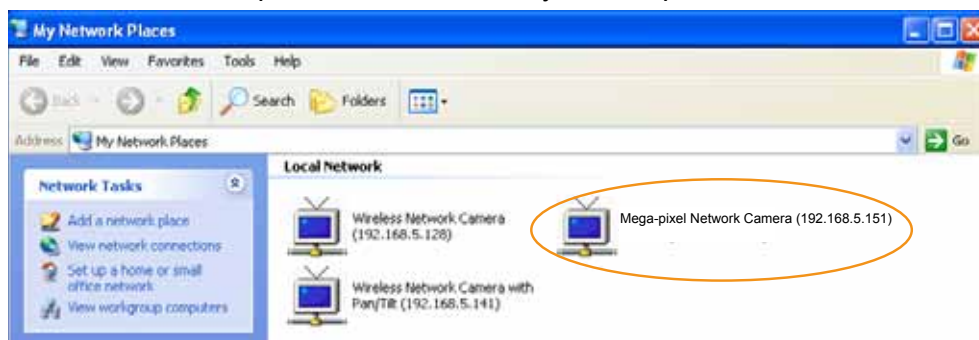

**Enable UPnP port forwarding:** To access the Network Camera from the Internet, select this option to allow the Network Camera to open ports automatically on the router so that video streams can be sent out from a LAN. To utilize of this feature, make sure that your router supports UPnP™ and it is activated.

### PPPoE (Point-to-point over Ethernet)

Select this option to configure your Network Camera to make it accessible from anywhere as long as there is an Internet connection. Note that to utilize this feature, it requires an account provided by your ISP.

Follow the steps below to acquire your Network Camera's public IP address.

1. Set up the Network Camera on the LAN.
2. Go to Configuration > Event > Event settings > Add server (please refer to Add server on page 97) to add a new email or FTP server.
3. Go to Configuration > Event > Event settings > Add media (please refer to Add media on page 102).

Select System log so that you will receive the system log in TXT file format which contains the Network Camera's public IP address in your email or on the FTP server.

4. Go to Configuration > Network > General settings > Network type. Select PPPoE and enter the user name and password provided by your ISP. Click **Save** to enable the setting.

**Network type**

LAN

PPPoE

User name:

Password:

Confirm password:

Enable IPv6

5. The Network Camera will reboot.

6. Disconnect the power to the Network Camera; remove it from the LAN environment.

**NOTE:**

- ▶ If the default ports are already used by other devices connected to the same router, the Network Camera will select other ports for the Network Camera.
- ▶ If UPnP™ is not supported by your router, you will see the following message:  
**Error: Router does not support UPnP port forwarding.**
- ▶ Steps to enable the UPnP™ user interface on your computer:  
Note that you must log on to the computer as a system administrator to install the UPnP™ components.

1. Go to Start, click **Control Panel**, then click **Add or Remove Programs**.

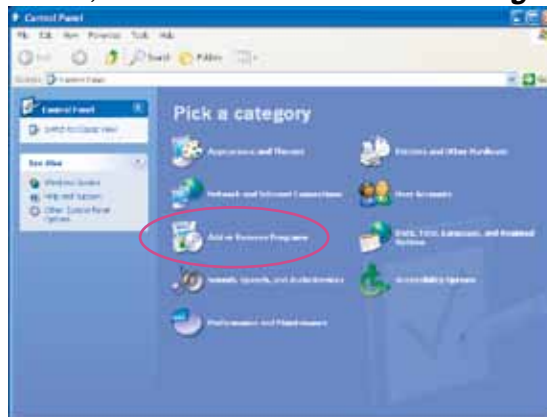

2. In the Add or Remove Programs dialog box, click **Add/Remove Windows Components**.

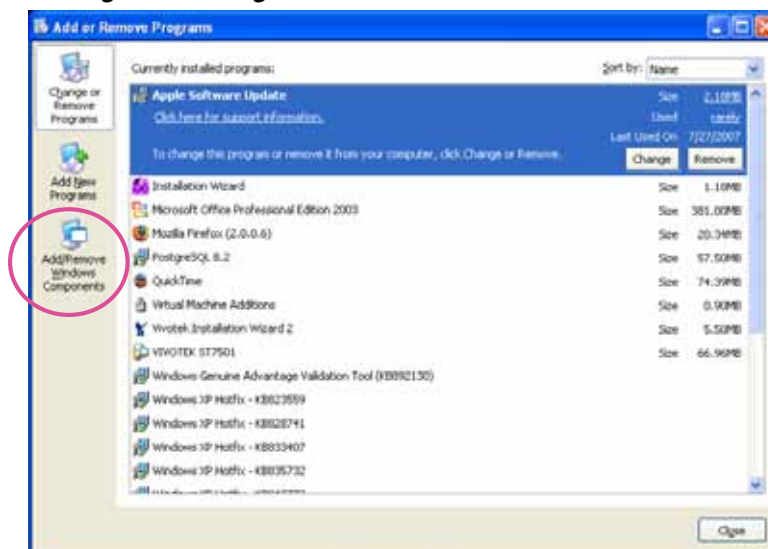

3. In the Windows Components Wizard dialog box, select **Networking Services** and click **Details**.

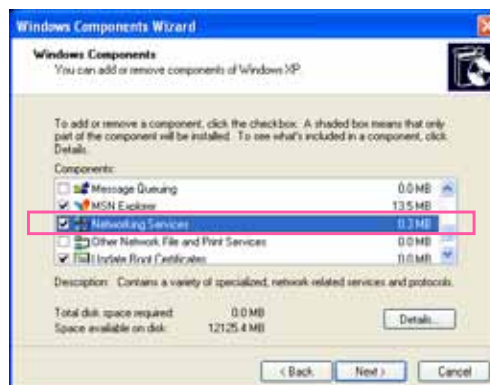

4. In the Networking Services dialog box, select **Universal Plug and Play** and click **OK**.

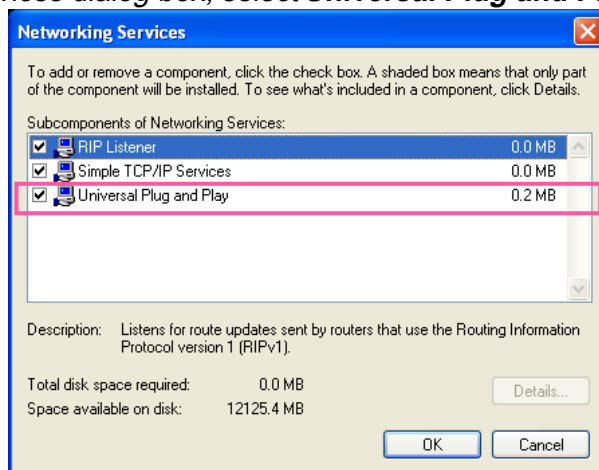

5. Click **Next** in the following window.

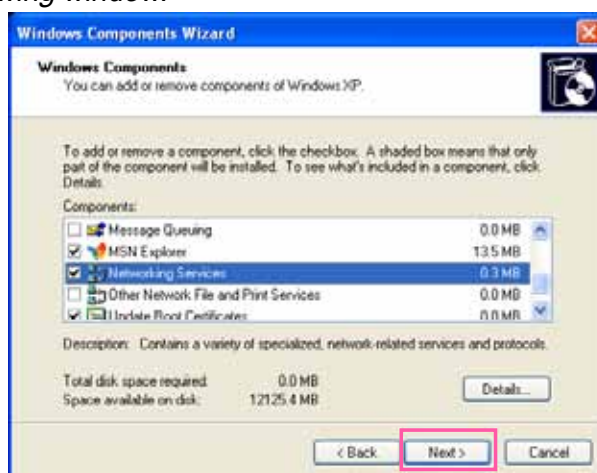

6. Click **Finish**. UPnP™ is enabled.

► **How does UPnP™ work?**

UPnP™ networking technology provides automatic IP configuration and dynamic discovery of devices added to a network. Services and capabilities offered by networked devices, such as printing and file sharing, are available among each other without the need for cumbersome network configuration. In the case of Network Cameras, you will see Network Camera shortcuts under My Network Places.

► **Enabling UPnP port forwarding allows the Network Camera to open a secondary HTTP port on the router-not HTTP port-meaning that you have to add the secondary HTTP port number to the Network Camera's public address in order to access the Network Camera from the Internet. For example, when the HTTP port is set to 80 and the secondary HTTP port is set to 8080, refer to the list below for the Network Camera's IP address.**

From the Internet	In LAN
http://203.67.124.123:8080	http://192.168.4.160 or http://192.168.4.160:8080

► **If the PPPoE settings are incorrectly configured or the Internet access is not working, restore the Network Camera to factory default; please refer to Restore on page 44 for details. After the Network Camera is reset to factory default, it will be accessible on the LAN.**

### Enable IPv6

Select the Enable IPv6 checkbox and click **Save** to enable IPv6 settings. Please note that this only works if your network environment and hardware equipment support IPv6. The browser should be Microsoft® Internet Explorer 7 or 8, Mozilla Firefox 13.0 or above.

**Network type**

LAN

PPPoE

User name:

Password:

Confirm password:

Enable IPv6

[IPv6 information](#)

Manually setup the IP address

When IPv6 is enabled, by default, the network camera will listen to router advertisements and be assigned with a link-local IPv6 address accordingly.

IPv6 Information: Click this button to obtain the IPv6 information as shown below.

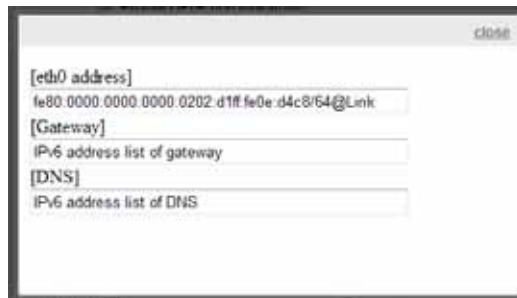

If your IPv6 settings are successful, the IPv6 address list will be listed in the pop-up window. The IPv6 address will be displayed as follows:

### Refers to Ethernet

<b>[eth0 address]</b>	<code>2001:0c08:2500:0002:0202:d1ff:fe04:65f4/64@Global</code>	<b>Link-global IPv6 address/network mask</b>
	<code>fe80:0000:0000:0000:0202:d1ff:fe04:65f4/64@Link</code>	<b>Link-local IPv6 address/network mask</b>
<b>[Gateway]</b>	<code>fe80::211:d8ff:fea2:1a2b</code>	
<b>[DNS]</b>	<code>2010:05c0:978d::</code>	

Please follow the steps below to link to an IPv6 address:

1. Open your web browser.
2. Enter the link-global or link-local IPv6 address in the address bar of your web browser.
3. The format should be:



4. Press **Enter** on the keyboard or click **Refresh** button to refresh the webpage.  
For example:

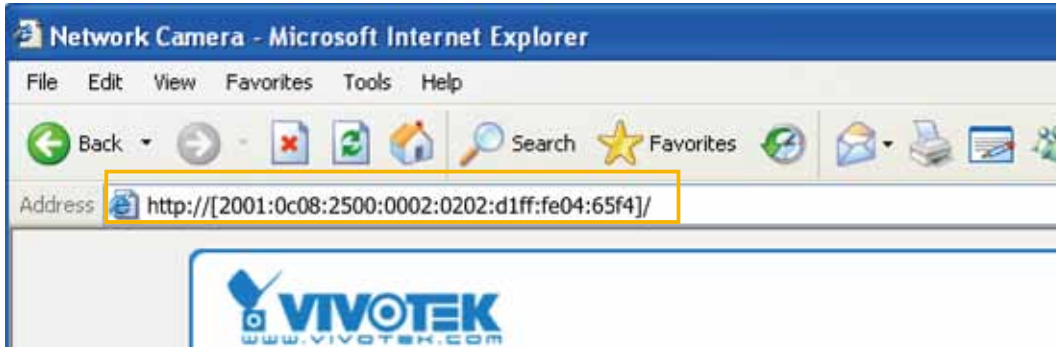

**NOTE:**

- ▶ If you have a Secondary HTTP port (the default value is 8080), you can also link to the webpage using the following address format: (Please refer to **HTTP streaming** on page 67 for detailed information.)



- ▶ If you choose PPPoE as the Network Type, the [PPP0 address] will be displayed in the IPv6 information column as shown below.

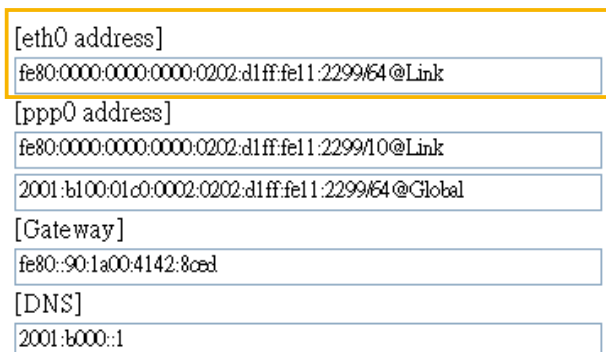

**Manually setup the IP address:** Select this option to manually configure IPv6 settings if your network environment does not have DHCPv6 server and router advertisements-enabled routers. If you check this item, the following blanks will be displayed for you to enter the corresponding information:



Enable IPv6**IPv6 information** Manually setup the IP addressOptional IP address / Prefix length  / 64Optional default router Optional primary DNS **Port**

port	
HTTPS port:	<input type="text" value="443"/>
FTP port:	<input type="text" value="21"/>

**HTTPS port:** By default, the HTTPS port is set to 443. It can also be assigned to another port number between 1025 and 65535.

**FTP port:** The FTP server allows the user to save recorded video clips. You can utilize VIVOTEK's Installation Wizard 2 to upgrade the firmware via FTP server. By default, the FTP port is set to 21. It also can be assigned to another port number between 1025 and 65535.

## Network > Streaming protocols Advanced Mode

### HTTP streaming

To utilize HTTP authentication, make sure that you have set a password for the Network Camera first; please refer to Security > User account on page 77 for details.

HTTP streaming
RTSP streaming

Authentication: basic

HTTP port: 80

Secondary HTTP port: 8080

Access name for stream 1: video.mjpg

Access name for stream 2: video2.mjpg

Access name for stream 3: videoany.mjpg

Save

**Authentication:** Depending on your network security requirements, the Network Camera provides two types of security settings for an HTTP transaction: basic and digest.

If **basic** authentication is selected, the password is sent in plain text format and there can be potential risks of being intercepted. If **digest** authentication is selected, user credentials are encrypted using MD5 algorithm and thus provide better protection against unauthorized accesses.

**HTTP port / Secondary HTTP port:** By default, the HTTP port is set to 80 and the secondary HTTP port is set to 8080. They can also be assigned to another port number between 1025 and 65535. If the ports are incorrectly assigned, the following warning messages will be displayed:

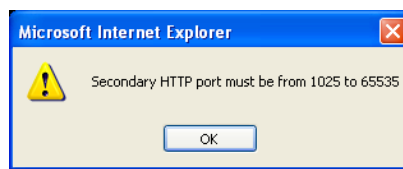

To access the Network Camera on the LAN, both the HTTP port and secondary HTTP port can be used to access the Network Camera. For example, when the HTTP port is set to 80 and the secondary HTTP port is set to 8080, refer to the list below for the Network Camera's IP address.

#### On the LAN

http://192.168.4.160 or  
http://192.168.4.160:8080

**Access name for stream 1 ~ 3:** This Network camera supports multiple streams simultaneously. The access name is used to identify different video streams. Users can click **Media > Video > Stream settings** to set up the video quality of linked streams. For more information about how to set up the video quality, please refer to Stream settings on page 54.

When using **Mozilla Firefox** to access the Network Camera and the video mode is set to JPEG, users will receive video comprised of continuous JPEG images. This technology, known as "server push", allows the Network Camera to feed live pictures to Mozilla Firefox.

URL command -- <http://<ip address>:<http port>/<access name for stream 1~3>>

For example, when the Access name for [stream 2](#) is set to [video2.mjpg](#):

1. Launch Mozilla Firefox or Netscape.
2. Type the above URL command in the address bar. Press **Enter**.
3. The JPEG images will be displayed in your web browser.

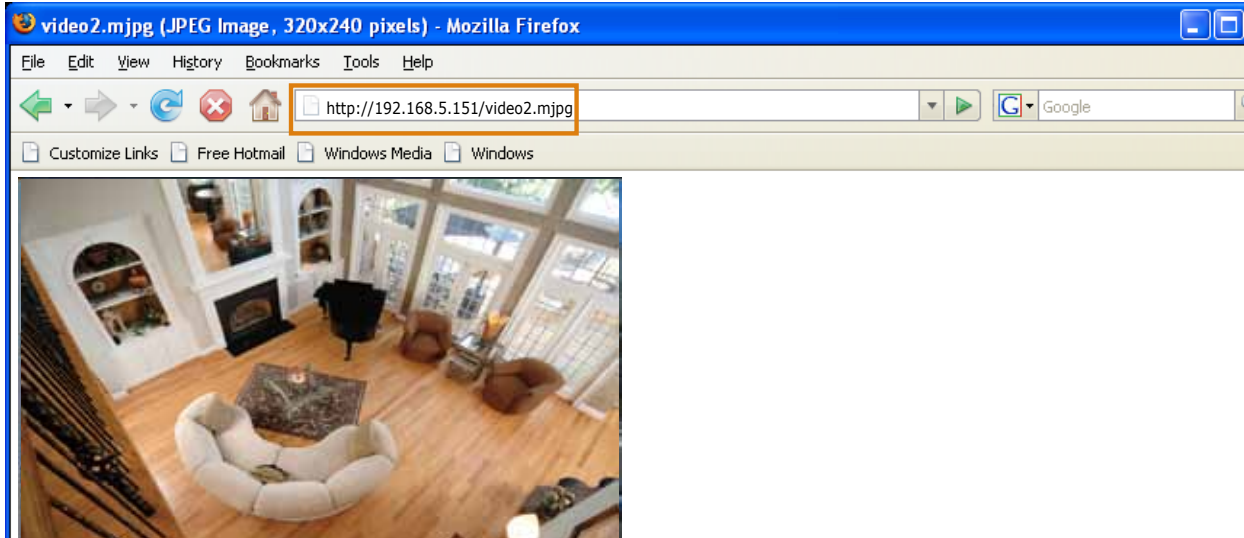

**NOTE:**

► *Microsoft® Internet Explorer does not support server push technology; therefore, you will not be able to access a video stream using <http://<ip address>:<http port>/<access name for stream 1~3>>.*

**RTSP Streaming**

To utilize RTSP streaming authentication, make sure that you have set a password for controlling the access to video stream first. Please refer to Security > User account on page 77 for details.

HTTP streaming	RTSP streaming
Authentication:	disable
Access name for stream 1:	live.sdp
Access name for stream 2:	live2.sdp
Access name for stream 3:	liveany.sdp
RTSP port:	554
RTP port for video:	5556
RTCP port for video:	5557
RTP port for audio:	5558
RTCP port for audio:	5559
<p>➤ Multicast settings for stream 1</p> <p>➤ Multicast settings for stream 2</p>	
<input type="button" value="Save"/>	

**Authentication:** Depending on your network security requirements, the Network Camera provides three types of security settings for streaming via RTSP protocol: disable, basic, and digest. If **basic** authentication is selected, the password is sent in plain text format, but there can be potential risks of it being intercepted. If **digest** authentication is selected, user credentials are encrypted using MD5 algorithm, thus providing better protection against unauthorized access. The availability of the RTSP streaming for the three authentication modes is listed below:

	Quick Time player	VLC
Disable	O	O
Basic	O	O
Digest	O	X

**Access name for stream 1 ~ 3:** This Network camera supports multiple streams simultaneously. The access name is used to differentiate the streaming source.

If you want to use an **RTSP player** to access the Network Camera, you have to set the video mode to **H.264** and use the following RTSP URL command to request transmission of the streaming data. **rtsp://<ip address>:<rtsp port>/<access name for stream 1 to 3>**

For example, when the access name for **stream 1** is set to **live.sdp**:

1. Launch an RTSP player.
2. Choose File > Open URL. A URL dialog box will pop up.
3. Type the above URL command in the text box.
4. The live video will be displayed in your player as shown below.

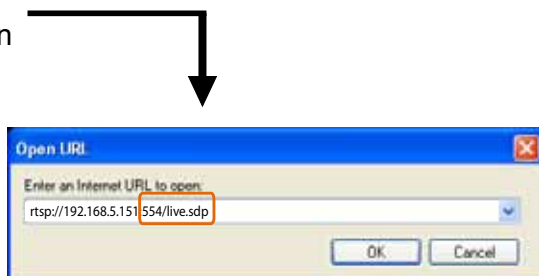

**RTSP port /RTP port for video and RTCP port for video**

- RTSP (Real-Time Streaming Protocol) controls the delivery of streaming media. By default, the port number is set to 554.
- The RTP (Real-time Transport Protocol) is used to deliver video data to the clients. By default, the RTP port for video is set to 5556.
- The RTCP (Real-time Transport Control Protocol) allows the Network Camera to transmit the data by monitoring the Internet traffic volume. By default, the RTCP port for video is set to 5557.

The ports can be changed to values between 1025 and 65535. The RTP port must be an even number and the RTCP port is the RTP port number plus one, and thus is always an odd number. When the RTP port changes, the RTCP port will change accordingly.

If the RTP ports are incorrectly assigned, the following warning message will be displayed:

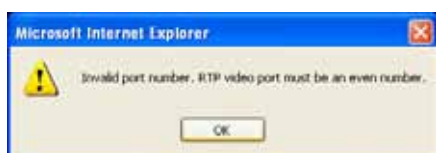

**Multicast settings for stream 1 ~ 2:** Click the items to display the detailed configuration information. Select the Always multicast option to enable multicast for stream 1 ~ 2.

Multicast settings for stream 1

Always multicast

Multicast group address:

Multicast video port:

Multicast RTCP video port:

Multicast audio port:

Multicast RTCP audio port:

Multicast TTL [1~255]:

Multicast settings for stream 2

Always multicast

Multicast group address:

Multicast video port:

Multicast RTCP video port:

Multicast audio port:

Multicast RTCP audio port:

Multicast TTL [1~255]:

Unicast video transmission delivers a stream through point-to-point transmission; multicast, on the other hand, sends a stream to the multicast group address and allows multiple clients to acquire the stream at the same time by requesting a copy from the multicast group address. Therefore, enabling multicast can effectively save Internet bandwidth.

The ports can be changed to values between 1025 and 65535. The multicast RTP port must be an even number and the multicast RTCP port number is the multicast RTP port number plus one, and thus is always odd. When the multicast RTP port changes, the multicast RTCP port will change accordingly.

If the multicast RTP video ports are incorrectly assigned, the following warning message will be displayed:

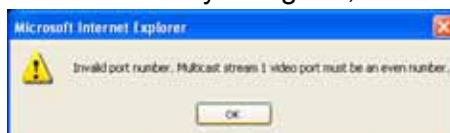

**Multicast TTL [1~255]:** The multicast TTL (Time To Live) is the value that tells the router the range a packet can be forwarded.

Initial TTL	Scope
0	Restricted to the same host
1	Restricted to the same subnetwork
32	Restricted to the same site
64	Restricted to the same region
128	Restricted to the same continent
255	Unrestricted in scope

## Network > DDNS

This section explains how to configure the dynamic domain name service for the Network Camera. DDNS is a service that allows your Network Camera, especially when assigned with a dynamic IP address, to have a fixed host and domain name.

### Express link

Express Link is a free service provided by VIVOTEK server, which allows users to register a domain name for a network device. One URL can only be mapped to one MAC address. This service will examine if the host name is valid and automatically open a port on your router. If using DDNS, the user has to manually configure UPnP port forwarding. Express Link is more convenient and easier to set up.

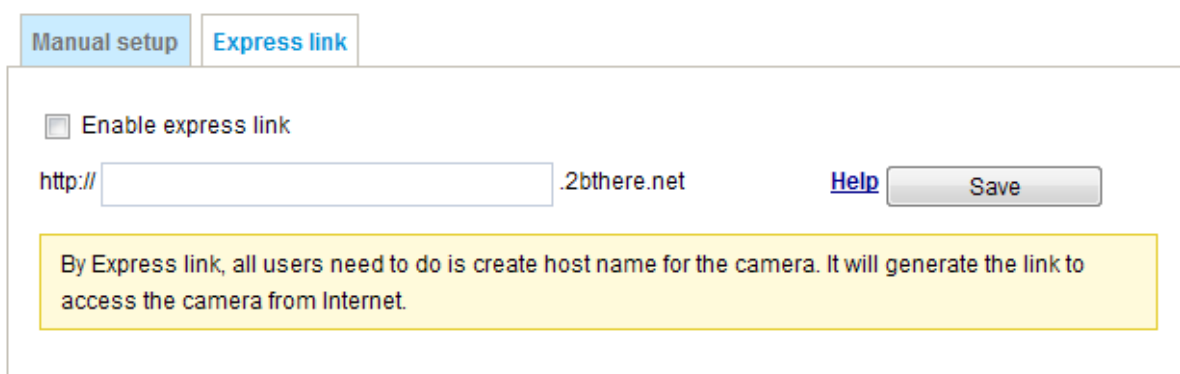

Please follow the steps below to enable Express Link:

1. Make sure that your router supports UPnP port forwarding and it is activated.
2. Check **Enable express link**.
3. Enter a host name for the network device and click **Save**. If the host name has been used by another device, a warning message will show up. If the host name is valid, it will display a message as shown below.

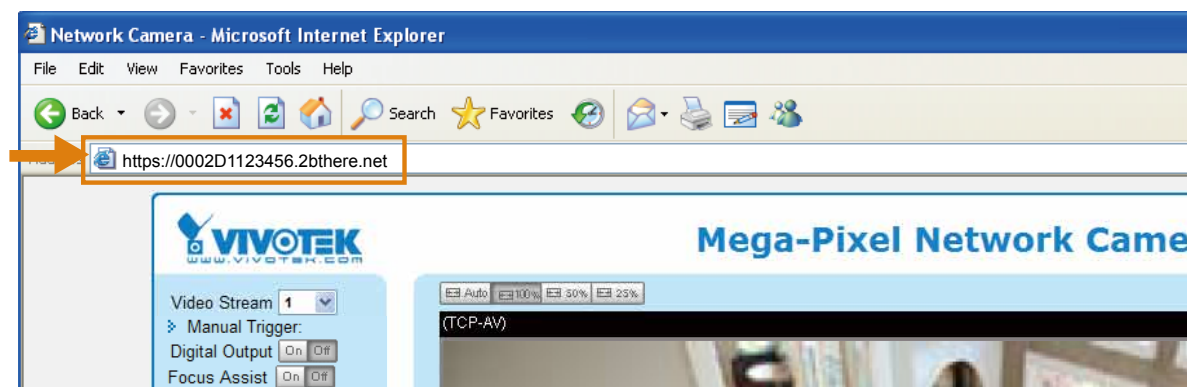
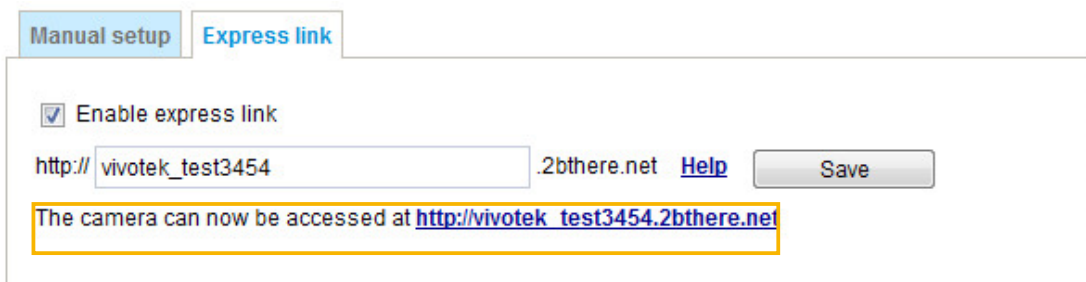

## Manual setup

### DDNS: Dynamic domain name service

**DDNS: Dynamic domain name service**

Enable DDNS:

Provider:

Host name:

User name:

Password:

**Enable DDNS:** Select this option to enable the DDNS setting.

**Provider:** Select a DDNS provider from the provider drop-down list. VIVOTEK offers **Safe100.net**, a free dynamic domain name service, to VIVOTEK customers. It is recommended that you register **Safe100.net** to access VIVOTEK's Network Cameras from the Internet. Additionally, we offer other DDNS providers, such as Dyn dns.org(Dynamic), Dyn dns.org(Custom), TZO.com, DHS.org, CustomSafe100, dyn-interfree.it. Note that before utilizing this function, please apply for a dynamic domain account first.

#### ■ Safe100.net

1. In the DDNS column, select **Safe100.net** from the drop-down list. Click **I accept** after reviewing the terms of the Service Agreement.
2. In the Register column, fill in the Host name (xxxx.safe100.net), Email, Key, and Confirm Key, and click **Register**. After a host name has been successfully created, a success message will be displayed in the DDNS Registration Result column.

**Register**

Host name:

Email:

Key:

Confirm key:

To apply for a domain name for the camera, or to modify the previously registered information, fill in the following fields and then click "Register".

**DDNS Registration Result:**

[Register] Successfully Your account information has been mailed to registered e-mail address

Upon successful registration, you can click **copy** to automatically upload relevant information to the DDNS form or you can manually fill it in. Then, click "Save" to save new settings.

3. Click **Copy** and all the registered information will automatically be uploaded to the corresponding fields in the DDNS column at the top of the page as seen in the picture.



**DDNS: Dynamic domain name service**

Enable DDNS:

Provider:

Host name:  [\* .safe100.net]

Email:

Key:

---

**Register**

Host name:

Email:

Key:

Confirm key:

To apply for a domain name for the camera, or to modify the previously registered information, fill in the following fields and then click "Register".

DDNS Registration Result:

Upon successful registration, you can click [copy](#) to automatically upload relevant information to the DDNS form or you can manually fill it in. Then, click "Save" to save new settings.

4. Select Enable DDNS and click **Save** to enable the setting.

#### ■ CustomSafe100

VIVOTEK offers documents to establish a CustomSafe100 DDNS server for distributors and system integrators. You can use CustomSafe100 to register a dynamic domain name if your distributor or system integrators offer such services.

1. In the DDNS column, select CustomSafe100 from the drop-down list.
2. In the Register column, fill in the Host name, Email, Key, and Confirm Key; then click **Register**. After a host name has been successfully created, you will see a success message in the DDNS Registration Result column.
3. Click **Copy** and all for the registered information will be uploaded to the corresponding fields in the DDNS column.
4. Select Enable DDNS and click **Save** to enable the setting.

**Forget key:** Click this button if you have forgotten the key to Safe100.net or CustomSafe100. Your account information will be sent to your email address.

Refer to the following links to apply for a dynamic domain account when selecting other DDNS providers:

- [Dyndns.org\(Dynamic\) / Dyndns.org\(Custom\)](http://www.dyndns.com/): visit <http://www.dyndns.com/>
- [dyn-interfree.it](http://dyn-interfree.it/): visit <http://dyn-interfree.it/>

## Network > QoS (Quality of Service) Advanced Mode

Quality of Service refers to a resource reservation control mechanism, which guarantees a certain quality to different services on the network. Quality of service guarantees are important if the network capacity is insufficient, especially for real-time streaming multimedia applications. Quality can be defined as, for instance, a maintained level of bit rate, low latency, no packet dropping, etc.

The following are the main benefits of a QoS-aware network:

- The ability to prioritize traffic and guarantee a certain level of performance to the data flow.
- The ability to control the amount of bandwidth each application may use, and thus provide higher reliability and stability on the network.

### Requirements for QoS

To utilize QoS in a network environment, the following requirements must be met:

- All network switches and routers in the network must include support for QoS.
- The network video devices used in the network must be QoS-enabled.

### QoS models

#### CoS (the VLAN 802.1p model)

IEEE802.1p defines a QoS model at OSI Layer 2 (Data Link Layer), which is called CoS, Class of Service. It adds a 3-bit value to the VLAN MAC header, which indicates the frame priority level from 0 (lowest) to 7 (highest). The priority is set up on the network switches, which then use different queuing disciplines to forward the packets.

Below is the setting column for CoS. Enter the **VLAN ID** of your switch (0~4095) and choose the priority for each application (0~7).

**CoS**

Enable CoS

VLAN ID:

Live video:  ▼

Event/Alarm:  ▼

Management:  ▼

If you assign Video the highest level, the switch will handle video packets first.



#### NOTE:

- ▶ A VLAN Switch (802.1p) is required. Web browsing may fail if the CoS setting is incorrect.
- ▶ The Class of Service technologies do not guarantee a level of service in terms of bandwidth and delivery time; they offer a "best-effort." Users can think of CoS as "coarsely-grained" traffic control and QoS as "finely-grained" traffic control.
- ▶ Although CoS is simple to manage, it lacks scalability and does not offer end-to-end guarantees since it is based on L2 protocol.

### QoS/DSCP (the DiffServ model)

DSCP-ECN defines QoS at Layer 3 (Network Layer). The Differentiated Services (DiffServ) model is based on packet marking and router queuing disciplines. The marking is done by adding a field to the IP header, called the DSCP (Differentiated Services Codepoint). This is a 6-bit field that provides 64 different class IDs. It gives an indication of how a given packet is to be forwarded, known as the Per Hop Behavior (PHB). The PHB describes a particular service level in terms of bandwidth, queueing theory, and dropping (discarding the packet) decisions. Routers at each network node classify packets according to their DSCP value and give them a particular forwarding treatment; for example, how much bandwidth to reserve for it.

Below are the setting options of DSCP (DiffServ Codepoint). Specify the DSCP value for each application (0~63).

#### QoS/DSCP

Enable QoS/DSCP

Live video:	<input type="text" value="0"/>
Event/Alarm:	<input type="text" value="0"/>
Management:	<input type="text" value="0"/>

Save

## Network > SNMP (Simple Network Management Protocol) Advanced Mode

This section explains how to use the SNMP on the network camera. The Simple Network Management Protocol is an application layer protocol that facilitates the exchange of management information between network devices. It helps network administrators to remotely manage network devices and find, solve network problems with ease.

- The SNMP consists of the following three key components:
  1. Manager: Network-management station (NMS), a server which executes applications that monitor and control managed devices.
  2. Agent: A network-management software module on a managed device which transfers the status of managed devices to the NMS.
  3. Managed device: A network node on a managed network. For example: routers, switches, bridges, hubs, computer hosts, printers, IP telephones, network cameras, web server, and database.

Before configuring SNMP settings on the this page, please enable your NMS first.

### SNMP Configuration

#### Enable SNMPv1, SNMPv2c

Select this option and enter the names of Read/Write community and Read Only community according to your NMS settings.

Enable SNMPv1, SNMPv2c

**SNMPv1, SNMPv2c Settings**

Read/Write community:

Read only community:

#### Enable SNMPv3

This option contains cryptographic security, a higher security level, which allows you to set the Authentication password and the Encryption password.

- Security name: According to your NMS settings, choose Read/Write or Read Only and enter the community name.
- Authentication type: Select MD5 or SHA as the authentication method.
- Authentication password: Enter the password for authentication (at least 8 characters).
- Encryption password: Enter a password for encryption (at least 8 characters).

Enable SNMPv3

**SNMPv3 Settings**

Read/Write Security name:

Authentication Type:

Authentication Password:

Encryption Password:

Read only Security name:

Authentication Type:

Authentication Password:

Encryption Password:

## Security > User accounts

This section explains how to enable password protection and create multiple accounts.

### Root Password

The administrator account name is “root”, which is permanent and can not be deleted. If you want to add more accounts in the Manage User column, please apply the password for the “root” account first.

1. Type the password identically in both text boxes, then click **Save** to enable password protection.
2. A window will be prompted for authentication; type the correct user’s name and password in their respective fields to access the Network Camera.

### Privilege Management **Advanced Mode**

**PTZ control:** You can modify the management privilege for operators or viewers. Select or deselect the checkboxes, then click **Save** to enable the settings. If you give Viewers the privilege, Operators will also have the ability to control the Network Camera through the main page. (Please refer to Configuration on page 34).

**Allow anonymous viewing:** If you check this item, any client can access the live stream without entering a User ID and Password.

### Account Management

Administrators can create up to 20 user accounts.

1. Input the new user’s name and password.
2. Select the privilege level for the new user account. Click **Add** to enable the setting.

Access rights are sorted by user privilege (Administrator, Operator, and Viewer). Only administrators can access the Configuration page. Although operators cannot access the Configuration page, they can use the URL Commands to get and set the value of parameters. For more information, please refer to URL Commands of the Network Camera on page 122. Viewers can only access the main page for live viewing.

Here you also can change a user’s access rights or delete user accounts.

1. Select an existing account to modify.
2. Make necessary changes and click **Update** or **Delete** to enable the setting.

## Security > HTTPS (Hypertext Transfer Protocol over SSL) Advanced Mode

This section explains how to enable authentication and encrypted communication over SSL (Secure Socket Layer). It helps protect streaming data transmission over the Internet on higher security level.

### Create and Install Certificate Method

Before using HTTPS for communication with the Network Camera, a **Certificate** must be created first. There are three ways to create and install a certificate:

#### Create self-signed certificate

1. Select this option from a pull-down menu.
2. In the first column, select **Enable HTTPS secure connection**, then select a connection option: "HTTP & HTTPS" or "HTTPS only".
3. Click **Create certificate** to generate a certificate.

The screenshot shows the 'HTTPS' configuration page. The 'Enable HTTPS secure connection' checkbox is checked. Under 'Mode', 'HTTP & HTTPS' is selected. Under 'Certificate', the 'method' dropdown is set to 'Create self-signed certificate'. The 'Certificate information' section shows fields for Country (TW), State or province (Asia), Locality (Asia), Organization (VIVOTEK.Inc), Organization unit (VIVOTEK.Inc), Common name (www.vivotek.com), and Validity (3650 days). A blue message box with a progress bar says 'Please wait while the certificate is being generated...'. The 'Create certificate' button is highlighted with a yellow box.

4. The Certificate Information will automatically be displayed as shown below. You can click **Certificate properties** to view detailed information about the certificate.

The screenshot shows the 'Certificate information' panel. The status is 'Active'. The method is 'Create self-signed certificate'. The fields for Country, State or province, Locality, Organization, Organization unit, and Common name are the same as in the previous screenshot. The validity is 3650 days. At the bottom, there is a link for 'Certificate properties' and a 'Remove certificate' button.

5. Click **Save** to preserve your configuration, and your current session with the camera will change to the encrypted connection.
6. If your web session does not automatically change to an encrypted HTTPS session, click **Home** to return to the main page. Change the URL address from "<http://>" to "<https://>" in the address bar and press **Enter** on your keyboard. Some Security Alert dialogs will pop up. Click **OK** or **Yes** to enable HTTPS.

**https://**

The screenshot shows a Microsoft Internet Explorer browser window titled "Network Camera - Microsoft Internet Explorer". The address bar contains "https://92.168.5.151/index.html". The main content area displays the VIVOTEK Mega-Pixel Network Camera interface, which includes a video stream, manual triggers (Digital output, Focus assist), PTZ control (Digital), and a live video feed of a city street. Three security-related dialog boxes are overlaid on the interface:

- Security Alert (top right):** A small dialog box with a blue header and a yellow warning icon. The text reads: "You are about to view pages over a secure connection. Any information you exchange with this site cannot be viewed by anyone else on the Web." It includes a checkbox for "In the future, do not show this warning" and buttons for "OK" and "More Info".
- Security Alert (bottom left):** A larger dialog box with a blue header and a yellow warning icon. The text reads: "Information you exchange with this site cannot be viewed or changed by others. However, there is a problem with the site's security certificate." It lists three issues:
  - The security certificate was issued by a company you have not chosen to trust. View the certificate to determine whether you want to trust the certifying authority.
  - The security certificate date is valid.
  - The name on the security certificate is invalid or does not match the name of the site.
 It asks "Do you want to proceed?" and has buttons for "Yes", "No", and "View Certificate".
- Security Information (bottom right):** A dialog box with a blue header and a yellow warning icon. The text reads: "This page contains both secure and nonsecure items. Do you want to display the nonsecure items?" It has buttons for "Yes", "No", and "More Info".



### Create certificate request and install

1. Select the option from the **Method** pull-down menu.
2. Click **Create certificate** to proceed.
3. The following information will show up in a pop-up window after clicking **Create**. Then click **Save** to generate the certificate request.

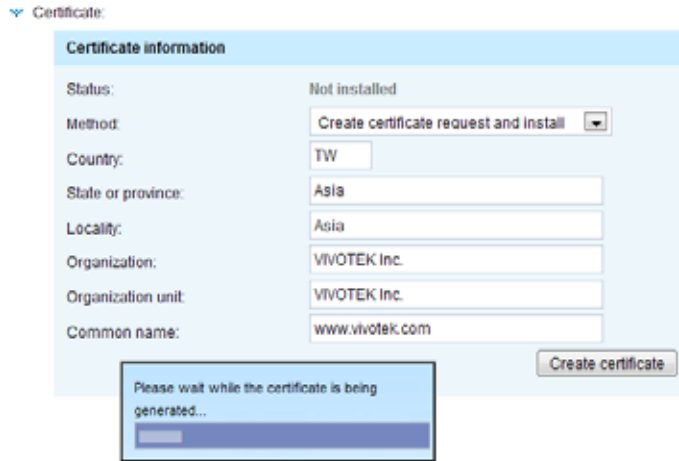

4. The Certificate request window will prompt.

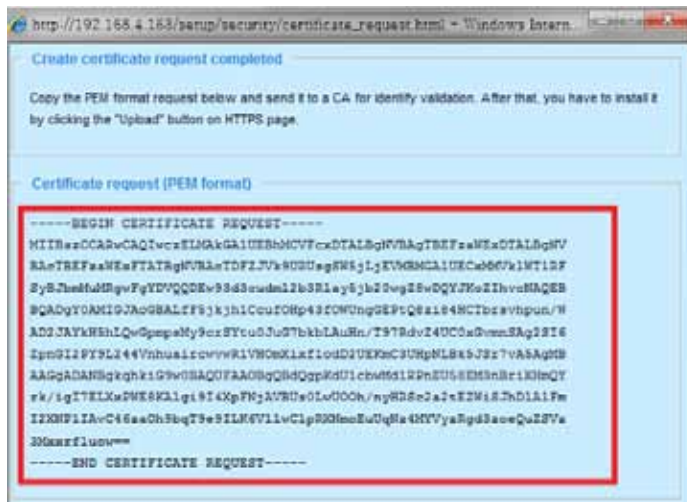

If you see the following Information bar, click **OK** and click on the Information bar at the top of the page to allow pop-ups.

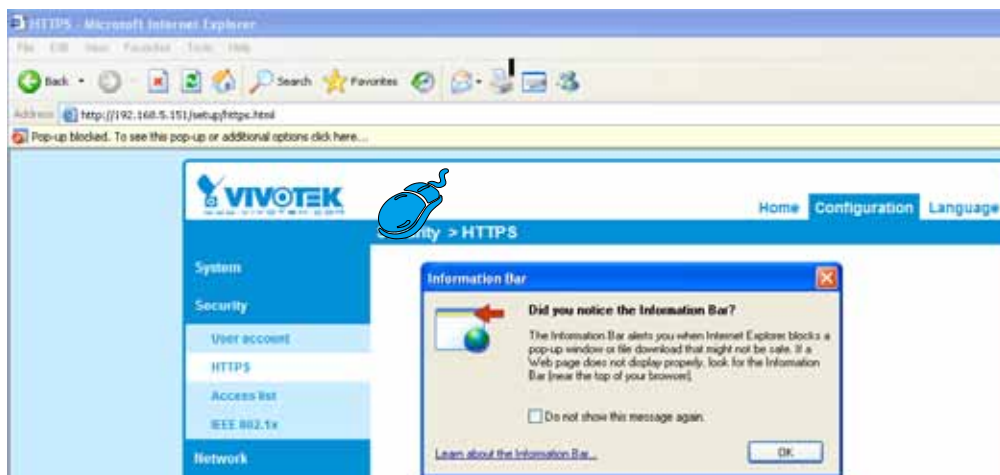

- 5. Look for a trusted certificate authority, such as Symantec's VeriSign Authentication Services, that issues digital certificates. Sign in and purchase the SSL certification service. Copy the certificate request from your request prompt and paste it in the CA's signing request window. Proceed with the rest of the process as CA's instructions on their webpage.

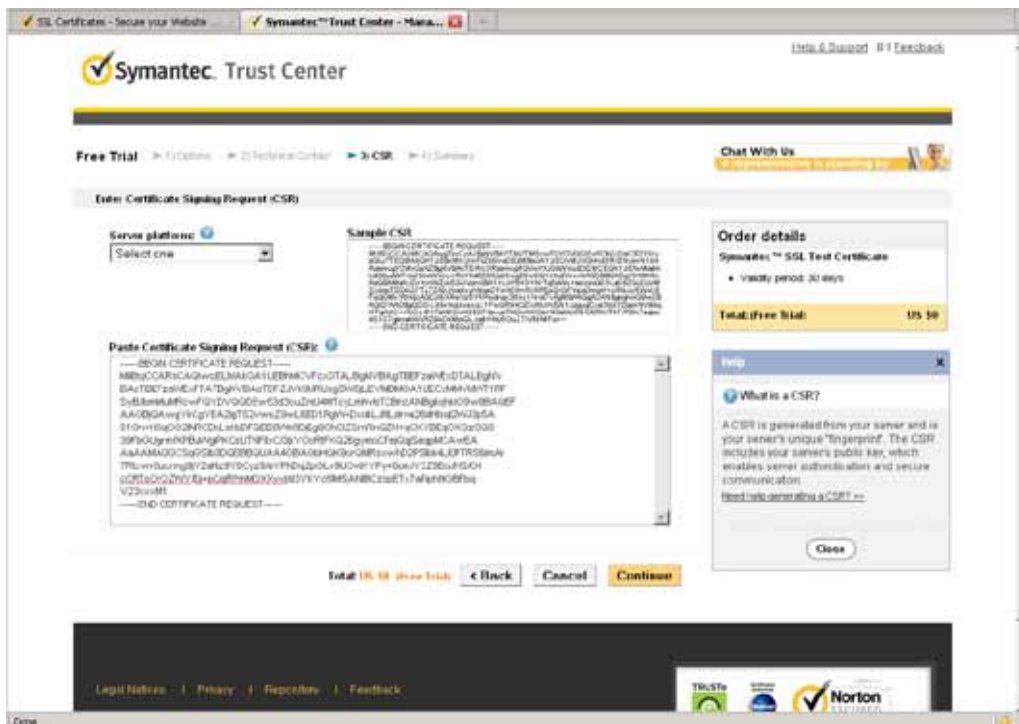

- 6. Once completed, your SSL certificate should be delivered to you via an email or other means. Copy the contents of the certificate in the email and paste it in a text/HTML/hex editor/converter, such as IDM Computer Solutions' UltraEdit.



- Open a new edit, paste the certificate contents, and press ENTER at the end of the contents to add an empty line.

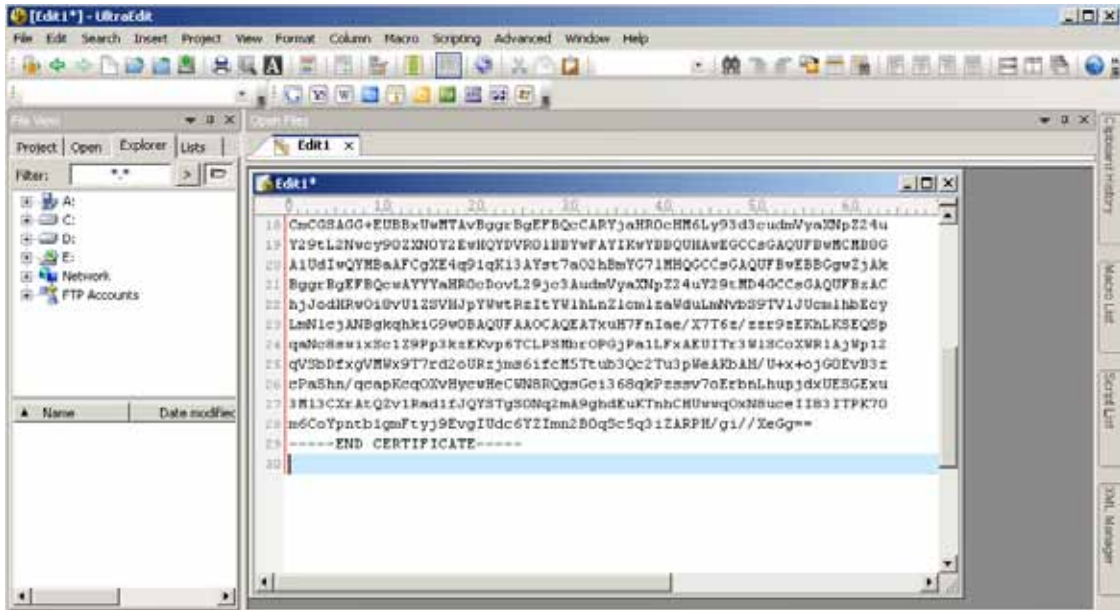

- Convert file format from DOS to UNIX. Open **File** menu > **Conversions** > **DOS to Unix**.

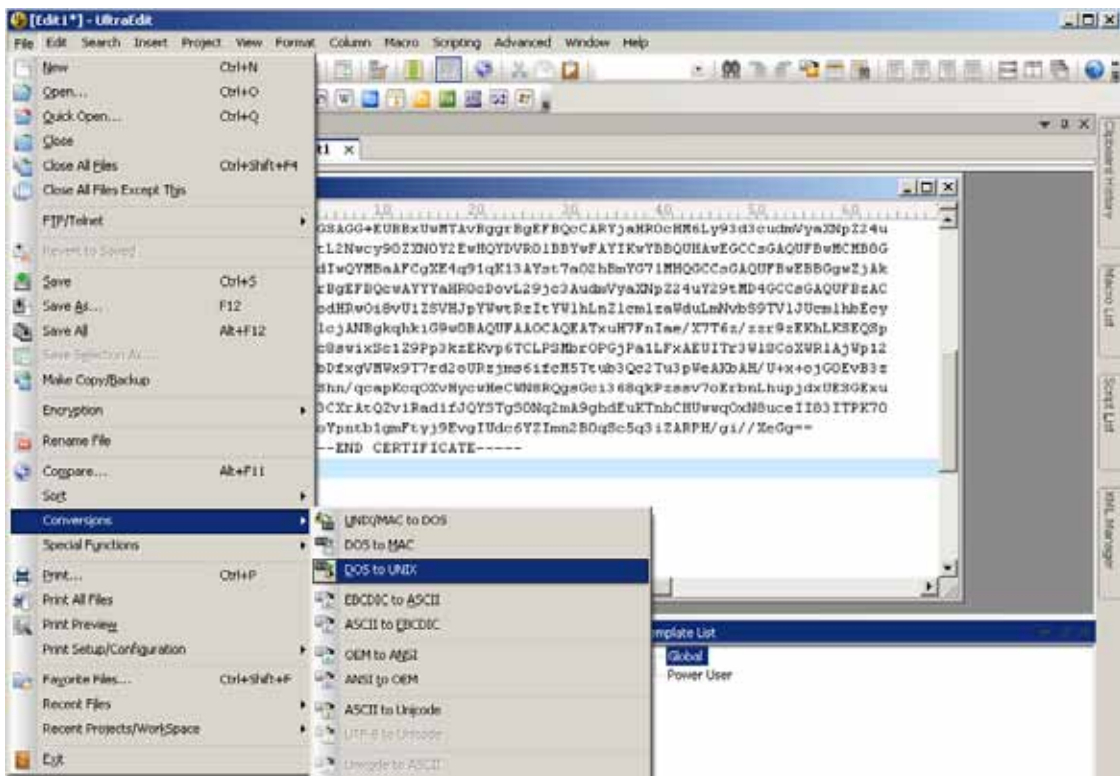

9. Save the edit using the “.crt” extension, using a file name like “CAcert.crt.”

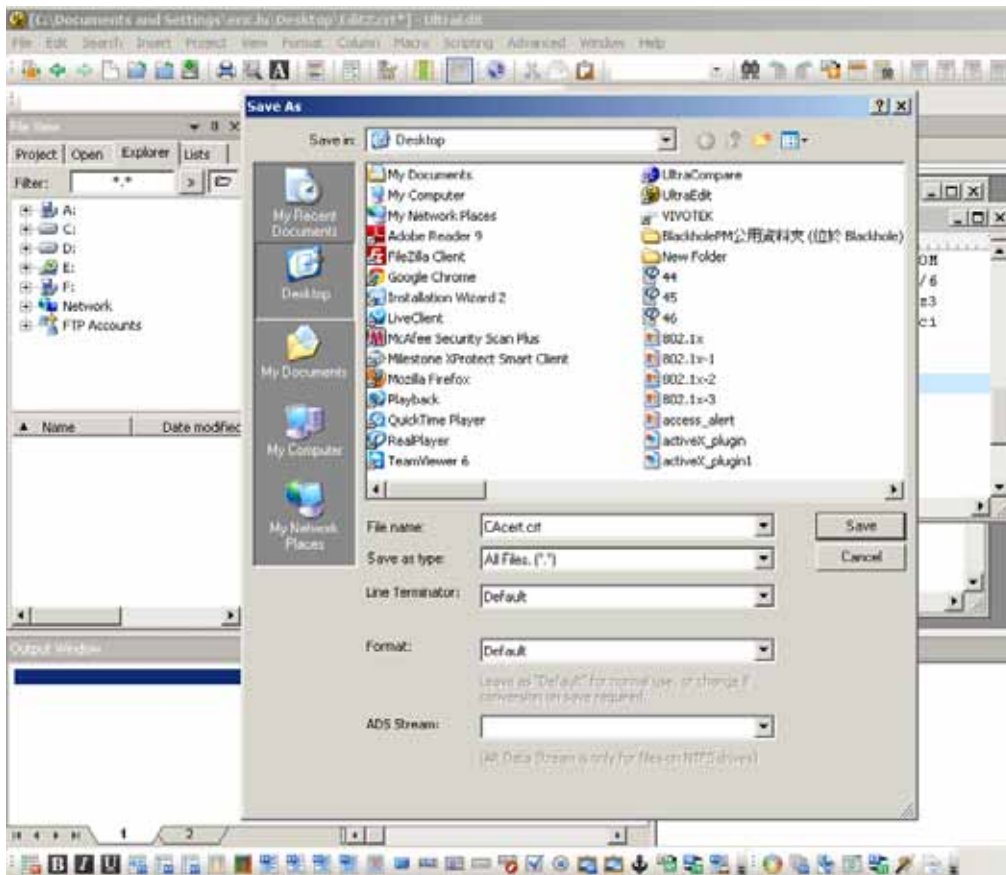

10. Return to the original firmware session, use the **Browse** button to locate the crt certificate file, and click **Upload** to enable the certification.

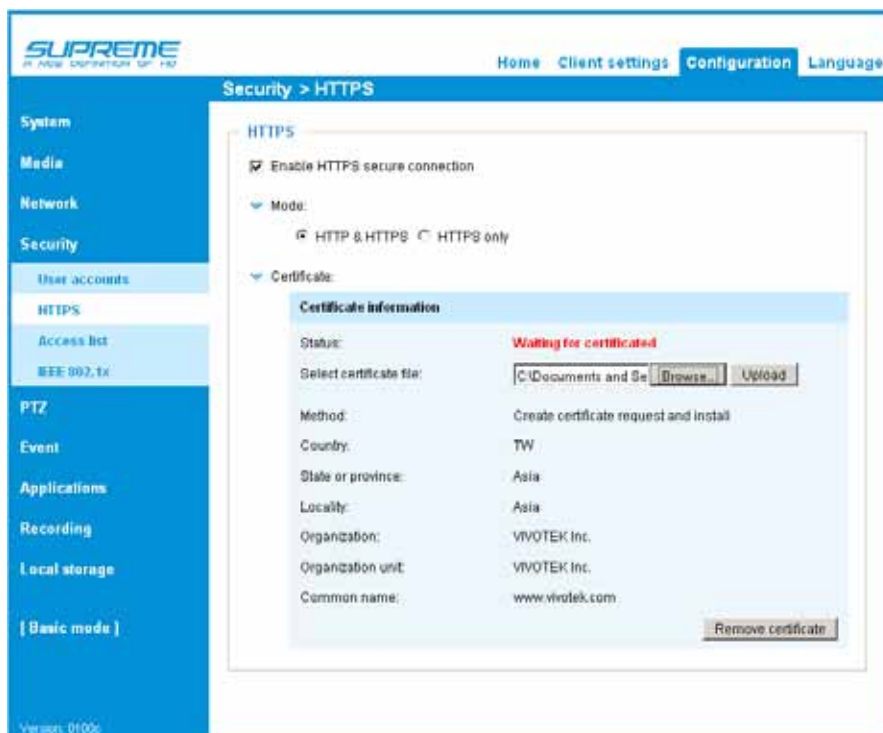

- When the certificate file is successfully loaded, its status will be stated as **Active**. Note that a certificate must have been created and installed before you can click on the **“Save”** button for the configuration to take effect.

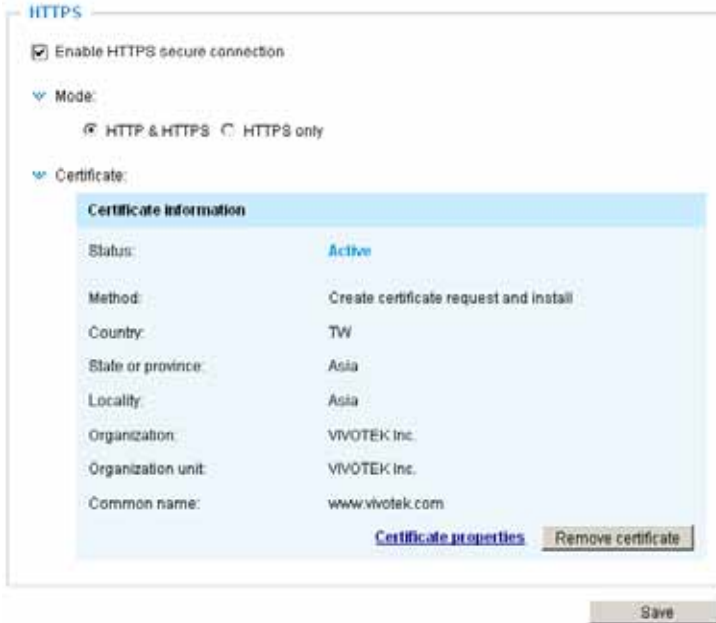

- To begin an encrypted HTTPS session, click **Home** to return to the main page. Change the URL address from **“http://”** to **“https://”** in the address bar and press **Enter** on your keyboard. Some Security Alert dialogs will pop up. Click **OK** or **Yes** to enable HTTPS.

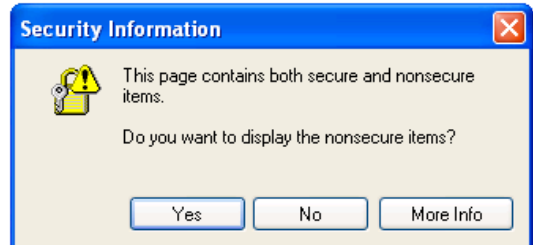
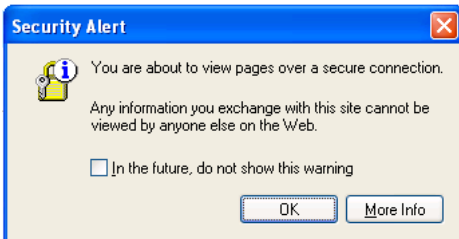



## Security > Access List Advanced Mode

This section explains how to control access permission by verifying the client PCs' IP addresses.

### General Settings

**General settings**

Maximum number of concurrent streaming:  Connection management

Maximum number of concurrent streaming connection(s) limited to: Simultaneous live viewing for 1~10 clients (including stream 1 to stream 4). The default value is 10. If you modify the value and click **Save**, all current connections will be disconnected and automatically attempt to re-link (IE Explorer or Quick Time Player).

View Information: Click this button to display the connection status window showing a list of the current connections. For example:

	IP address	Elapsed time	User ID
<input type="checkbox"/>	172.16.2.53	00:00:05	
<input type="checkbox"/>	192.168.4.104	01:49:35	

Note that only consoles that are currently displaying live streaming will be listed in the View Information list.

- IP address: Current connections to the Network Camera.
- Elapsed time: How much time the client has been at the webpage.
- User ID: If the administrator has set a password for the webpage, the clients have to enter a user name and password to access the live video. The user name will be displayed in the User ID column. If the administrator allows clients to link to the webpage without a user name and password, the User ID column will be empty.

There are some situations that allow clients access to the live video without a user name and password:

1. The administrator does not set up a root password. For more information about how to set up a root password and manage user accounts, please refer to Security > User account on page 77.
2. The administrator has set up a root password, but set **RTSP Authentication** to "disable". For more information about **RTSP Authentication**, please refer to RTSP Streaming on page 68.
3. The administrator has set up a root password, but allows anonymous viewing. For more information about **Allow Anonymous Viewing**, please refer to page 77.

- **Refresh:** Click this button to refresh all current connections.
- **Add to deny list:** You can select entries from the Connection Status list and add them to the Deny List to deny access. Please note that those checked connections will only be disconnected temporarily and will automatically try to re-link again (IE Explore or Quick Time Player). If you want to enable the denied list, please check **Enable access list filtering** and click **Save** in the first column.
- **Disconnect:** If you want to break off the current connections, please select them and click this button. Please note that those checked connections will only be disconnected temporarily and will automatically try to re-link again (IE Explore or Quick Time Player).

## Filter

**Enable access list filtering:** Check this item and click **Save** if you want to enable the access list filtering function.

**Filter type:** Select **Allow** or **Deny** as the filter type. If you choose **Allow Type**, only those clients whose IP addresses are on the Access List below can access the Network Camera, and the others cannot. On the contrary, if you choose **Deny Type**, those clients whose IP addresses are on the Access List below will not be allowed to access the Network Camera, and the others can.

The screenshot shows a web interface titled "Filter". At the top, there is a checkbox labeled "Enable access list filtering" which is checked. Below this, there is a "Filter type" section with two radio buttons: "Allow" and "Deny". The "Deny" radio button is selected. Underneath, there are two sections for access lists. The first is "IPv4 access list", which has an empty text input field and two buttons labeled "Add" and "Delete" below it. The second is "IPv6 access list", which also has an empty text input field and two buttons labeled "Add" and "Delete" below it.

Then you can **Add** a rule to the following Access List. Please note that the IPv6 access list column will not be displayed unless you enable IPv6 on the Network page. For more information about **IPv6 Settings**, please refer to Network > General settings on page 60 for detailed information.



There are three types of rules:

**Single:** This rule allows the user to add an IP address to the Allowed/Denied list.

For example:

**Network:** This rule allows the user to assign a network address and corresponding subnet mask to the Allow/Deny List. The address and network mask are written in CIDR format.

For example:

IP address range 192.168.2.x will be blocked.

If IPv6 filter is preferred, you will be prompted by the following window. Enter the IPv6 address and the two-digit prefix length to specify the range of IP addresses in your configuration.

**Range:** This rule allows the user to assign a range of IP addresses to the Allow/Deny List.

Note: This rule only applies to IPv4 addresses.

For example:

### Administrator IP address

**Always allow the IP address to access this device:** You can check this item and add the Administrator's IP address in this field to make sure the Administrator can always connect to the device.

## Security > IEEE 802.1X Advanced Mode

Enable this function if your network environment uses IEEE 802.1x, which is a port-based network access control. The network devices, intermediary switch/access point/hub, and RADIUS server must support and enable 802.1x settings.

The 802.1x standard is designed to enhance the security of local area networks, which provides authentication to network devices (clients) attached to a network port (wired or wireless). If all certificates between client and server are verified, a point-to-point connection will be enabled; if authentication fails, access on that port will be prohibited. 802.1x utilizes an existing protocol, the Extensible Authentication Protocol (EAP), to facilitate communication.

- The components of a protected network with 802.1x authentication:



1. Supplicant: A client end user (camera), which requests authentication.
2. Authenticator (an access point or a switch): A “go between” which restricts unauthorized end users from communicating with the authentication server.
3. Authentication server (usually a RADIUS server): Checks the client certificate and decides whether to accept the end user’s access request.

- VIVOTEK Network Cameras support two types of EAP methods to perform authentication: **EAP-PEAP** and **EAP-TLS**.

Please follow the steps below to enable 802.1x settings:

1. Before connecting the Network Camera to the protected network with 802.1x, please apply a digital certificate from a Certificate Authority (i.e., your network administrator) which can be validated by a RADIUS server.
2. Connect the Network Camera to a PC or notebook outside of the protected LAN. Open the configuration page of the Network Camera as shown below. Select **EAP-PEAP** or **EAP-TLS** as the EAP method. In the following blanks, enter your ID and password issued by the CA, then upload related certificate(s).

**IEEE 802.1x**

Enable IEEE 802.1x

EAP method: EAP-PEAP

Identity:

Password:

CA certificate:  Browse... Upload

Status: no file Remove

**! IMPORTANT**

The maximum length of password is 200 symbols.

**IEEE 802.1x**

Enable 802.1x

EAP method: EAP-TLS

Identity:

Private key password:

CA certificate:

Status: no file

client certificate:

Status: no file

Client private key:

Status: no file

3. When all settings are complete, move the Network Camera to the protected LAN by connecting it to an 802.1x enabled switch. The devices will then start the authentication automatically.

 **NOTE:**

► *The authentication process for 802.1x:*

1. *The Certificate Authority (CA) provides the required signed certificates to the Network Camera (the supplicant) and the RADIUS Server (the authentication server).*
2. *A Network Camera requests access to the protected LAN using 802.1X via a switch (the authenticator). The client offers its identity and client certificate, which is then forwarded by the switch to the RADIUS Server, which uses an algorithm to authenticate the Network Camera and returns an acceptance or rejection back to the switch.*
3. *The switch also forwards the RADIUS Server's certificate to the Network Camera.*
4. *Assuming all certificates are validated, the switch then changes the Network Camera's state to authorized and is allowed access to the protected network via a pre-configured port.*

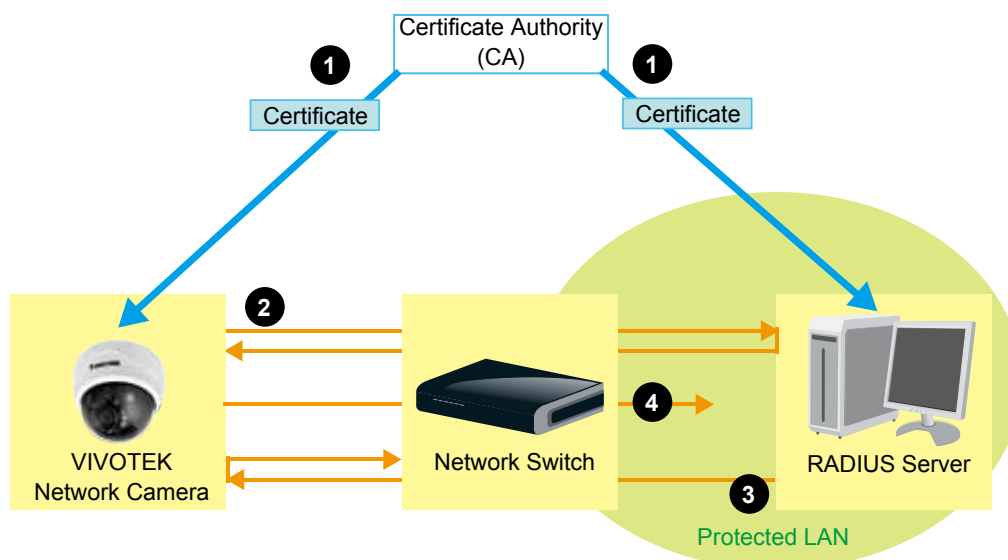

## PTZ > PTZ settings Advanced Mode

This section explains how to control the Network Camera's Pan/Tilt/Zoom operation. There are two ways to enable the camera control function:

**Digital:** Control the e-PTZ operation. Within a field of view, it allows users to quickly move the focus to a target area for close-up viewing without physically moving the camera.

### Digital PTZ Operation (E-PTZ Operation)

The e-PTZ control settings section will be displayed as shown below:

Digital



▲

◀
Home
▶

▼

-
Zoom
+

Pan speed: 0 ▼

Tilt speed: 0 ▼

Zoom speed: 0 ▼

Auto pan/patrol speed: 1 ▼

Go to: -- Select one -- ▼

---

**Preset and patrol settings**

Name: Add preset location

**User preset locations**

lower left

center

right

upper right

lower right

Remove More

>>

**Patrol locations** Dwell time (sec)

<input type="checkbox"/> upper left	5
<input type="checkbox"/> left	5
<input type="checkbox"/> lower left	5
<input type="checkbox"/> center	5
<input type="checkbox"/> right	5

Remove ▲ ▼ More

**Misc settings**

Zoom factor display

Save

Only stream 1 supports the e-PTZ related settings. For details, refer to page 92.

**Auto pan/patrol speed:** Select the speed from 1~5 (slow/fast) to set up the Auto pan/patrol speed control.

#### Zoom factor display

If you check this item, the zoom indicator will be displayed on the home page when you zoom in/out the live viewing window as the picture shown on the next page.

When completed with the e-PTZ settings, click **Save** to enable the settings on this page.

90 - User's Manual

## Home page in the E-PTZ Mode

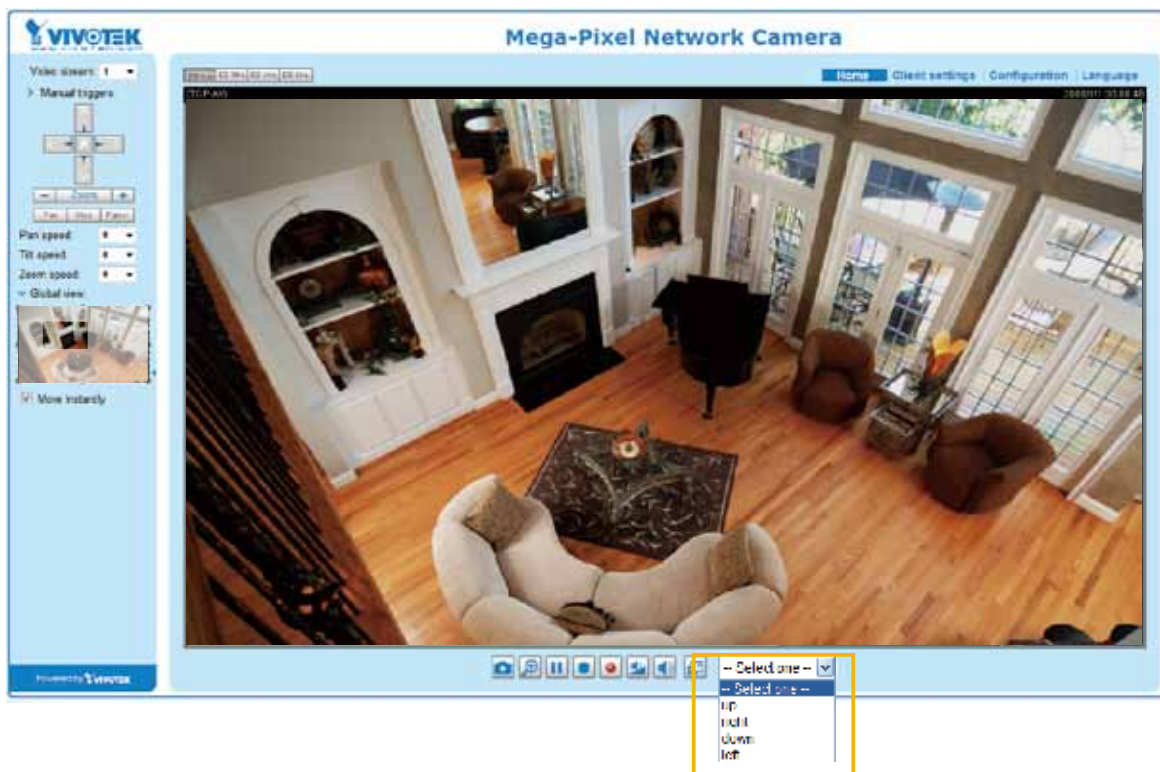

- The e-Preset Positions will also be displayed on the home page. Select one from the drop-down list, and the Network Camera will move to the selected position.
- If you have set up different preset positions for different streams, you can select one of the video streams to display its separate preset positions.

### Global View

In addition to using the e-PTZ control panel, you can also use the mouse to drag or resize the floating frame to pan/tilt/zoom the viewing region. The live view window will also move to the viewing region accordingly.

### Moving Instantly

If you check this item, the live view window will switch to the new viewing region instantly after you move the floating frame. If not selected, the process of moving from one position to another will be shown.

### Click on Image

The e-PTZ function also supports "Click on Image". When you click on any point of the Global View Window or Live View Window, the viewing region will also move to that point.

Note that the "Click on Image" function only applies when you have configured a smaller "Region of Interest" out of the maximum output frame! e.g., an 800 x 600 region from the camera's 1280 x 800 maximum frame size.

**Patrol button:** Click this button, then the Network Camera will patrol among the selected preset positions continuously.

### Patrol settings

You can select some preset positions for the Network Camera to patrol.  
Please follow the steps below to set up a patrol schedule:

1. Select the preset locations on the list, and click **>>**.
2. The selected preset locations will be displayed on the **Patrol locations** list.
3. Set the **Dwell time** for the preset location during an auto patrol.
4. If you want to delete a preset location from the Patrol locations list, select it and click **Remove**.
5. Select a location and click **▲ ▼** to rearrange the patrol order.
6. Select patrol locations you want to save in the list and click **Save** to enable the patrol settings.
7. To implement the patrol schedule, please go to homepage and click on the **Patrol** button. Please refer to the next page.

Digital

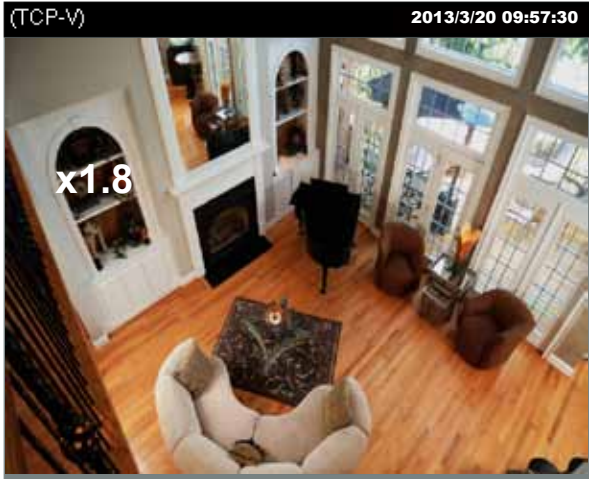

▲

◀
Home
▶

▼

-
Zoom
+

Pan speed:

Tilt speed:

Zoom speed:

Auto pan/patrol speed:

Go to: -- Select one --

---

Preset and patrol settings
2
3

Name:

**User preset locations**

upper left  
 left  
 lower left  
 center  
 right

Remove
More

Select Preset Locations for Patrol

<input type="checkbox"/> Patrol locations	<b>Dwell time (sec)</b>
<input type="checkbox"/> upper left	5
<input type="checkbox"/> left	5
<input type="checkbox"/> lower left	5
<input type="checkbox"/> center	5
<input type="checkbox"/> right	5

Remove
▲ ▼
More

1
>>

---

Misc settings
4
5

Zoom factor display

Save

6

**NOTE:**

- ▶ *The Preset Positions will also be displayed on the Home page. Select one from the **Go to** menu, and the Network Camera will move to the selected preset position.*
  - ▶ *Click Patrol: The Network Camera will patrol along the selected positions repeatedly.*
-



## Event > Event settings Advanced Mode

This section explains how to configure the Network Camera to respond to particular situations (event). A typical application is that when a motion is detected, the Network Camera sends buffered images to an FTP server or e-mail address as notifications. Click on **Help**, there is an illustration shown in the pop-up window explaining that an event can be triggered by many sources, such as motion detection or external digital input devices. When an event is triggered, you can specify what type of action that will be performed. You can configure the Network Camera to send snapshots or videos to your email address or FTP site.

**Event**

Name	Status	Sun	Mon	Tue	Wed	Thu	Fri	Sat	Time	Trigger
<div style="display: flex; align-items: center; gap: 10px;"> <input type="button" value="Add"/> <span style="border: 1px solid blue; padding: 2px;">Help</span> </div>										

close or Esc Key

**Event Trigger**

Ex.  
Motion detection, Periodically,  
Digital input, System boot

**Action (What to do)**

**Media (What to send)**

Ex.  
Snapshot, Video Clip, System  
log, Digital Output

**Server (Where to send)**

Ex.  
Email, FTP, HTTP Server,  
Network storage

### Event

To configure an event with reactive measures such as recording video or snapshots, it is necessary to configure the server and media settings so that the Network Camera will know what action to take (such as which server to send the media files to) when a trigger is activated. An event is an action initiated by a user-defined trigger source. In the **Event** column, click **Add** to open the event settings window. Here you can arrange three elements -- Schedule, Trigger, and Action to set an event. A total of 3 event settings can be configured.

**Event**

Name	Status	Sun	Mon	Tue	Wed	Thu	Fri	Sat	Time	Trigger
<div style="display: flex; align-items: center; gap: 10px;"> <input type="button" value="Add"/> <span style="border: 1px solid blue; padding: 2px;">Help</span> </div>										

Event name:

Enable this event

Priority: Normal

Detect next motion detection or digital input after  second(s).

1. Schedule

2. Trigger

3. Action

**Event Schedule**

Sun  Mon  Tue  Wed  Thu  Fri  Sat

Time:

Always

From  to  [hh:mm]

- **Event name:** Enter a name for the event setting.
- **Enable this event:** Select this option to enable the event setting.
- **Priority:** Select the relative importance of this event (High, Normal, or Low). Events with a higher priority setting will be executed first.
- **Detect next event after  seconds:** Enter the duration in seconds to pause motion detection after a motion is detected. This can prevent event-related actions to take place too frequently.

### 1. Schedule

Specify the period of them during which the event trigger will take effect. Please select the days of the week and the time in a day (in 24-hr time format) for the event triggering schedule. For example, you may prefer an event to be triggered only during the off-office hours.

### 2. Trigger

This is the cause or stimulus which defines when to trigger the Network Camera. The trigger source can be configured to use the Network Camera's built-in motion detection mechanism or external digital input devices.

There are several choices of trigger sources as shown on the next page. Select the item to display the detailed configuration options.

- **Video motion detection**

This option makes use of the built-in motion detection mechanism as a trigger source. To enable this function, you need to configure a Motion Detection Window first. For more information, please refer to Motion Detection on page 107 for details.

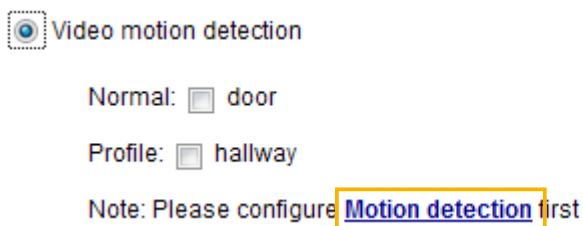

- **Periodically**

This option allows the Network Camera to trigger periodically for every other defined minute. Up to 999 minutes are allowed.

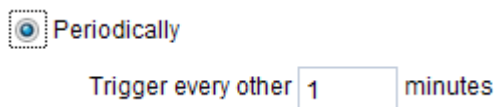

- **Digital input**

This option allows the Network Camera to use an external digital input device or sensor as a trigger source. Depending on your application, there are many choices of digital input devices on the market which helps to detect changes in temperature, vibration, sound, and light, etc.

- **System boot**

This option triggers the Network Camera when the power to the Network Camera is disconnected and re-connected.

- **Recording notify**

This option allows the Network Camera to trigger when the recording disk is full or when recording starts to overwrite older data.

■ Camera tampering detection

This option allows the Network Camera to trigger when the camera detects that it is being tampered with. To enable this function, you need to configure the Tampering Detection option first. Please refer to page 110 for detailed information.



■ Manual Trigger

This option allows users to enable event triggers manually by clicking the on/off button on the homepage. Please configure 1 to 3 associated events before using this function.

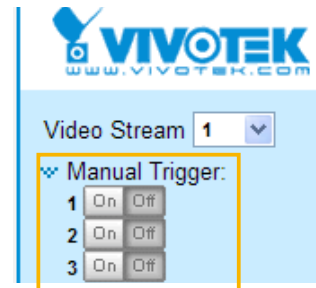
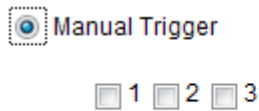

3. Action

Define the actions to be performed by the Network Camera when a trigger is activated.

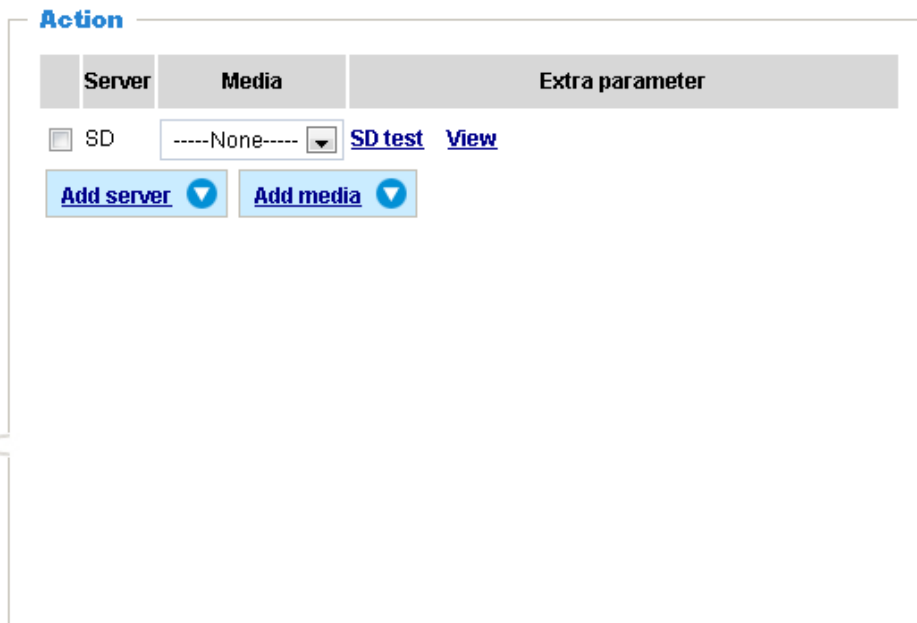

■ Backup media if the network is disconnected (appears if you have a networked storage configured)

Select this option to backup media file on SD card if the network is disconnected. This function will only be displayed after you set up a network storage (NAS). The media to back up can include snapshot images, video, or system logs depending on your event settings.

## Add server

It is necessary to configure the server and media settings so that the Network Camera will know what action to take (such as which server to send the media files to) when a trigger is activated. Click **Add server** to open the server setting window. You can specify where the notification messages are sent to when a trigger is activated. A total of 5 server settings can be configured.

There are four choices of server types available: Email, FTP, HTTP, and Network storage. Select the item to display the detailed configuration options. You can configure either one or all of them.

### Server type - Email

Select to send the media files via email when a trigger is activated.

- Server name: Enter a name for the server setting.
- Sender email address: Enter the email address of the sender.
- Recipient email address: Enter the email address of the recipient.
- Server address: Enter the domain name or IP address of the email server.
- User name: Enter the user name of the email account if necessary.
- Password: Enter the password of the email account if necessary.
- Server port: The default mail server port is set to 25. You can also manually set another port.

If your SMTP server requires a secure connection (SSL), select **This server requires a secure connection (SSL)**.

To verify if the email settings are correctly configured, click **Test**. The result will be shown in a pop-up window. If successful, you will also receive an email indicating the result.



Click **Save server** to enable the settings.

Note that after you configure the first event server, the new event server will automatically display on the Server list. If you wish to add other server options, click **Add server**.



### Server type - FTP

Select to send the media files to an FTP server when a trigger is activated.

Server name:

**Server Type**

Email

FTP

Server address:

Server port:

User name:

Password:

FTP folder name:

Passive mode

HTTP

Network storage

- Server name: Enter a name for the server setting.
- Server address: Enter the domain name or IP address of the FTP server.
- Server port: By default, the FTP server port is set to 21. It can also be assigned to another port number between 1025 and 65535.
- User name: Enter the login name of the FTP account.
- Password: Enter the password of the FTP account.
- FTP folder name  
Enter the folder where the media files will be placed. If the folder name does not exist, the Network Camera will automatically create one on the FTP server.

#### ■ Passive mode

Most firewalls do not accept new connections initiated from external requests. If the FTP server supports passive mode, select this option to enable passive mode FTP and allow data transmission to pass through the firewall. The firmware default has the Passive mode checkbox selected.

To verify if the FTP settings are correctly configured, click **Test**. The result will be shown in a pop-up window as shown below. If successful, you will also receive a test.txt file on the FTP server.

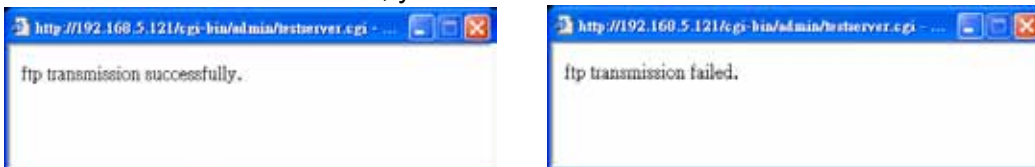

Click **Save server** to enable the settings.

#### Server type - HTTP

Select to send the media files to an HTTP server when a trigger is activated.

- Server name: Enter a name for the server setting.
- URL: Enter the URL of the HTTP server.
- User name: Enter the user name if necessary.
- Password: Enter the password if necessary.

To verify if the HTTP settings are correctly configured, click **Test**. The result will be shown in a pop-up window as shown below. If successful, you will receive a test.txt file on the HTTP server.



Click **Save server** to enable the settings.

**Network storage:**

Select to send the media files to a networked storage when a trigger is activated. Please refer to **NAS server** on page 116 for details. Note that only one NAS server can be configured.

Click **Save server** to enable the settings.

**Action**

Backup media if the network is disconnected

Server	Media	Extra parameter
<input type="checkbox"/> Email	-----None-----	
<input type="checkbox"/> FTP	-----None-----	
<input type="checkbox"/> HTTP	-----None-----	
<input type="checkbox"/> NAS	-----None-----	<input type="checkbox"/> Create folders by date time and hour automatically

[View](#)

- **SD Test:** Click to test your SD card. The system will display a message indicating the result as a success or a failure. If you want to use your SD card for local storage, please format it before use. Please refer to page 102 for detailed information.
- **View:** Click this button to open a file list window. This function is only for SD card and Network Storage. If you click the View button for an SD card, a Local storage page will prompt so that you can manage the recorded files on SD card. For more information about Local storage, please refer to page 118. If you click the View button for a Network storage, a file directory window will prompt for you to view recorded data on Network storage. For detailed illustration, please refer to the next page.
- **Create folders by date, time, and hour automatically:** If you select this item, the system will automatically create folders by the date when video footages are stored onto the networked storage.

The following is an example of a file destination with video clips:

<input type="checkbox"/>		<a href="#">20130120</a>	<p style="color: green;">The format is: YYYYMMDD</p> <p style="color: blue;">Click to open the directory</p>
<input type="checkbox"/>		<a href="#">20130121</a>	
<input type="checkbox"/>		<a href="#">20130122</a>	
<input type="button" value="Delete"/> <input type="button" value="Delete all"/>			<p style="color: blue;">Click to delete all recorded data</p>

Click to delete selected items



Click [20130120](#) to open the directory:

**The format is: HH (24r)**

Click to open the file list for that hour

< 07 08 09 10 11 12 13 14 15 16 17 >

	file name	size	date	time
<input type="checkbox"/>	<a href="#">Recording1 58.mp4</a>	2526004	2013/01/20	07:58:28
<input type="checkbox"/>	<a href="#">Recording1 59.mp4</a>	2563536	2013/01/20	07:59:28

Click to delete selected items

Click to go back to the previous level of the directory

Click to delete all recorded data

< 07 08 09 10 11 12 13 14 15 16 17 >

	file name	size	date	time
<input type="checkbox"/>	<a href="#">Recording1 58.mp4</a>	2526004	2013/01/20	07:58:28
<input type="checkbox"/>	<a href="#">Recording1 59.mp4</a>	2563536	2013/01/20	07:59:28

**The format is: File name prefix + Minute (mm)**

You can set up the file name prefix on Add media page. Please refer to next page for detailed information.

### Add media

Click **Add media** to open the media setting window. You can specify the type of media that will be sent when a trigger is activated. A total of 5 media settings can be configured. There are three choices of media types available: Snapshot, Video Clip, and System log. Select the item to display the detailed configuration options. You can configure either one or all of them.

#### Media type - Snapshot

Select to send snapshots when a trigger is activated.

- Media name: Enter a name for the media setting.
- Source: Select to take snapshots from any of the video streams.
- Send  pre-event images  
The Network Camera has a buffer to temporarily hold data for a short period of time. Enter a number to decide how many images to capture before a trigger is activated. Up to 7 images can be generated.
- Send  post-event images  
Enter a number to decide how many images to capture after a trigger is activated. Up to 7 images can be generated.

For example, if both the Send pre-event images and Send post-event images are set to 7, a total of 15 images can be generated after a trigger is activated.

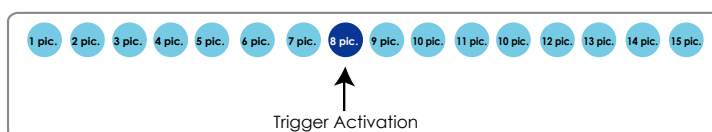

- File name prefix  
Enter the text that will be appended to the front of the file name.

- Add date and time suffix to the file name  
Select this option to add a date/time suffix to the file name.  
For example:

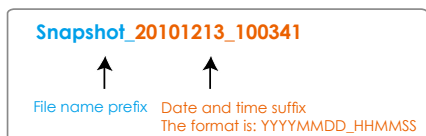

Click **Save media** to enable the settings.

Note that after you set up the first media server, a new column for media server will automatically display on the Media list. If you wish to add more media options, click **Add media**.

Media type - Video clip

Select to send video clips when a trigger is activated.

- Media name: Enter a name for the media setting.
- Source: Select a video stream as the source of video clip.
- Pre-event recording  
The Network Camera has a buffer to temporarily hold data up to a certain limit. Enter a number to decide the duration of recording before a trigger is activated. Up to 9 seconds can be set.
- Maximum duration  
Specify the maximum recording duration in seconds. The duration can be up to 10 seconds. For example, if pre-event recording is set to five seconds and the maximum duration is set to ten seconds, the Network Camera continues to record for another 4 seconds after a trigger is activated.

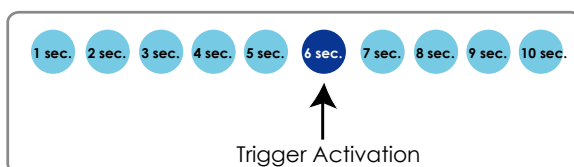

- Maximum file size**  
 Specify the maximum file size allowed. Some users may need to stitch the video clips together when searching and packing up forensic evidence.
- File name prefix**  
 Enter the text that will be appended to the front of the file name.  
 For example:



Click **Save media** to enable the settings.

Media type - System log

Select to send a system log when a trigger is activated.

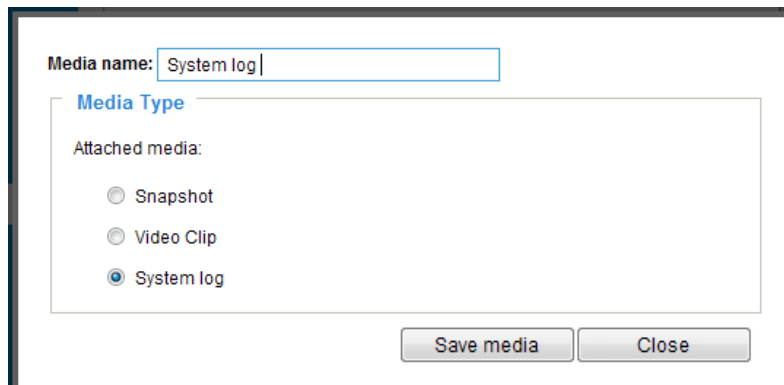

Click **Save media** to enable the settings, then click **Close** to exit the page.

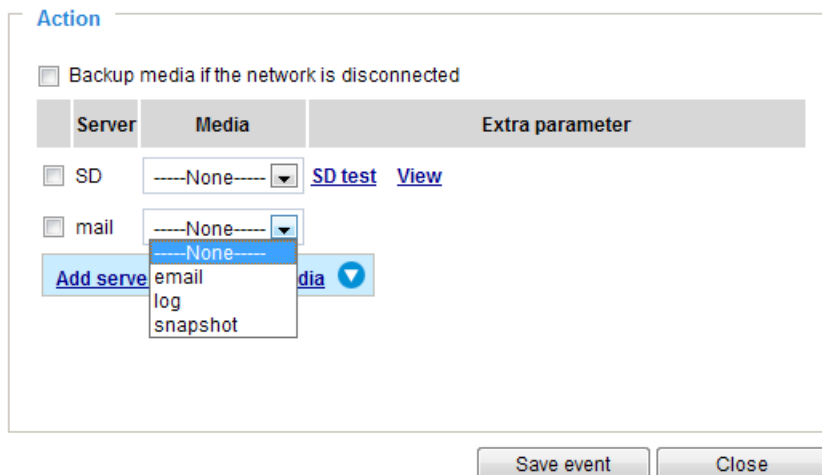

In the Event settings column, the Servers and Medias you configured will be listed; please make sure the Event -> Status is indicated as **ON**, in order to enable the event triggering action.

When completed, click the **Save event** button to enable the settings and click **Close** to exit Event Settings page. The new Event / Server settings / Media will appear in the event drop-down list on the Event setting page.

Please see the example of the Event setting page below:

**Event**

Name	Status	Sun	Mon	Tue	Wed	Thu	Fri	Sat	Time	Trigger	
<a href="#">event1</a>	<b>ON</b>	V	V	V	V	V	V	V	00:00~24:00	seq	<input type="button" value="Delete"/>

[Help](#)

**Server settings**

Name	Type	Address/Location	
<a href="#">HTTP</a>	http	http://192.168.5.10	<input type="button" value="Delete"/>

**Media**

Available memory space: 13000KB

Name	Type	
<a href="#">Snapshot</a>	snapshot	<input type="button" value="Delete"/>
<a href="#">Video clip</a>	videoclip	<input type="button" value="Delete"/>
<a href="#">System log</a>	systemlog	<input type="button" value="Delete"/>

**Customized script**

Name	Date	Time
------	------	------

When the Event Status is **ON**, the event configuration above is triggered by motion detection, the Network Camera will automatically send snapshots via e-mail.

If you want to stop the event trigger, you can click on the **ON** button to turn it to **OFF** status or click the **Delete** button to remove the event setting.

To remove a server setting from the list, select a server name from the drop-down list and click **Delete**. Note that you can only delete a server setting when it is not applied in an existing setting.

To remove a media setting from the list, select a media name from the drop-down list and click **Delete**. Note that you can only delete a media setting when it is not applied in an existing setting.

## Customized Script

This function allows you to upload a sample script (.xml file) to the webpage, which will save your time on configuring the settings. Please note that there is a limited number of customized scripts you can upload; if the current amount of customized scripts has reached the limit, an alert message will prompt. If you need more information, please contact VIVOTEK technical support.

### Customized Script

Name	Date	Time
<a href="#">User1</a>	20130213	18:13:46
<a href="#">User2</a>	20130213	18:11:32

Click to upload a file
Add
User1 ▾
Delete

```

<?xml version="1.0" encoding="UTF-8"?>
<eventmgr version="0102">
  <mgprocess></mgprocess>
  <!-- from 08:30:00-20:30:00 on Monday to Friday every week -->
  <schedule id="0">
    <duration>
      <weekdays>1-5</weekdays>
      <time>08:30:00-20:30:00</time>
    </duration>
  </schedule>
  <!-- Motion -->
  <action condition="0">
    <status id="0"><trigger/></status>
    <status id="1"><trigger/></status>
  </action>
  <event id="0">
    <description>Mail system log to email address</description>
    <condition></condition>
    <scheduleid></scheduleid>
    <delay>0</delay>
    <!-- users can send email with title "Notice" to recipient pudding.yang@vivotek.com. The body of mail is the log messages -->
    <process>
      /usr/bin/empollent -s "Notice" -f IP"193@vivotek.com -b /var/log/messages -S ma.vivotek.tw -
      M S pudding.yang@vivotek.com
    </process>
    <priority>0</priority>
  </event>
</eventmgr>
                
```

Upload

Click to modify the script online

## Applications > Motion detection

This section explains how to configure the Network Camera to enable motion detection. A total of three motion detection windows can be configured.



Enable motion detection

(TCP-V) 2013/2/3 14:39:12

Window name:  
hallway

Sensitivity: 67%

Percentage: 18%

New Save

Profile

Motion Detection Setting 1:  
For normal situations

Motion Detection Setting 2:  
For special situations

Follow the steps below to enable motion detection:

1. Click **New** to add a new motion detection window.
2. In the Window Name text box, enter a name for the motion detection window.
  - To move and resize the window, drag it to a preferred location, and let cursor stay on the edge of the window until it changes into the resize cursor.
  - To delete a window, click X on the upper right corner of the window.
3. Define the sensitivity to moving objects and the space ratio of all alerted pixels by moving the Sensitivity and Percentage slider bar.
4. Click **Save** to enable the settings.
5. Select **Enable motion detection** to enable this function.

For example:



Enable motion detection

(TCP-V) 2013/2/3 14:39:12

Window name:  
hallway

Sensitivity: 67%

Percentage: 18%

New Save

Profile

The Percentage Indicator will rise or fall depending on the variation between sequential images. When motions are detected by the Network Camera and are considered to exceed the preset threshold, the red bar rises. Meanwhile, the motion detection window will be outlined in red for 2 or 3 seconds. Photos or videos can be captured instantly and configured to be sent to a remote server (via an Email or FTP server). For more information on how to configure an event setting, please refer to Event settings on page 94.



A green bar indicates that even though motions have been detected, the event has not been triggered because the image variations still fall under the preset threshold.

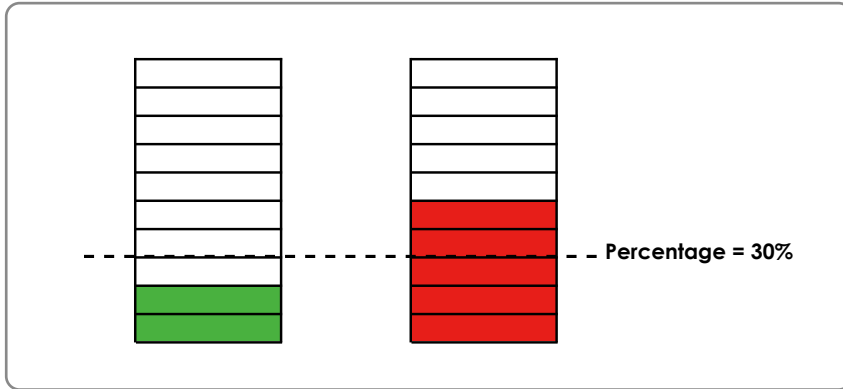

If you want to configure other motion detection settings for day/night/schedule mode (e.g., for a different lighting condition), please click on **Profile** to open the Motion Detection Profile Settings page as shown below. Another three motion detection windows can be configured on this page.

>Motion detection profile settings

(TCP-V) 2000/1/1 02:26:12

06B 06C

hallway ✕

Window name:

Sensitivity: 0%

Percentage: 0%

**General settings**

Enable this profile

This profile is applied to:

Schedule mode:

From  to  [hh:mm]

Please follow the steps below to set up a profile:

1. Create a new motion detection window.
2. Check **Enable this profile**.
3. Select the applicable period of time for the Schedule mode. Please manually enter a range of time.
4. Click **Save** to enable the settings and click **Close** to exit the page.

This motion detection window will also be displayed on the Event Settings page. You can go to **Event > Event settings > Trigger** to select it as a trigger source. Please refer to page 114 for detailed information.

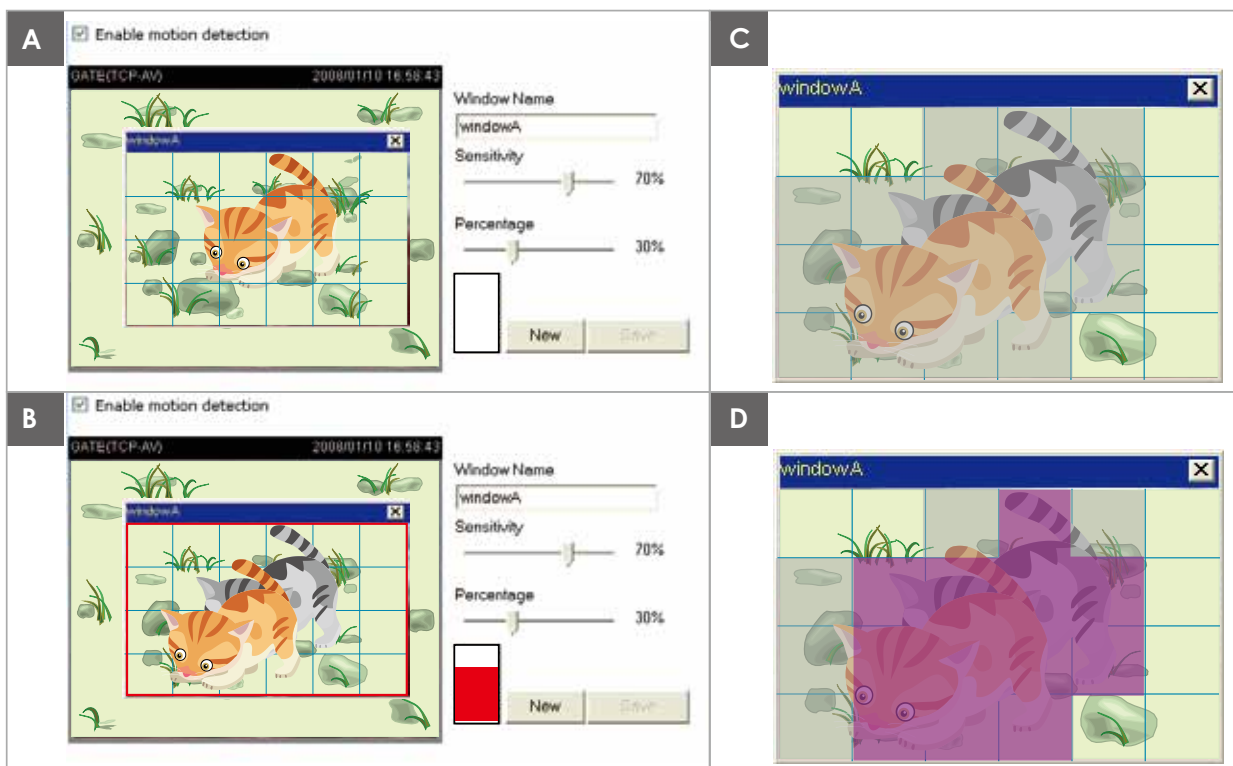
**NOTE:**► *How does motion detection work?*

There are two motion detection parameters: *Sensitivity* and *Percentage*. In the illustration above, frame A and frame B are two sequential images. Pixel differences between the two frames are detected and highlighted in gray (frame C) and will be compared with the sensitivity setting. *Sensitivity* is a value that expresses the sensitivity to moving objects. Higher sensitivity settings are expected to detect slight movements while smaller sensitivity settings will neglect them. When the sensitivity is set to 70%, the Network Camera defines the pixels in the purple areas as “alerted pixels” (frame D).

*Percentage* is a value that expresses the proportion of “alerted pixels” to all pixels in the motion detection window. In this case, 50% of pixels are identified as “alerted pixels”. When the percentage is set to 30%, the motions are judged to exceed the defined threshold; therefore, the motion window will be outlined in red.

For applications that require a high level of security management, it is suggested to use higher sensitivity settings and smaller percentage values.

## Applications > Digital input Advanced Mode

**Digital input**

Normal status:       High  Low

Current status:      **High**

Connect Digital input devices to the camera's terminal block, the camera will automatically detect the current connection state as pulled-high or pulled-low. You may then define the Normal status of the digital input.

**Digital input:** Select High or Low as the state of the signal to define the "Normal status" for the digital input. Connect the digital input lines to the Network Camera, and the camera will detect and report the current status.

## Applications > Tampering detection

This section explains how to set up camera tamper detection. With tamper detection, the camera is capable of detecting incidents such as **redirection, blocking or defocusing**, or even **spray paint**.

**Camera tampering detection**

Enable camera tampering detection

Trigger duration  seconds [10~600]

Please follow the steps below to set up the camera tamper detection function:

1. Check **Enable camera tampering detection**.
2. Enter the tamper trigger duration. (10 sec. ~ 10 min.) The tamper alarm will be triggered only when the tampering factor (the difference between current frame and pre-saved background) exceeds the trigger threshold.
3. Set up the event source as Camera Tampering Detection on **Event > Event settings > Trigger**. Please refer to page 114 for detailed information.

## Applications > VADP (VIVOTEK Application Development Platform (FD8137H Series))

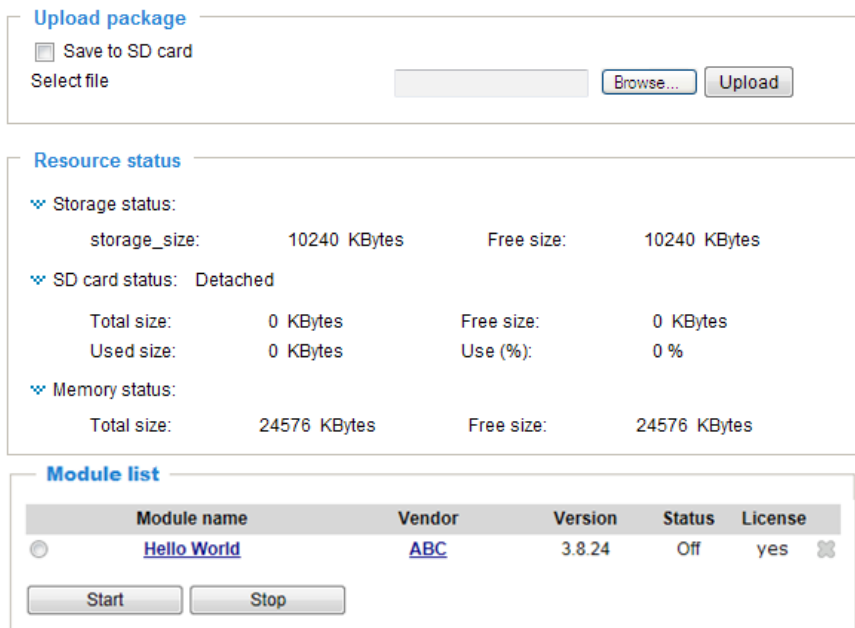

Users can store and execute VIVOTEK's or 3rd-party software modules onto the camera's flash memory or SD card. These software modules can apply in video analysis for intelligent video applications such as license plate recognition, object counting, or as an agent for edge recording, etc.

- Once the software package is successfully uploaded, the module configuration (vadv.xml) information is displayed. When uploading a module, the camera will examine whether the module fits the predefined VADP requirements. Please contact technical support or the vendor of your 3rd-party module for the parameters contained within.
- Users can also run VIVOTEK's VADP packages as a means to access updated functionality instead of replacing the entire firmware.
- Note that for some cameras the flash is too small to hold VADP packages. These cameras will have its "Save to SD card" checkbox selected and grayed-out for all time.
- The file system of SD card (FAT32) does not support soft (symbolic) link. It will return failure if your module tries to create soft links on SD card.

To utilize a software module, acquire the software package and click **Browse** and **Upload** buttons. The screen message for a successful upload is shown below:

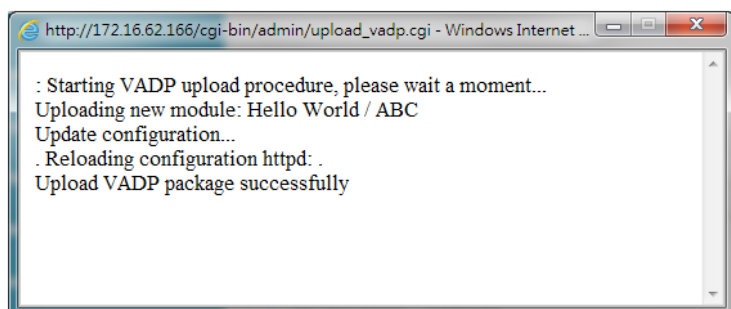

To start a module, select the checkcircle in front, and click the **Start** button.

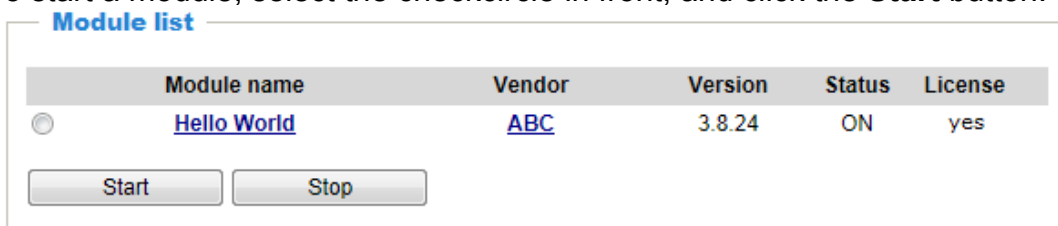

If you should need to remove a module, select the checkcircle in front and then click the **Stop** button. By then the module status will become **OFF**, and the **X** button will appear at the end of the row. Click on the **X** button to remove an existing module.

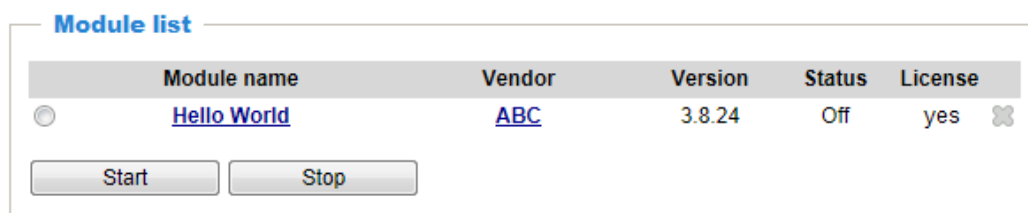

When prompted by a confirm message, Click **Yes** to proceed.

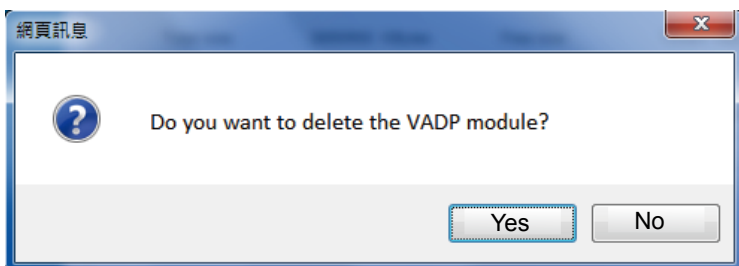

Note that the actual memory consumed while operating the module will be indicated on the **Memory status** field. This helps determine whether a running module has consumed too much of system resources.

## Recording > Recording settings Advanced Mode

This section explains how to configure the recording settings for the Network Camera.

### Recording Settings

Insert your SD card and click [here](#) to test

**Recording settings**

Name	Status	Sun	Mon	Tue	Wed	Thu	Fri	Sat	Time	Source	Destination	Delete
Add												

Note: Before setup recording, you may setup network storage via [NAS server](#) page



#### NOTE:

- ▶ Please remember to format your SD card via the camera's web console (in the Local storage . SD card management page) when using it for the first time. Please refer to page 118 for detailed information.

### Recording Settings

Click **Add** to open the recording setting window. On this page, you can define the adaptive recording, recording source, recording schedule, and recording capacity. A total of 2 recording settings can be configured.

Recording name:

Enable this recording

With adaptive recording

Pre-event recording:  seconds [0~9]

Post-event recording:  seconds [0~10]

Priority:

Source:

**Trigger**

Schedule

Sun  Mon  Tue  Wed  Thu  Fri  Sat

**Time**

Always

From  to  [hh:mm]

Network fail

Note: To enable recording notification please configure [Event](#) first

Close Save

- Recording name: Enter a name for the recording setting.
- Enable this recording: Select this option to enable video recording.
- With adaptive recording: Select this option will activate the frame rate control according to alarm trigger. The frame control means that when there is a triggered alarm, the frame rate will raise up to the value you've configured on the Video quality page. Please refer to page 57 for more information.

If you enable adaptive recording on a camera, only when an event is triggered on Camera A will the server record the full frame rate streaming data; otherwise, it will only request the I frame data during normal monitoring, thus effectively saves bandwidths and storage space.

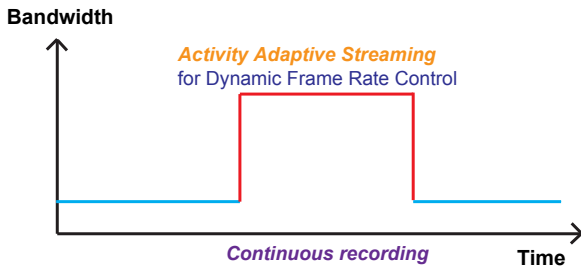
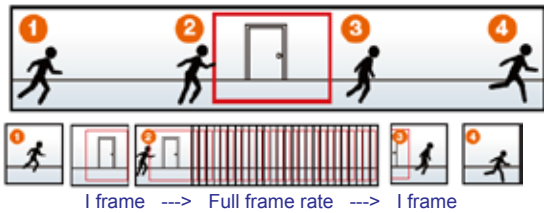

**NOTE:**

- ▶ To enable adaptive recording, please make sure you've set up the trigger source such as Motion Detection, DI Device, or Manual Trigger.
- ▶ When there is no alarm trigger:
  - JPEG mode: record 1 frame per second.
  - H.264 mode: record the I frame only.
- ▶ When the I frame period is >1s on Video settings page, firmware will force decrease the I frame period to 1s when adaptive recording is enabled.

The alarm trigger includes: motion detection and DI detection. Please refer to Event Settings on page 94.

- Pre-event recording and post-event recording  
The Network Camera has a buffer that temporarily holds data for a period of time. Therefore, when an event occurs, the camera can retrieve image frames taken several seconds ago. Enter a number to define the duration of recording before and after a trigger is activated.
- Priority: Select the relative importance of this recording (High, Normal, or Low). Recording with a higher priority setting will be processed first.
- Source: Select a video stream as the recording source.

**NOTE:**

- ▶ To enable recording notification please configure **Event settings** first . Please refer to page 94.

Please follow the steps below to set up the recording.

**1. Trigger**

Select a trigger source.

**Trigger**

Schedule

Sun  Mon  Tue  Wed  Thu  Fri  Sat

**Time**

Always

From  to  [hh:mm]

Network fail

- Schedule: The server will start to record files on the local storage or network storage (NAS).
- Network fail: Since network fail, the server will start to record files on the local storage (SD card).



## 2. Destination

You can select the SD card or network storage (NAS) for the recorded video files. If you have not configured a NAS server, see details in the following.

Priority:  Source:

**Destination**

Destination:

Capacity:

Entire free space

Reserved space:  Mbytes

Enable cyclic recording

**Recording file management**

Maximum duration:  minutes [1~30]

Maximum file size:  MB [50~3072]

File name prefix:

Note: To enable recording notification please configure [Event](#) first

## NAS server

Click **Add NAS server** to open the server setting window and follow the steps below to set up:

1. Fill in the information for your server.

For example:

1. Trigger

↓

2. Destination

Destination:

**Add NAS server**

Server name:  3

Server type

Network storage

Network storage location:  Network storage path  
(\\server name or IP address\folder name)

(For example: \\my\_nas\disk\folder)

Workgroup:

User name:  User name and password for your server

Password:

2  4

2. Click **Test** to check the setting. The result will be shown in the pop-up window.

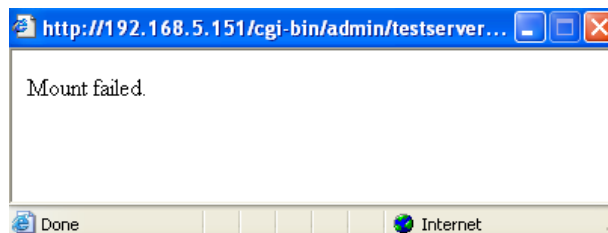
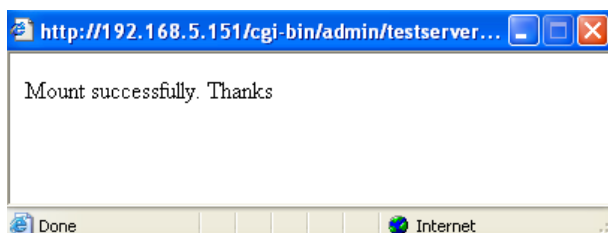

If successful, you will receive a test.txt file on the network storage server.

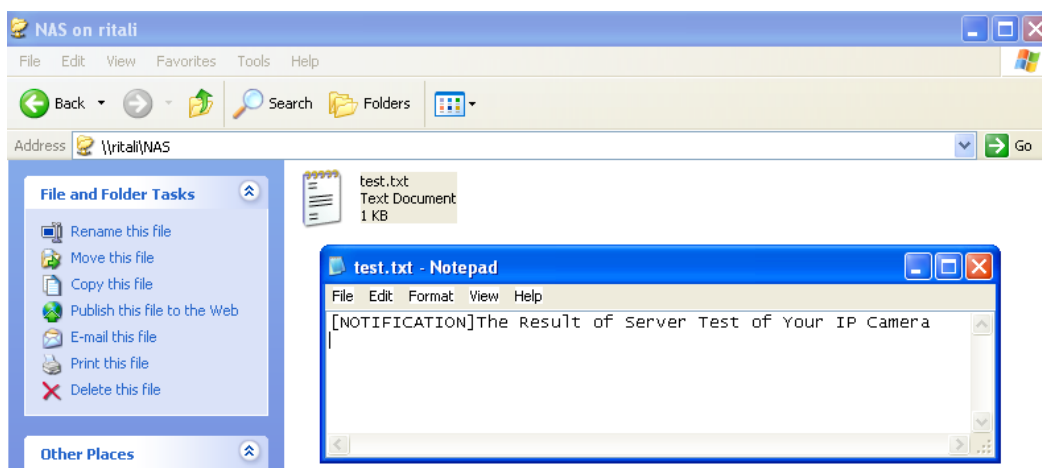

3. Enter a server name.
4. Click **Save** to complete the settings and click **Close** to exit the page.

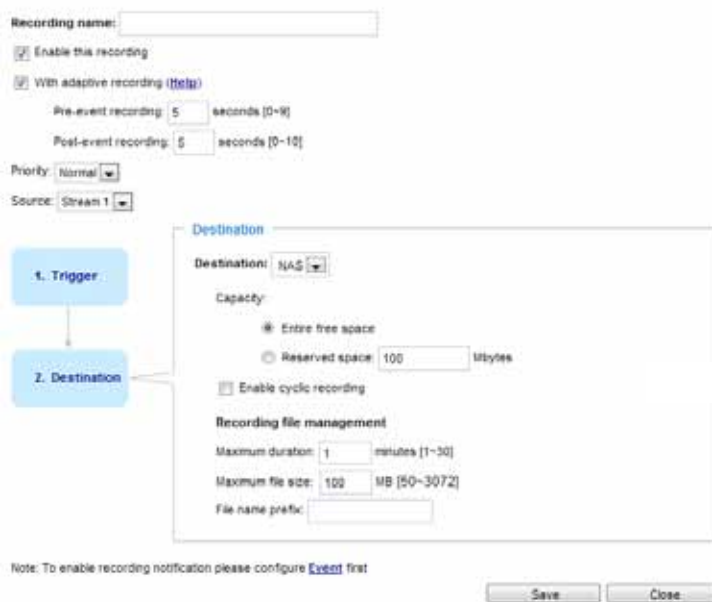

- **Capacity:** You can choose either the entire free space available or limit the reserved space. The recording size limit must be larger than the reserved amount for cyclic recording.
- **Enable cyclic recording:** If you check this item, when the maximum capacity is reached, the oldest file will be overwritten by the latest one. The reserved amount is reserved for the transaction stage when the storage space is about to be full and new data arrives. The minimum for the Reserved space must be larger than 15 MegaBytes.
- **Recording file management:** You can manually assign the Maximum duration and the Maximum file size for each recording footage. You may need to stitch individual files together under some circumstances. You may also designate a file name prefix by filling in the responsive text field.
- **File name prefix:** Enter the text that will be appended to the front of the file name.

If you want to enable recording notification, please click [Event](#) to configure event triggering settings. Please refer to **Event > Event settings** on page 94 for more details.

When completed, select **Enable this recording**. Click **Save** to enable the setting and click **Close** to exit this page. When the system begins recording, it will send the recorded files to the network storage. The new recording name will appear in the drop-down list on the recording page as shown below.

To remove a recording setting from the list, select a recording name from the drop-down list and click **Delete**.

Recording settings												
Name	Status	Sun	Mon	Tue	Wed	Thu	Fri	Sat	Time	Source	Destination	Delete
<a href="#">recording</a>	<a href="#">ON</a>	V	V	V	V	V	V	V	00:00~24:00	stream1	<a href="#">NAS</a>	<input type="button" value="Delete"/>
<input type="button" value="Add"/>		<a href="#">SD test</a>										

- Click [recording \(Name\)](#): Opens the Recording Settings page to modify.
- Click [ON \(Status\)](#): The Status will become [OFF](#) and stop recording.
- Click [NAS \(Destination\)](#): Opens the file list of recordings as shown below. For more information about folder naming rules, please refer to page 100 for details.

<input type="checkbox"/>	<input type="checkbox"/>	<a href="#">20130210</a>
<input type="checkbox"/>	<input type="checkbox"/>	<a href="#">20130211</a>
<input type="checkbox"/>	<input type="checkbox"/>	<a href="#">20130212</a>
<input type="button" value="Delete"/>		<input type="button" value="Delete all"/>

## Local storage > SD card management Advanced Mode

This section explains how to manage the local storage on the Network Camera. Here you can view SD card status, and implement SD card control.

### SD card status

This column shows the status and reserved space of your SD card. Please remember to format the SD card when using for the first time.

**SD card status**

SD card status: Detached ————— **no SD card**

Total size: 0 KBytes Free size: 0 KBytes

Used size: 0 KBytes Use (%): 0 %

**SD card status**

SD card status: Ready

Total size:	7810152 KBytes	Free size:	7602048 KBytes
Used size:	208104 KBytes	Use (%):	2.665 %

### SD card control

**SD card control**

Enable cyclic storage

Enable automatic disk cleanup

Maximum duration for keeping files:  days

- **Enable cyclic storage:** Check this item if you want to enable cyclic recording. When the maximum capacity is reached, the oldest file will be overwritten by the latest one.
- **Enable automatic disk cleanup:** Check this item and enter the number of days you wish to retain a file. For example, if you enter “7 days”, the recorded files will be stored on the SD card for 7 days.

Click **Save** to enable your settings.

## Local storage > Content management Advanced Mode

This section explains how to manage the content of recorded videos on the Network Camera. Here you can search and view the records and view the searched results.

### Searching and Viewing the Records

This column allows the user to set up search criteria for recorded data. If you do not select any criteria and click **Search** button, all recorded data will be listed in the **Search Results** column.

Searching and viewing the records

File attributes

Trigger type:

<input type="checkbox"/>	System boot	<input type="checkbox"/>	Recording notify	<input type="checkbox"/>	Motion
<input type="checkbox"/>	Digital input	<input type="checkbox"/>	Network fail	<input type="checkbox"/>	Periodically
<input type="checkbox"/>	Manual triggers	<input type="checkbox"/>	Tampering detection		

Media type:

<input type="checkbox"/>	Video clip	<input type="checkbox"/>	Snapshot	<input type="checkbox"/>	Text
--------------------------	------------	--------------------------	----------	--------------------------	------

Locked:

<input type="checkbox"/>	Locked	<input type="checkbox"/>	Unlocked		
--------------------------	--------	--------------------------	----------	--	--

Backup:

<input type="checkbox"/>	Backup				
--------------------------	--------	--	--	--	--

Trigger time

From:

Date	<input type="text"/>	Time	<input type="text"/>
------	----------------------	------	----------------------

to:

Date	<input type="text"/>	Time	<input type="text"/>
------	----------------------	------	----------------------

(yyyy-mm-dd) (hh:mm:ss)

- File attributes: Select one or more items as your search criteria.
- Trigger time: Manually enter the time range you want to search for contents created at a specific point in time.

Click **Search** and the recorded data corresponding to the search criteria will be listed in **Search Results** window.

## Search Results

The following is an example of search results. There are four columns: Trigger time, Media type, Trigger type, and Locked. Click  to sort the search results in either direction.





Numbers of entries displayed on one page

Enter a key word to filter the search results

Search results

Show 10 entries

Search:

	Trigger time 	Media Type 	Trigger type 	Locked 	Backup 
<input checked="" type="checkbox"/>	2010-08-26 10:42:55	Video Clip	Periodically	No	No
<input type="checkbox"/>	2010-08-26 10:43:56	Video Clip	Periodically	No	No
<input type="checkbox"/>	2010-08-26 10:44:56	Video Clip	Periodically	No	No
<input type="checkbox"/>	2010-08-26 10:45:57	Video Clip	Periodically	No	No
<input type="checkbox"/>	2010-08-26 10:46:58	Video Clip	Periodically	No	No
<input type="checkbox"/>	2010-08-26 10:47:59	Video Clip	Periodically	No	No

Highlight an item

- **View:** Click on a search result which will highlight the selected item in purple as shown above. Click the **View** button and a media window will pop up to play back the selected file. For example:

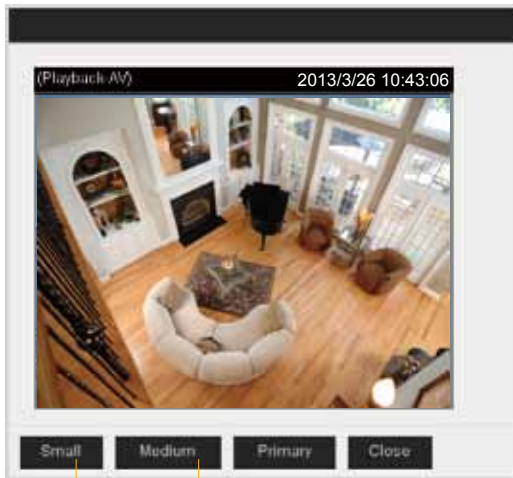

Click to adjust the image size

- **Download:** Click on a search result to highlight the selected item in purple as shown above. Then click the **Download** button and a file download window will pop up for you to save the file.
- **JPEGs to AVI:** This functions only applies to “JPEG“ format files such as snapshots. You can select several snapshots from the list, then click this button. Those snapshots will be converted into an AVI file.

- Lock/Unlock:** Select the desired search results, then click this button. The selected items will become Locked, which will not be deleted during cyclic recording. You can click again to unlock the selections. For example:

Search results

Show 10 entries

Search:

<input type="checkbox"/>	Trigger time	Media type	Trigger type	Locked	Backup
<input checked="" type="checkbox"/>	2012-07-11 17:56:12	Video clip	Boot	Yes	No
<input checked="" type="checkbox"/>	2012-07-11 17:35:10	Snapshot	Boot	Yes	No
<input checked="" type="checkbox"/>	2012-07-11 17:35:10	Snapshot	Boot	Yes	No
<input type="checkbox"/>	2012-07-11 17:35:10	Snapshot	Boot	No	No
<input type="checkbox"/>	2012-07-11 17:35:10	Snapshot	Boot	No	No
<input type="checkbox"/>	2012-07-11 17:35:10	Snapshot	Boot	No	No

Showing 1 to 6 of 6 entries

View Download JPEGs to AVI Lock/Unlock Remove

Note: "View" and "Download" only apply to the highlight item

Click to switch pages

- Remove:** Select the desired search results, then click this button to delete the files.



# Appendix

## URL Commands for the Network Camera

### 1. Overview

For some customers who already have their own web site or web control application, the Network Camera/Video Server can be easily integrated through URL syntax. This section specifies the external HTTP-based application programming interface. The HTTP-based camera interface provides the functionality to request a single image, control camera functions (PTZ, output relay etc.), and get and set internal parameter values. The image and CGI-requests are handled by the built-in Web server.

### 2. Style Convention

In URL syntax and in descriptions of CGI parameters, text within angle brackets denotes content that is to be replaced with either a value or a string. When replacing the text string, the angle brackets should also be replaced. An example of this is the description of the name for the server, denoted with `<servername>` in the URL syntax description below, that is replaced with the string `myserver` in the URL syntax example further down in the page.

URL syntax is denoted with the word "Syntax:" written in bold face followed by a box with the referenced syntax as shown below. For example, name of the server is written as `<servername>` and is intended to be replaced with the name of the actual server. This can either be a name, e.g., "mywebcam" or "thecam.adomain.net" or the associated IP number for the server, e.g., 192.168.0.220.

Syntax:

```
http://<servername>/cgi-bin/viewer/video.jpg
```

Description of returned data is written with "Return:" in bold face followed by the returned data in a box. All data is returned in HTTP format, i.e., each line is separated with a Carriage Return and Line Feed (CRLF) printed as `\r\n`.

Return:

```
HTTP/1.0 <HTTP code> <HTTP text>\r\n
```

URL syntax examples are written with "Example:" in bold face followed by a short description and a light grey box with the example.

**Example:** request a single snapshot image

```
http://mywebserver/cgi-bin/viewer/video.jpg
```

### 3. General CGI URL Syntax and Parameters

When the CGI request includes internal camera parameters, these parameters must be written exactly as they are named in the camera or video server. The CGIs are organized in functionally-related directories under the cgi-bin directory. The file extension .cgi is required.

Syntax:

```
http://<servername>/cgi-bin/<subdir>[/<subdir>...]/<cgi>.<ext>  
[?<parameter>=<value>[&<parameter>=<value>...]]
```

**Example:** Set digital output #1 to active

<http://mywebserver/cgi-bin/dido/setdo.cgi?do1=1>

VIVOTEK Confidential

## 4. Security Level

SECURITY LEVEL	SUB-DIRECTORY	DESCRIPTION
0	anonymous	Unprotected.
1 [view]	anonymous, viewer, dido, camctrl	1. Can view, listen, talk to camera. 2. Can control DI/DO, PTZ of the camera.
4 [operator]	anonymous, viewer, dido, camctrl, operator	Operator access rights can modify most of the camera's parameters except some privileges and network options.
6 [admin]	anonymous, viewer, dido, camctrl, operator, admin	Administrator access rights can fully control the camera's operations.
7	N/A	Internal parameters. Unable to be changed by any external interfaces.

## 5. Get Server Parameter Values

**Note:** The access right depends on the URL directory.

**Method:** GET/POST

Syntax:

```
http://<servername>/cgi-bin/anonymous/getparam.cgi?[<parameter>]
[&<parameter>...]

http://<servername>/cgi-bin/viewer/getparam.cgi?[<parameter>]
[&<parameter>...]

http://<servername>/cgi-bin/operator/getparam.cgi?[<parameter>]
[&<parameter>...]

http://<servername>/cgi-bin/admin/getparam.cgi?[<parameter>]
[&<parameter>...]
```

Where the *<parameter>* should be *<group>[\_<name>]*. If you do not specify any parameters, all the parameters on the server will be returned. If you specify only *<group>*, the parameters of the related group will be returned.

When querying parameter values, the current parameter values are returned.

A successful control request returns parameter pairs as follows:

Return:

```
HTTP/1.0 200 OK\r\n
Content-Type: text/html\r\n
Context-Length: <length>\r\n
\r\n
<parameter pair>
```

where *<parameter pair>* is

```
<parameter>=<value>\r\n
```

```
[<parameter pair>]
```

*<length>* is the actual length of content.

**Example:** Request IP address and its response

Request:

```
http://192.168.0.123/cgi-bin/admin/getparam.cgi?network_ipaddress
```

Response:

HTTP/1.0 200 OK\r\n

Content-Type: text/html\r\n

Content-Length: 33\r\n

\r\n

network\_ipaddress=192.168.0.123\r\n

VIVOTEK Confidential

## 6. Set Server Parameter Values

**Note:** The access right depends on the URL directory.

**Method:** GET/POST

Syntax:

```
http://<servername>/cgi-bin/anonymous/setparam.cgi? <parameter>=<value>
[&<parameter>=<value>...][&return=<return page>]
```

```
http://<servername>/cgi-bin/viewer/setparam.cgi? <parameter>=<value>
[&<parameter>=<value>...][&return=<return page>]
```

```
http://<servername>/cgi-bin/operator/setparam.cgi? <parameter>=<value>
[&<parameter>=<value>...][&return=<return page>]
```

```
http://<servername>/cgi-bin/admin/setparam.cgi? <parameter>=<value>
[&<parameter>=<value>...][&return=<return page>]
```

PARAMETER	VALUE	DESCRIPTION
<b>&lt;group&gt;_&lt;name&gt;</b>	value to assigned	Assign <i>&lt;value&gt;</i> to the parameter <i>&lt;group&gt;_&lt;name&gt;</i> .
<b>return</b>	<i>&lt;return page&gt;</i>	Redirect to the page <i>&lt;return page&gt;</i> after the parameter is assigned. The <i>&lt;return page&gt;</i> can be a full URL path or relative path according to the current path. If you omit this parameter, it will redirect to an empty page.  (Note: The return page can be a general HTML file (.htm, .html). It cannot be a CGI command or have any extra parameters. This parameter must be placed at the end of the parameter list

Return:

```
HTTP/1.0 200 OK\r\n
Content-Type: text/html\r\n
Context-Length: <length>\r\n
\r\n
<parameter pair>
```

where *<parameter pair>* is

```
<parameter>=<value>\r\n
[<parameter pair>]
```

Only the parameters that you set and are readable will be returned.

**Example:** Set the IP address of server to 192.168.0.123:

Request:

[http://myserver/cgi-bin/admin/setparam.cgi?network\\_ipaddress=192.168.0.123](http://myserver/cgi-bin/admin/setparam.cgi?network_ipaddress=192.168.0.123)

Response:

HTTP/1.0 200 OK\r\n

Content-Type: text/html\r\n

Content-Length: 33\r\n

\r\n

network\_ipaddress=192.168.0.123\r\n

VIVOTEK Confidential



## 7. Available parameters on the server

This chapter defines all the parameters which can be configured or retrieved from VIVOTEK network camera or video server. The general format of description is listed in the table below

Valid values:

VALID VALUES	DESCRIPTION
string[<n>]	Text strings shorter than 'n' characters. The characters “,’, <, >, & are invalid.
string[n~m]	Text strings longer than 'n' characters and shorter than 'm' characters. The characters “,’, <, >, & are invalid.
password[<n>]	The same as string but displays “*” instead.
integer	Any number between $(-2^{31} - 1)$ and $(2^{31} - 1)$ .
positive integer	Any number between 0 and $(2^{32} - 1)$ .
<m> ~ <n>	Any number between 'm' and 'n'.
domain name[<n>]	A string limited to a domain name shorter than 'n' characters (eg. www.ibm.com).
email address [<n>]	A string limited to an email address shorter than 'n' characters (eg. joe@www.ibm.com).
ip address	A string limited to an IP address (eg. 192.168.1.1).
mac address	A string limited to contain a MAC address without hyphens or colons.
boolean	A boolean value of 1 or 0 represents [Yes or No], [True or False], [Enable or Disable].
<value1>, <value2>, <value3>, ...	Enumeration. Only given values are valid.
blank	A blank string.
everything inside <>	A description
integer primary key	SQLite data type. A 32-bit signed integer. The value is assigned a unique integer by the server.
text	SQLite data type. The value is a text string, stored using the database encoding (UTF-8, UTF-16BE or UTF-16-LE).
coordinate	x, y coordinate (eg. 0,0)
window size	window width and height (eg. 800x600)

NOTE: The camera should not be restarted when parameters are changed.

## 7.1 system

### Group: system

NAME	VALUE	DEFAULT	SECURITY (get/set)	DESCRIPTION
hostname	string[64]	Mega-Pixel Network Camera	1/6	Host name of server.
ledoff	<boolean>	0	6/6	Turn on (0) or turn off (1) all led indicators.
date	<YYYY/MM/DD>, keep, auto	<current date>	6/6	Current date of system. Set to 'keep' to keep date unchanged. Set to 'auto' to use NTP to synchronize date.
time	<hh:mm:ss>, keep, auto	<current time>	6/6	Current time of the system. Set to 'keep' to keep time unchanged. Set to 'auto' to use NTP to synchronize time.
datetime	<MMDDhhmm YYYY.ss>	<current time>	6/6	Another current time format of the system.
ntp	<domain name>, <ip address>, <blank>	<blank>	6/6	NTP server.
timezoneindex	-489 ~ 529	320	6/6	Indicate timezone and area. -480: GMT-12:00 Eniwetok, Kwajalein -440: GMT-11:00 Midway Island, Samoa -400: GMT-10:00 Hawaii -360: GMT-09:00 Alaska -320: GMT-08:00 Las Vegas, San_Francisco, Vancouver -280: GMT-07:00 Mountain Time, Denver -281: GMT-07:00 Arizona -240: GMT-06:00 Central

				<p>America, Central Time,  Mexico City, Saskatchewan  -200: GMT-05:00 Eastern  Time, New York, Toronto  -201: GMT-05:00 Bogota,  Lima, Quito, Indiana  -180: GMT-04:30 Caracas  -160: GMT-04:00 Atlantic  Time, Canada, La Paz,  Santiago  -140: GMT-03:30  Newfoundland  -120: GMT-03:00 Brasilia,  Buenos Aires,  Georgetown, Greenland  -80: GMT-02:00 Mid-Atlantic  -40: GMT-01:00 Azores,  Cape_Verde_IS.  0: GMT Casablanca,  Greenwich Mean Time:  Dublin,  Edinburgh, Lisbon, London  40: GMT 01:00 Amsterdam,  Berlin, Rome, Stockholm,  Vienna, Madrid, Paris  41: GMT 01:00 Warsaw,  Budapest, Bern  80: GMT 02:00 Athens,  Helsinki, Istanbul, Riga  81: GMT 02:00 Cairo  82: GMT 02:00 Lebanon,  Minsk  83: GMT 02:00 Israel  120: GMT 03:00 Baghdad,  Kuwait, Riyadh, Moscow, St.  Petersburg, Nairobi  121: GMT 03:00 Iraq  140: GMT 03:30 Tehran  160: GMT 04:00 Abu Dhabi,</p>
--	--	--	--	---

				<p>Muscat, Baku, Tbilisi, Yerevan 180: GMT 04:30 Kabul 200: GMT 05:00 Ekaterinburg, Islamabad, Karachi, Tashkent 220: GMT 05:30 Calcutta, Chennai, Mumbai, New Delhi 230: GMT 05:45 Kathmandu 240: GMT 06:00 Almaty, Novosibirsk, Astana, Dhaka, Sri Jayawardenepura 260: GMT 06:30 Rangoon 280: GMT 07:00 Bangkok, Hanoi, Jakarta, Krasnoyarsk 320: GMT 08:00 Beijing, Chongging, Hong Kong, Kuala Lumpur, Singapore, Taipei 360: GMT 09:00 Osaka, Sapporo, Tokyo, Seoul, Yakutsk 380: GMT 09:30 Adelaide, Darwin 400: GMT 10:00 Brisbane, Canberra, Melbourne, Sydney, Guam, Vladivostok 440: GMT 11:00 Magadan, Solomon Is., New Caledonia 480: GMT 12:00 Aucklan, Wellington, Fiji, Kamchatka, Marshall Is. 520: GMT 13:00 Nuku'Alofa</p>
daylight_enable	<boolean>	0	6/6	Enable automatic daylight saving time in time zone.
daylight_auto_begintime	string[19]	NONE	6/7	Display the current daylight saving start time.
daylight_auto_endtime	string[19]	NONE	6/7	Display the current daylight saving end time.

daylight_timezones	string	0	6/6	List time zone index which support daylight saving time.
updateinterval	0, 3600, 86400, 604800, 2592000	0	6/6	0 to Disable automatic time adjustment, otherwise, it indicates the seconds between NTP automatic update intervals.
restore	0, <positive integer>	N/A	7/6	Restore the system parameters to default values after <value> seconds.
reset	0, <positive integer>	N/A	7/6	Restart the server after <value> seconds if <value> is non-negative.
restoreexceptnet	0, <positive integer>	N/A	7/6	Restore the system parameters to default values except (ipaddress, subnet, router, dns1, dns2, pppoe). This command can cooperate with other “restoreexceptXYZ” commands. When cooperating with others, the system parameters will be restored to the default value except for a union of the combined results.
restoreexceptdst	0, <positive integer>	N/A	7/6	Restore the system parameters to default values except all daylight saving time settings. This command can cooperate with other “restoreexceptXYZ” commands. When cooperating with others, the system parameters will be restored to default values except for a union of

				combined results.
restoreexceptlang	0, <positive integer>	N/A	7/6	Restore the system parameters to default values except the custom language file the user has uploaded. This command can cooperate with other “restoreexceptXYZ” commands. When cooperating with others, the system parameters will be restored to the default value except for a union of the combined results.
restoreexceptvdp	0, <positive integer>	N/A	99/6	Restore the system parameters to default values except the vdp parameters and VADP modules that stored in the system. This command can cooperate with other “restoreexceptXYZ” commands. When cooperating with others, the system parameters will be restored to the default value except for a union of the combined results.

### 7.1.1 system.info

Subgroup of **system: info** (The fields in this group are unchangeable.)

NAME	VALUE	DEFAULT	SECURITY (get/set)	DESCRIPTION
modelname	string[40]	FD8137H	0/7	Internal model name of the server
serialnumber	<mac address>	<product mac address>	0/7	12 characters MAC address (without hyphens).
firmwareversion	string[40]	<product	0/7	Firmware version, including

		dependent>		model, company, and version number in the format: <MODEL-BRAND-VERSION>
language_count	<integer>	9	0/7	Number of webpage languages available on the server.
language_i<0~(count-1)>	string[16]	English Deutsch Español Français Italiano 日本語 Português 简体中文 繁體中文	0/7	Available language lists.
customlanguage_maxcount	<integer>	1	0/6	Maximum number of custom languages supported on the server.
customlanguage_count	<integer>	0	0/6	Number of custom languages which have been uploaded to the server.
customlanguage_i<0~(max count-1)>	string	N/A	0/6	Custom language name.

## 7.2 status

Group: **status**

NAME	VALUE	DEFAULT	SECURITY (get/set)	DESCRIPTION
di_i<0~(ndi-1)>	<boolean>	0	1/7	0 => Inactive, normal 1 => Active, triggered
daynight	day, night	0	7/7	Current status of day, night.
onlinenum_rtsp	integer	0	6/7	Current number of RTSP connections.
onlinenum_httppush	integer	0	6/7	Current number of HTTP push server connections.
eth_i0	<string>	<blank>	1/7	Get network information from mii-tool.
vi_i<0~(nvi-1)>	<boolean>	0	1/7	Virtual input



				0 => Inactive 1 => Active

### 7.3 digital input behavior define

Group: **di\_i<0~(ndi-1)>**

NAME	VALUE	DEFAULT	SECURITY (get/set)	DESCRIPTION
normalstate	high, low	high	1/1	Indicates open circuit or closed circuit (inactive status)

### 7.4 security

Group: **security**

NAME	VALUE	DEFAULT	SECURITY (get/set)	DESCRIPTION
privilege_camctrl	view, operator, admin	view	1/6	Indicate which privileges and above can control ePTZ
user_i0_name	string[64]	root	6/7	User name of root
user_i<1~20>_name	string[64]	<blank>	6/7	User name
user_i0_pass	password[64]	<blank>	6/6	Root password
user_i<1~20>_pass	password[64]	<blank>	7/6	User password
user_i0_privilege	admin	admin	6/7	Root privilege
user_i<1~20>_privilege	view, operator, admin	<blank>	6/6	User privilege

## 7.5 network

Group: **network**

NAME	VALUE	DEFAULT	SECURITY (get/set)	DESCRIPTION
preprocess	<positive integer>	NULL	6/6	<p>An 32-bit integer, each bit can be set separately as follows:</p> <ul style="list-style-type: none"> <li>Bit 0 =&gt; HTTP service;</li> <li>Bit 1=&gt; HTTPS service;</li> <li>Bit 2=&gt; FTP service;</li> <li>Bit 3 =&gt; Two way audio and RTSP Streaming service;</li> </ul> <p>To stop service before changing its port settings. It's <b>recommended</b> to set this parameter when change a service port to the port occupied by another service currently. Otherwise, the service may fail.</p> <p>Stopped service will auto-start after changing port settings.</p> <p>Ex: Change HTTP port from 80 to 5556, and change RTP port for video from 5556 to 20480. Then, set preprocess=9 to stop both service first. ”/cgi-bin/admin/setparam.cgi? network_preprocess=9&amp;network_http_port=5556 &amp; network_rtp_videoport=20480”</p>
type	lan, pppoe	lan	6/6	Network connection type.
resetip	<boolean>	1	6/6	<p>1 =&gt; Get ipaddress, subnet, router, dns1, dns2 from DHCP server at next reboot.</p> <p>0 =&gt; Use preset ipaddress, subnet, rounter, dns1, and dns2.</p>
ipaddress	<ip address>	<product dependent>	6/6	IP address of server.
subnet	<ip address>	<blank>	6/6	Subnet mask.
router	<ip	<blank>	6/6	Default gateway.

	address>			
dns1	<ip address>	<blank>	6/6	Primary DNS server.
dns2	<ip address>	<blank>	6/6	Secondary DNS server.
wins1	<ip address>	<blank>	6/6	Primary WINS server.
wins2	<ip address>	<blank>	6/6	Secondary WINS server.

## 7.5.1 802.1x

### Subgroup of network: ieee8021x

NAME	VALUE	DEFAULT	SECURITY (get/set)	DESCRIPTION
enable	<boolean>	0	6/6	Enable/disable IEEE 802.1x
eapmethod	eap-peap, eap-tls	eap-peap	6/6	Selected EAP method
identity_peap	String[64]	<blank>	6/6	PEAP identity
identity_tls	String[64]	<blank>	6/6	TLS identity
password	String[200]	<blank>	6/6	Password for TLS
privatekeypassword	String[200]	<blank>	6/6	Password for PEAP
ca_exist	<boolean>	0	6/6	CA installed flag
ca_time	<integer>	0	6/7	CA installed time. Represented in EPOCH
ca_size	<integer>	0	6/7	CA file size (in bytes)
certificate_exist	<boolean>	0	6/6	Certificate installed flag (for TLS)
certificate_time	<integer>	0	6/7	Certificate installed time. Represented in EPOCH
certificate_size	<integer>	0	6/7	Certificate file size (in bytes)
privatekey_exist	<boolean>	0	6/6	Private key installed flag (for TLS)
privatekey_time	<integer>	0	6/7	Private key installed time. Represented in EPOCH
privatekey_size	<integer>	0	6/7	Private key file size (in bytes)

## 7.5.2 QOS

Subgroup of **network: qos\_cos**

NAME	VALUE	DEFAULT	SECURITY (get/set)	DESCRIPTION
enable	<boolean>	0	6/6	Enable/disable CoS (IEEE 802.1p)
vlanid	1~4095	1	6/6	VLAN ID
video	0~7	0	6/6	Video channel for CoS
audio	0~7	0	6/6	Audio channel for CoS
eventalarm	0~7	0	6/6	Event/alarm channel for CoS
management	0~7	0	6/6	Management channel for CoS
eventtunnel	0~7	0	6/6	Event/Control channel for CoS

Subgroup of **network: qos\_dscp**

NAME	VALUE	DEFAULT	SECURITY (get/set)	DESCRIPTION
enable	<boolean>	0	6/6	Enable/disable DSCP
video	0~63	0	6/6	Video channel for DSCP
audio	0~63	0	6/6	Audio channel for DSCP
eventalarm	0~63	0	6/6	Event/alarm channel for DSCP
management	0~63	0	6/6	Management channel for DSCP
eventtunnel	0~63	0	6/6	Event/Control channel for DSCP

## 7.5.3 IPV6

Subgroup of **network: ipv6**

NAME	VALUE	DEFAULT	SECURITY (get/set)	DESCRIPTION
enable	<boolean>	0	6/6	Enable IPv6.
addonipaddress	<ip address>	<blank>	6/6	IPv6 IP address.
addonprefixlen	0~128	64	6/6	IPv6 prefix length.
addonrouter	<ip address>	<blank>	6/6	IPv6 router address.
addondns	<ip address>	<blank>	6/6	IPv6 DNS address.
allowoptional	<boolean>	0	6/6	Allow manually setup of IP address setting.

## 7.5.4 FTP

Subgroup of **network: ftp**

NAME	VALUE	DEFAULT	SECURITY (get/set)	DESCRIPTION
port	21, 1025~65535	21	6/6	Local ftp server port.

## 7.5.5 HTTP

Subgroup of **network: http**

NAME	VALUE	DEFAULT	SECURITY (get/set)	DESCRIPTION
port	80, 1025 ~ 65535	80	6/6	HTTP port.
alternateport	1025~65535	8080	6/6	Alternate HTTP port.
authmode	basic, digest	basic	1/6	HTTP authentication mode.
s0_accessname	string[32]	video.mjpg	1/6	HTTP server push access name for stream 1.
s1_accessname	string[32]	video2.mjpg	1/6	HTTP server push access name for stream 2.
s2_accessname	string[32]	videoany.mjpg	1/6	Http server push access name for stream 3
anonymousviewing	<boolean>	0	1/6	Enable anonymous streaming viewing.

## 7.5.6 HTTPS port

Subgroup of **network: https**

NAME	VALUE	DEFAULT	SECURITY (get/set)	DESCRIPTION
port	443, 1025 ~ 65535	443	6/6	HTTPS port.

## 7.5.7 RTSP

Subgroup of **network**: **rtsp**

NAME	VALUE	DEFAULT	SECURITY (get/set)	DESCRIPTION
port	554, 1025 ~ 65535	554	1/6	RTSP port.
anonymousviewing	<boolean>	0	1/6	Enable anonymous streaming viewing.
authmode	disable, basic, digest	disable	1/6	RTSP authentication mode.
s0_accessname	string[32]	live.sdp	1/6	RTSP access name for stream1.
s1_accessname	string[32]	live2.sdp	1/6	RTSP access name for stream2.
s2_accessname	string[32]	liveany.sdp	1/6	RTSP access name for stream3

### 7.5.7.1 RTSP multicast

Subgroup of **network\_rtsp\_s<0~(n-1)>**: **multicast**, n is stream count

NAME	VALUE	DEFAULT	SECURITY (get/set)	DESCRIPTION
alwaysmulticast	<boolean>	0	4/4	Enable always multicast.
ipaddress	<ip address>	For n=0, 239.128.1.99 For n=1, 239.128.1.100, and so on.	4/4	Multicast IP address.
videoport	1025 ~ 65535	5560+n*2	4/4	Multicast video port.
audioport	1025 ~ 65535	5562+n*2	4/4	Multicast audio port.
ttl	1 ~ 255	15	4/4	Multicast time to live value.

## 7.5.8 RTP port

Subgroup of **network: rtp**

NAME	VALUE	DEFAULT	SECURITY Y (get/set)	DESCRIPTION
videoport	1025 ~ 65535	5556	6/6	Video channel port for RTP.
audioport	1025 ~ 65535	5558	6/6	Audio channel port for RTP.

## 7.5.9 PPPoE

Subgroup of **network: pppoe**

NAME	VALUE	DEFAULT	SECURITY (get/set)	DESCRIPTION
user	string[128]	<blank>	6/6	PPPoE account user name.
pass	password[64]	<blank>	6/6	PPPoE account password.

## 7.6 IP Filter

Group: **ipfilter**

NAME	VALUE	DEFAULT	SECURITY (get/set)	DESCRIPTION
enable	<boolean>	0	6/6	Enable access list filtering.
admin_enable	<boolean>	0	6/6	Enable administrator IP address.
admin_ip	String[44]	<blank>	6/6	Administrator IP address.
maxconnection	1~10	10	6/6	Maximum number of concurrent streaming connection(s).
allow_i<0~9>_start	1.0.0.0 ~ 255.255.255.255	allow_0_start => 1.0.0.0  allow_<1~9>_start => <blank>	6/6	Allowed starting IPv4 address for connection.
allow_i<0~9>_end	1.0.0.0 ~ 255.255.255.255	allow_0_end => 255.255.255.255  allow_<1~9>_end	6/6	Allowed ending IPv4 address for connection.

		=> <blank>		
deny_i<0~9>_start	1.0.0.0 ~ 255.255.255.255	<blank>	6/6	Denied starting IPv4 address for connection.
deny_i<0~9>_end	1.0.0.0 ~ 255.255.255.255	<blank>	6/6	Denied ending IPv4 address for connection.
ipv6_allow_i<0~9>	String[44]	ipv6_allow_i0 => ::/0 ipv6_allow_i<1~9> => <blank>	6/6	Allowed IPv6 address for connection.
ipv6_deny_i<0~9>	String[44]	<blank>	6/6	Denied IPv6 address for connection.

### 7.6.1 ipfilter for ONVIF

Group: ipfilter

NAME	VALUE	DEFAULT	SECURITY (get/set)	DESCRIPTION
enable	<boolean>	0	6/6	Enable access list filtering.
admin_enable	<boolean>	0	6/6	Enable administrator IP address.
admin_ip	String[43]	<blank>	6/6	Administrator IP address.
maxconnection	1~10	10	6/6	Maximum number of concurrent streaming connection(s).
type	0, 1	1	6/6	Ipfilter policy : 0 => allow 1 => deny
ipv4list_i<0~9>	Single address: <ip address> Network address: <ip address / network mask> Range address:<start ip address - end ip address>	<blank>	6/6	IPv4 address list.
ipv6list_i<0~9>	String[43]	<blank>	6/6	IPv6 address list.



## 7.7 video input

Group: **videoin**

NAME	VALUE	DEFAULT	SECURITY (get/set)	DESCRIPTION
cmosfreq	50, 60	60	4/4	CMOS frequency.
whitebalance	auto, manual, rbgain	auto	4/4	“auto” indicates auto white balance. “manual” indicates keep current value. “rbgain” indicates using rgain and gbain.
exposurelevel	0~8	4	4/4	Exposure level
color	0, 1	1	4/4	0 =>monochrome 1 => color
flip	<boolean>	0	4/4	Flip the image.
mirror	<boolean>	0	4/4	Mirror the image.
text	string[16]	<blank>	1/4	Enclose caption.
imprinttimestamp	<boolean>	0	4/4	Overlay time stamp on video.

### 7.7.1 video input setting per channel

Group: **videoin\_c<0~(n-1)>** for n channel products, and m is stream number

NAME	VALUE	DEFAULT	SECURITY (get/set)	DESCRIPTION
whitebalance	auto, manual, rbgain	auto	4/4	“auto” indicates auto white balance. “manual” indicates keep current value. “rbgain” indicates using rgain and gbain.
rgain	0~100	16	4/4	Manual set rgain value of gain control setting.
bgain	0~100	21	4/4	Manual set bgain value of gain control setting.
exposurelevel	0~8	4	4/4	Exposure level
wdr_mode	0~1	1	4/4	WDR Pro. 0: off

				1: on
wdr_strength	0~2	1	4/4	WDR Pro strength. 0: low 1: medium 2: high
cmosfreq	50, 60	60	4/4	CMOS frequency.
maxgain	0~5	5	4/4	Manual set maximum gain value.
color	0, 1	1	4/4	0 => monochrome 1 => color
flip	<boolean>	0	4/4	Flip the image.
mirror	<boolean>	0	4/4	Mirror the image.
ptzstatus	<integer>	2	1/7	A 32-bit integer, each bit can be set separately as follows: Bit 0 => Support camera control function; 0(not support), 1(support) Bit 1 => <b>Built-in</b> or <b>external</b> camera; 0 (external), 1(built-in) Bit 2 => Support <b>pan</b> operation; 0(not support), 1(support) Bit 3 => Support <b>tilt</b> operation; 0(not support), 1(support) Bit 4 => Support <b>zoom</b> operation; 0(not support), 1(support) Bit 5 => Support <b>focus</b> operation; 0(not support), 1(support)
text	string[64]	<blank>	1/4	Enclose caption.
imprinttimestamp	<boolean>	0	4/4	Overlay time stamp on video.
textonvideo_position	top, bottom	top	4/4	Position of timestamp and video title on image
textonvideo_size	15,25,30	15	4/4	Timestamp and video title font-size

s<0~(m-1)>_codectype	mjpeg, h264	h264	1/4	Video codec type. svc is only supported with stream 0.
s<0~(m-1)>_resolution	176x144, 384x216, 640x360, 1280x720, 1280x800	1280x800	1/4	Video resolution in pixels.
s<0~(m-1)>_h264_intra period	250, 500, 1000, 2000, 3000, 4000	1000	4/4	Intra frame period in milliseconds.
s<0~(m-1)>_h264_prio rity policy	framerate, imagequality	framerate	4/4	The policy to apply when the target bit rate is not sufficient to satisfy current encoded conditions. “framerate” indicates frame rate first. “imagequality” indicates image quality first.
s<0~(m-1)>_h264_rate controlmode	cbr, vbr	cbr	4/4	cbr, constant bitrate vbr, fix quality
s<0~(m-1)>_h264_ quant	1~5,99, 100	3	4/4	Quality of video when choosing vbr in “ratecontrolmode”. 1 = worst quality, 5 = best quality. 100: Use the quality level in "qpercent" 99: Use the quality level in "qvalue"
s<0~(m-1)>_h264_ qpercent	1~100	45	4/4	Set quality by percentage. 1: Worst quality 100: Best quality (s<0~(m-1)>_h264_ quant = 100)
s<0~(m-1)>_h264_ qvalue	0~51	29	4/4	Manual video quality level input. (s<0~(m-1)>_h264_ quant =

				99)
s<0~(m-1)>_h264_bitrate	1000~4000000 0	3000000	4/4	Set bit rate in bps when choosing cbr in "ratecontrolmode".
s<0~(m-1)>_h264_maxframe	1~30	30	1/4	Set maximum frame rate in fps (for h264).
s<0~(m-1)>_h264_profile	0~2	1	1/4	Indicate H264 profiles 0: baseline 1: main profile 2: high profile
s<0~(m-1)>_mpeg_prioritypolicy	framerate, imagequality	framerate	4/4	The policy to apply when the target bit rate is not sufficient to satisfy current encoded conditions. "framerate" indicates frame rate first. "imagequality" indicates image quality first.
s<0~(m-1)>_mpeg_ratecontrolmode	cbr, vbr	vbr	4/4	cbr, constant bitrate vbr, fix quality
s<0~(m-1)>_mpeg_quant	1~5, 99, 100	3	4/4	Quality of JPEG video. 1 = worst quality, 5 = best quality. 100: Use the quality level in "qpercent" 99: Use the quality level in "qvalue"
s<0~(m-1)>_mpeg_maxframe	1~30	30	1/4	Set maximum frame rate in fps (for JPEG).
s<0~(m-1)>_mpeg_qvalue	10~200	49	4/4	Manual video quality level input. (s<0~(m-1)>_mpeg_quant = 0)
s<0~(m-1)>_mpeg_qpercent	1~100	49	4/4	Set quality by percentage. 1: Worst quality 100: Best quality (s<0~(m-1)>_mpeg_quant = 100)
s<0~(m-1)>_mpeg_bitrate	1000~400000	6000000	4/4	Set bit rate in bps when

	00			choosing cbr in “ratecontrolmode”.
s<0~(m-1)>_forcei	1	N/A	7/6	Force I frame.

### 7.7.1.1 Alternative video input profiles per channel

In addition to the primary setting of video input, there can be alternative profile video input setting for each channel which might be for different scene of light (daytime or nighttime).

Group: **videoin\_profile\_i<0~(m-1)>**

NAME	VALUE	DEFAULT	SECURITY (get/set)	DESCRIPTION
enable	<boolean>	0	4/4	Enable/disable this profile setting
policy	day, night, schedule	night	4/4	The mode which the profile is applied to.
begintime	hh:mm	18:00	4/4	Begin time of schedule mode.
endtime	hh:mm	06:00	4/4	End time of schedule mode.
exposurelevel	0~8	4	4/4	Exposure level
maxgain	0~5	5	4/4	Manual set maximum gain value.
whitebalance	auto, manual, rbgain	auto	4/4	“auto” indicates auto white balance. “manual” indicates keep current value. “rbgain” indicates using rgain and gbain.
rgain	0~100	16	4/4	Manual set rgain value of gain control setting.
bgain	0~100	21	4/4	Manual set bgain value of gain control setting.
wdr_mode	0~1	1	4/4	WDR Pro. 0: off 1: on
wdr_strength	0~2	1	4/4	WDR Pro strength. 0: low 1: medium 2: high

## 7.8 IR cut control

Group: **ircutcontrol**

NAME	VALUE	DEFAULT	SECURITY (get/set)	DESCRIPTION
mode	auto, day, night, di, schedule	auto	6/6	Set IR cut control mode
daymodebegin time	00:00~23:59	07:00	6/6	Day mode begin time
daymodeend time	00:00~23:59	18:00	6/6	Day mod end time
disableirled	<boolean>	0	6/6	Enable/disable built-in IR led
bwmode	<boolean>	1	6/6	Switch to B/W in night mode if enabled
sensitivity	low, normal, high	normal	6/6	Sensitivity of light sensor

## 7.9 image setting per channel

Group: **image\_c<0~(n-1)>** for n channel products

NAME	VALUE	DEFAULT	SECURITY (get/set)	DESCRIPTION
brightness	-5 ~ 5	-5	4/4	Adjust brightness of image according to mode settings.
saturation	-5 ~ 5, 100	100	4/4	Adjust saturation of image according to mode settings.
contrast	-5 ~ 5	0	4/4	Adjust contrast of image according to mode settings.
sharpness	-3 ~ 3, 100	100	4/4	Adjust sharpness of image according to mode settings.

saturationpercent	0 ~ 100	50	4/4	Adjust saturation of image by percentage. Less 0 <-> 100 More saturation
sharpnesspercent	0~100	50	4/4	Adjust sharpness of image by percentage. Softer 0 <-> 100 Sharper
dnr_mode	0~1	0	4/4	3D noise reduction. 0: off 1: on
dnr_strength	1~100	50	4/4	3D noise reduction strength. 0: low 1: medium 2: high
lowlightmode	<boolean>	1	4/4	Enable/disable low light mode.

## 7.10 Audio input per channel

Group: **audioin\_c<0~(n-1)>** for n channel products

NAME	VALUE	DEFAULT	SECURITY (get/set)	DESCRIPTION
mute	0, 1	0	4/4	Enable audio mute.
gain	0~100	65	4/4	Gain of input.
s<0~(m-1)>_codectype	g711, g726	g711	4/4	Set audio codec type for input.
s<0~(m-1)>_g711_mode	pcmu, pcma	pcmu	4/4	Set G.711 mode.
s<0~(m-1)>_g726_bitrate	16000, 24000, 32000, 40000	16000	4/4	Set G.726 bitrate in bps.
s<0~(m-1)>_g726_bitstreampackingmode	little, big	little	4/4	Set G.726 bit streaming packing mode
s<0~(m-1)>_g726_vlcmode	0, 1	0	4/4	Enable vlcmode for G.726

## 7.11 Time Shift settings

Group: **timeshift**, c for n channel products, m is stream number

NAME	VALUE	DEFAULT	SECURITY	DESCRIPTION
		T	Y (get/set)	
enable	<boolean>	0	4/4	Enable time shift streaming.
c<0~(n-1)>_s<0~(m-1)>_allow	<boolean>	0	4/4	Enable time shift streaming for specific stream.

## 7.12 Motion detection settings

Group: **motion\_c<0~(n-1)>** for n channel product

NAME	VALUE	DEFAULT	SECURITY	DESCRIPTION
			(get/set)	
enable	<boolean>	0	4/4	Enable motion detection.
win_i<0~2>_enable	<boolean>	0	4/4	Enable motion window 1~3.
win_i<0~2>_name	string[14]	<blank>	4/4	Name of motion window 1~3.
win_i<0~2>_left	0 ~ 320	0	4/4	Left coordinate of window position.
win_i<0~2>_top	0 ~ 240	0	4/4	Top coordinate of window position.
win_i<0~2>_width	0 ~ 320	0	4/4	Width of motion detection window.
win_i<0~2>_height	0 ~ 240	0	4/4	Height of motion detection window.
win_i<0~2>_objsize	0 ~ 100	0	4/4	Percent of motion detection window.
win_i<0~2>_sensitivity	0 ~ 100	0	4/4	Sensitivity of motion detection window.

Group: **motion\_c<0~(n-1)> profile** for m profile and n channel product (capability.nmotionprofile > 0)

NAME	VALUE	DEFAULT	SECURITY	DESCRIPTION
			(get/set)	
i<0~(m-1)>_enable	<boolean>	0	4/4	Enable profile 1 ~ (m-1).
i<0~(m-1)>_policy	day, night,	night	4/4	The mode which the profile is applied to.



	schedule			
i<0~(m-1)>_begintime	hh:mm	18:00	4/4	Begin time of schedule mode.
i<0~(m-1)>_endtime	hh:mm	06:00	4/4	End time of schedule mode.
i<0~(m-1)>_win_i<0~2>_enable	<boolean>	0	4/4	Enable motion window.
i<0~(m-1)>_win_i<0~2>_name	string[14]	<blank>	4/4	Name of motion window.
i<0~(m-1)>_win_i<0~2>_left	0 ~ 320	0	4/4	Left coordinate of window position.
i<0~(m-1)>_win_i<0~2>_top	0 ~ 240	0	4/4	Top coordinate of window position.
i<0~(m-1)>_win_i<0~2>_width	0 ~ 320	0	4/4	Width of motion detection window.
i<0~(m-1)>_win_i<0~2>_height	0 ~ 240	0	4/4	Height of motion detection window.
i<0~(m-1)>_win_i<0~2>_objsize	0 ~ 100	0	4/4	Percent of motion detection window.
i<0~(m-1)>_win_i<0~2>_sensitivity	0 ~ 100	0	4/4	Sensitivity of motion detection window.

## 7.13 Tampering detection settings

Group: **tampering\_c<0~(n-1)>** for n channel product

NAME	VALUE	DEFAULT	SECURITY (get/set)	DESCRIPTION
enable	<boolean>	0	4/4	Enable or disable tamper detection.
duration	10 ~ 600	10	4/4	If tampering value exceeds the 'threshold' for more than 'duration' second(s), then tamper detection is triggered.

## 7.14 DDNS

Group: **ddns**

NAME	VALUE	DEFAULT	SECURITY (get/set)	DESCRIPTION
enable	<boolean>	0	6/6	Enable or disable the dynamic DNS.
provider	Safe100, DyndnsDynamic, DyndnsCustom, DynInterfree, CustomSafe100, PeanutHull	DyndnsDynamic	6/6	Safe100 => safe100.net DyndnsDynamic => dyndns.org (dynamic) DyndnsCustom => dyndns.org (custom) DynInterfree => dyn-interfree.it CustomSafe100 => Custom server using safe100 method PeanutHull => PeanutHull
<provider>_hostname	string[128]	<blank>	6/6	Your DDNS hostname.
<provider>_usernameemail	string[64]	<blank>	6/6	Your user name or email to login to the DDNS service provider
<provider>_passwordkey	string[64]	<blank>	6/6	Your password or key to login to the DDNS service provider.
<provider>_servername	string[128]	<blank>	6/6	The server name for safe100. (This field only exists if the provider is customsaf100)

### 7.14.1 Express link

Group: **expresslink**

NAME	VALUE	DEFAULT	SECURITY (get/set)	DESCRIPTION
enable	<boolean>	0	6/6	Enable or disable express link.
state	onlycheck, onlyoffline, checkonline, badnetwork	<blank>	6/6	“onlycheck” : You have to input the host name of your camera and press "Register" button to register it. “onlyoffline” : Express link is active, you can now connect to this camera at expresslink_url. “checkonline” : Express link is not

				active. “badnetwork” : Express Link is not supported under this network environment.
url	string[64]	<blank>	6/6	The URL to connect to this camera by express link.
setparamlevel	0~2	0	6/6	Show log of parameter setting. 0: disable 1: Show log of parameter setting set from external. 2. Show log of parameter setting set from external and internal.

## 7.15 UPnP presentation

Group: **upnppresentation**

NAME	VALUE	DEFAULT	SECURITY (get/set)	DESCRIPTION
enable	<boolean>	1	6/6	Enable or disable the UPnP presentation service.

## 7.16 UPnP port forwarding

Group: **upnpportforwarding**

NAME	VALUE	DEFAULT	SECURITY (get/set)	DESCRIPTION
enable	<boolean>	0	6/6	Enable or disable the UPnP port forwarding service.
upnpnatstatus	0~3	0	6/7	The status of UPnP port forwarding, used internally. 0 = OK, 1 = FAIL, 2 = no IGD router, 3 = no need for port forwarding

## 7.17 System log

Group: **syslog**

NAME	VALUE	DEFAULT	SECURITY (get/set)	DESCRIPTION
enableremotelog	<boolean>	0	6/6	Enable remote log.
serverip	<IP address>	<blank>	6/6	Log server IP address.
serverport	514, 1025~65535	514	6/6	Server port used for log.
level	0~7	6	6/6	Levels used to distinguish the importance of the information: 0: LOG_EMERG 1: LOG_ALERT 2: LOG_CRIT 3: LOG_ERR 4: LOG_WARNING 5: LOG_NOTICE 6: LOG_INFO 7: LOG_DEBUG

## 7.18 SNMP

Group: **snmp**

NAME	VALUE	DEFAULT	SECURITY (get/set)	DESCRIPTION
v2	0~1	0	6/6	SNMP v2 enabled. 0 for disable, 1 for enable
v3	0~1	0	6/6	SNMP v3 enabled. 0 for disable, 1 for enable
secnamerw	string[31]	Private	6/6	Read/write security name
secnamero	string[31]	Public	6/6	Read only security name
authpwrw	string[8~128]	<blank>	6/6	Read/write authentication password
authpwro	string[8~128]	<blank>	6/6	Read only authentication password
authyperw	MD5,SHA	MD5	6/6	Read/write authentication type
authypero	MD5,SHA	MD5	6/6	Read only authentication type
encryptpwrw	string[8~128]	<blank>	6/6	Read/write passwr

encryptpwro	string[8~128]	<blank>	6/6	Read only password
encrypttyperw	DES	<blank>	6/6	Read/write encryption type
encrypttypero	DES	<blank>	6/6	Read only encryption type
rwcommunity	string[31]	Private	6/6	Read/write community
rocommunity	string[31]	Public	6/6	Ready only community

## 7.19 Layout configuration

Group: **layout**

NAME	VALUE	DEFAULT	SECURITY (get/set)	DESCRIPTION
logo_default	<boolean>	1	1/6	0 => Custom logo 1 => Default logo
logo_link	string[128]	<a href="http://www.vivotek.com">http://www.vivotek.com</a>	1/6	Hyperlink of the logo
logo_powerbyvvtk_hidden	<boolean>	0	1/6	0 => display the power by vivotek logo 1 => hide the power by vivotek logo
theme_option	1~4	1	1/6	1~3: One of the default themes. 4: Custom definition.
theme_color_font	string[7]	#ffffff	1/6	Font color
theme_color_configfont	string[7]	#ffffff	1/6	Font color of configuration area.
theme_color_titlefont	string[7]	#098bd6	1/6	Font color of video title.
theme_color_controlbackground	string[7]	#565656	1/6	Background color of control area.
theme_color_configbackground	string[7]	#323232	1/6	Background color of configuration area.
theme_color_videobackground	string[7]	#565656	1/6	Background color of video area.
theme_color_case	string[7]	#323232	1/6	Frame color
custombutton_manualtrigger_show	<boolean>	1	1/6	Show or hide manual trigger (VI) button in homepage 0 -> Hidden

1 -> Visible

## 7.20 Privacy mask

Group: **privacymask\_c<0~(n-1)>** for n channel product

NAME	VALUE	DEFAULT	SECURITY (get/set)	DESCRIPTION
enable	<boolean>	0	4/4	Enable privacy mask.
win_i<0~4>_enable	<boolean>	0	4/4	Enable privacy mask window.
win_i<0~4>_name	string[14]	<blank>	4/4	Name of the privacy mask window.
win_i<0~4>_left	0 ~ 320	0	4/4	Left coordinate of window position.
win_i<0~4>_top	0 ~ 240	0	4/4	Top coordinate of window position.
win_i<0~4>_width	0 ~ 320	0	4/4	Width of privacy mask window.
win_i<0~4>_height	0 ~ 240	0	4/4	Height of privacy mask window.

## 7.21 Capability

Group: **capability**

NAME	VALUE	DEFAULT	SECURITY (get/set)	DESCRIPTION
api_httpversion	0200a	0200a	0/7	The HTTP API version.
bootuptime	<positive integer>	60	0/7	Server bootup time.
nir	0, <positive integer>	1	0/7	Number of IR interfaces. (Recommend to use ir for built-in IR and extir for external IR)
npir	0, <positive integer>	0	0/7	Number of PIRs.
ndi	0, <positive integer>	1	0/7	Number of digital inputs.

	integer>			
nvi	0, <positive integer>	3	0/7	Number of virtual inputs (manual trigger)
ndo	0, <positive integer>	0	0/7	Number of digital outputs.
naudioin	0, <positive integer>	0	0/7	Number of audio inputs.
naudioout	0, <positive integer>	0	0/7	Number of audio outputs.
nvideoin	<positive integer>	1	0/7	Number of video inputs.
nvideoinprofile	<positive integer>	1	0/7	Number of video input profiles.
nmediastream	<positive integer>	2	0/7	Number of media stream per channels.
naudiosetting	<positive integer>	0	0/7	Number of audio settings per channel.
nuart	0, <positive integer>	0	0/7	Number of UART interfaces.
nmotion	0, <positive integer>	3	0/7	Number of motion window.
nmotionprofile	0, <positive integer>	1	0/7	Number of motion profiles.
ptzenabled	0, <positive integer>	0	0/7	An 32-bit integer, each bit can be set separately as follows: Bit 0 => Support camera control function; 0(not support), 1(support) Bit 1 => Built-in or external video source; 0(external), 1(built-in) Bit 2 => Support pan operation, 0(not support),

				<p>1(support)            Bit 3 =&gt; Support tilt operation; 0(not support), 1(support)            Bit 4 =&gt; Support zoom operation;            0(not support), 1(support)            Bit 5 =&gt; Support focus operation;            0(not support), 1(support)            Bit 6 =&gt; Support iris operation;            0(not support), 1(support)            Bit 7 =&gt; External or built-in PT; 0(built-in), 1(external)            Bit 8 =&gt; Invalidate bit 1 ~ 7;            0(bit 1 ~ 7 are valid), 1(bit 1 ~ 7 are invalid)            Bit 9 =&gt; Reserved bit; Invalidate lens_pan, Lens_tilt, lens_zoon, lens_focus, len_iris.            0(fields are valid), 1(fields are invalid)            Examples:            PT8133: 0b1111            SD8362: 0b111111            VS8102: 0b10111101</p>
windowless	<boolean>	1	0/7	Indicate whether to support windowless plug-in.
eptz	0, <positive integer>	1	0/7	<p>A 32-bit integer, each bit can be set separately as follows:            Bit 0 =&gt; stream 1 supports ePTZ or not.            Bit 1 =&gt; stream 2 supports</p>



				ePTZ or not. The rest may be deduced by analogy
remotefocus	<boolean>	0	0/7	Indicate whether to support remote focus function.
npreset	0, <positive integer>	20	0/7	Number of preset locations.
protocol_https	< boolean >	1	0/7	Indicate whether to support HTTP over SSL.
protocol_rtsp	< boolean >	1	0/7	Indicate whether to support RTSP.
protocol_sip	<boolean>	0	0/7	Indicate whether to support SIP.
protocol_maxconnection	<positive integer>	10	0/7	The maximum allowed simultaneous connections.
protocol_maxgenconnection	<positive integer>	10	0/7	The maximum general streaming connections .
protocol_maxmegaconnection	<positive integer>	10	0/7	The maximum megapixel streaming connections.
protocol_rtp_multicast_scalable	<boolean>	1	0/7	Indicate whether to support scalable multicast.
protocol_rtp_multicast_backchannel	<boolean>	0	0/7	Indicate whether to support backchannel multicast.
protocol_rtp_tcp	<boolean>	1	0/7	Indicate whether to support RTP over TCP.
protocol_rtp_http	<boolean>	1	0/7	Indicate whether to support RTP over HTTP.
protocol_spush_mjpeg	<boolean>	1	0/7	Indicate whether to support server push MJPEG.
protocol_snmp	<boolean>	1	0/7	Indicate whether to support SNMP.
protocol_ipv6	<boolean>	1	0/7	Indicate whether to support IPv6.
protocol_pppoe	<boolean>	1	0/7	Indicate whether to support PPPoE.

protocol_ieee8021x	<boolean>	1	0/7	Indicate whether to support IEEE802.1x.
protocol_qos_cos	<boolean>	1	0/7	Indicate whether to support CoS.
protocol_qos_dscp	<boolean>	1	0/7	Indicate whether to support QoS/DSCP.
protocol_ddns	<boolean>	1	0/7	Indicate whether to support DDNS.
videoin_type	0, 1, 2	2	0/7	0 => Interlaced CCD 1 => Progressive CCD 2 => CMOS
videoin_resolution	<a list of available resolution separated by commas>	176x144,384x216,640x360,1280x720,1280x800 0	0/7	Available resolutions list.
videoin_nresolution	< number of available resolution list>	5	0/7	Available resolutions list.
videoin_maxframerate	<a list of available maximum frame rate separated by commas> <product dependent>	30,30,30,30,30	0/7	Available maximum frame list.
videoin_mjpeg_maxframerate	<a list of available maximum frame rate separated by commas>	30,30,30,30,30	0/7	Available maximum frame list.
videoin_h264_maxframerate	<a list of available maximum frame rate separated by commas>	30,30,30,30,30	0/7	Available maximum frame list.

videoin_streamcodec	< 1 ~ 15, 1~15 (2 streams) >	6,6	0/7	Available stream codectype (Bit 0 -> mpeg4, Bit 1 -> mjpeg, Bit 2 -> h264, Bit 3 -> svc).
videoin_fov	<a list of available crop size separated by commas>	1280x800	0/7	Available crop size list.
videoin_codec	mjpeg, h264	mjpeg, h264	0/7	Available codec list.
videoin_flexiblebitrate	<boolean>	1	0/7	Indicate whether to support flexible bitrate.
timeshift	<boolean>	1	0/7	Indicate whether to support time shift caching stream.
audio_aec	<boolean>	0	0/7	Indicate whether to support acoustic echo cancellation.
audio_mic	<boolean>	1	0/7	Indicate whether to support built-in microphone input.
audio_extmic	<boolean>	0	0/7	Indicate whether to support external microphone input.
audio_linein	<boolean>	0	0/7	Indicate whether to support external line input. (It will be replaced by audio_mic and audio_extmic.)
audio_lineout	<boolean>	0	0/7	Indicate whether to support line output.
audio_headphoneout	<boolean>	0	0/7	Indicate whether to support headphone output.
audioin_codec	g711, g726	g711, g726	0/7	Available codec list for audio input.
audioout_codec	g711	<blank>	0/7	Available codec list for SIP.

uart_httptunnel	<boolean>	0	0/7	Indicate whether to support HTTP tunnel for UART transfer.
camctrl_httptunnel	<boolean>	0	0/7	The attribute indicates whether sending camera control commands through HTTP tunnel is supported. 0: Not supported 1: Supported
camctrl_privilege	<boolean>	1	0/7	Indicate whether to support “Manage Privilege” of PTZ control in the Security page. 1: support both /cgi-bin/camctrl/camctrl.cgi and /cgi-bin/viewer/camctrl.cgi 0: support only /cgi-bin/viewer/camctrl.cgi
transmission_mode	Tx, Rx, Both	Tx	0/7	Indicate transmission mode of the machine: TX = server, Rx = receiver box, Both = DVR.
network_wire	<boolean>	1	0/7	Indicate whether to support Ethernet.
network_wireless	<boolean>	0	0/7	Indicate whether to support wireless.
derivative_brand	<boolean>	1	0/7	Indicate whether to support the upgrade function for the derivative brand. For example, if the value is true, the VVTK product can be upgraded to VVXX. (TCVV<->TCXX is excepted)
evctrlchannel	<boolean>	1	0/7	Indicate whether to

				support HTTP tunnel for event/control transfer.
joystick	<boolean>	1	0/7	Indicate whether to support joystick control.
storage_dbenabled	<boolean>	1	0/7	Media files are indexed in database.
nanystream	0, <positive integer>	1	0/7	number of any media stream per channel
iva	<boolean>	0	0/7	Indicate whether to support Intelligent Video analysis
ir	<boolean>	1	0/7	Indicate whether to support built-in IR led.
extir	<boolean>	0	0/7	Indicate whether to support external IR led.
whitelight	<boolean>	0	0/7	Indicate whether to support white light led.
iris	<boolean>	0	0/7	Indicate whether to support iris control.
tampering	<boolean>	1	0/7	Indicate whether to support tampering detection.
temperature	<boolean>	0	0/7	Indicate whether to support temperature detection.
version_onvifdaemon	<string>	1.7.1.1	0/7	Indicate ONVIF daemon version
version_onvifevent	<string>	1.1.0.9	0/7	Indicate ONVIF event version
media_totalspace	<positive integer>	20000	0/7	Available memory space (KB) for media.
media_snapshot_sizepersecond	<positive integer>	500	0/7	Maximum size (KB) of one snapshot image.
media_snapshot_maxpreevent	<positive integer>	7	0/7	Maximum snapshot number before event occurred.
media_snapshot_maxpostevent	<positive integer>	7	0/7	Maximum snapshot number after event occurred.

media_videoclip_maxsize	<positive integer>	4096	0/7	Maximum size (KB) of a videoclip.
media_videoclip_maxlength	<positive integer>	20	0/7	Maximum length (second) of a videoclip.
media_videoclip_maxpreevent	<positive integer>	9	0/7	Maximum duration (second) after event occurred in a videoclip.
localstorage_manageable	<boolean>	1	0/7	Indicate whether manageable local storage is supported.
localstorage_seamless	<boolean>	1	0/7	Indicate whether seamless recording is supported.
localstorage_modnum	0, <positive integer>	2	0/7	The maximum MOD connection numbers.
localstorage_slconnnum	0, <positive integer>	1	0/7	The maximum seamless connection number.
adaptiverecording	<boolean>	1	0/7	Indicate whether to support adaptive recording.
adaptivestreaming	<boolean>	1	0/7	Indicate whether to support adaptive streaming.
vadp	<positive integer>	7	0/7	An 32-bit integer, each bit can be set separately as follows: Bit 0 => VADP interface Bit 1 => Capture video raw data Bit 2 => Support encode jpeg Bit 3 => Audio Bit 4 => Event

Group: **capability\_image\_c<n>**, where n = channel index from 0 ~ "capability\_nvideoin"-1

NAME	VALUE	DEFAULT	SECURITY (get/set)	DESCRIPTION
------	-------	---------	--------------------	-------------

wdrc	0, 1	0	0/7	0: Non-support WDR Enhanced 1: Support WDR Enhanced
wdr	0, 1	1	0/7	0: Non-support WDR Pro 1: Support WDR Pro
dnr	0, 1	1	0/7	0: Non-support 3D noise reduction 1: Support 3D noise reduction
iristype	piris, dciris, -	-	0/7	Indicate iris type. "piris": P-Iris "dciris": DC-Iris "-": No Iris control support * Note: For some cameras, this value may be varied depending on mounted lens.
focusassist	0, 1	0	0/7	0: Non-support focus assistance 1: Support focus assistance
remotefocus	0, 1	0	0/7	0: Non-support remote focus 1: Support remote focus

## 7.22 Customized event script

Group: `event_customtaskfile_i<0~2>`

PARAMETER	VALUE	Default	SECURITY (get/set)	DESCRIPTION
name	string[40]	NULL	6/6	Custom script identification of this entry.
date	string[20]	NULL	6/6	Date of custom script.
time	string[20]	NULL	6/6	Time of custom script.

## 7.23 Event setting

Group: event\_i<0~2>

PARAMETER	VALUE	Default	SECURITY (get/set)	DESCRIPTION
name	string[40]	NULL	6/6	Identification of this entry.
enable	0, 1	0	6/6	Enable or disable this event.
priority	0, 1, 2	1	6/6	Indicate the priority of this event: “0” = low priority “1” = normal priority “2” = high priority
delay	1~999	10	6/6	Delay in seconds before detecting the next event.
trigger	boot, di, motion, seq, renotify, tampering, vi	boot	6/6	Indicate the trigger condition: “boot” = System boot “di”= Digital input “motion” = Video motion detection “seq” = Periodic condition “renotify” = Recording notification. “tampering” = Tamper detection. “vi”= Virtual input (Manual trigger)
triggerstatus	String[40]	triggerstatus	6/6	The status for event trigger
di	0, 1	1	6/6	Indicate the source id of di trigger. This field is required when trigger condition is “di”. One bit represents one digital input. The LSB indicates DI 0.
vi	0~7	0	6/6	Indicate the source id of vi trigger. This field is required when trigger condition is “vi”. One bit represents one digital input. The LSB indicates VI 0.
tampering	0 ~ 255	0	6/6	Indicate the source of the tampering detection. Each bit represents one channel, and the LSB indicates channel 1.



mdwin	0~7	0	6/6	<p>Indicate the source window id of motion detection.</p> <p>This field is required when trigger condition is “md”.</p> <p>One bit represents one window.</p> <p>The LSB indicates the 1<sup>st</sup> window.</p> <p>For example, to detect the 1<sup>st</sup> and 3<sup>rd</sup> windows, set mdwin as 5.</p>
mdwin0	0~7	0	6/6	<p>Similar to mdwin. The parameter takes effect when profile 1 of motion detection is enabled.</p>
inter	1~999	1	6/6	<p>Interval of snapshots in minutes.</p> <p>This field is used when trigger condition is “seq”.</p>
weekday	0~127	127	6/6	<p>Indicate which weekday is scheduled.</p> <p>One bit represents one weekday.</p> <p>bit0 (LSB) = Saturday</p> <p>bit1 = Friday</p> <p>bit2 = Thursday</p> <p>bit3 = Wednesday</p> <p>bit4 = Tuesday</p> <p>bit5 = Monday</p> <p>bit6 = Sunday</p> <p>For example, to detect events on Friday and Sunday, set weekday as 66.</p>
begintime	hh:mm	00:00	6/6	<p>Begin time of the weekly schedule.</p>
endtime	hh:mm	24:00	6/6	<p>End time of the weekly schedule.</p> <p>(00:00 ~ 24:00 sets schedule as always on)</p>
action_cf_enable	0, 1	0	6/6	<p>Enable media write on CF or other local storage media</p>
action_cf_folder	string[128]	NULL	6/6	<p>Path to store media.</p>
action_cf_media	NULL, 0~4	NULL	6/6	<p>Index of the attached media.</p>
action_cf_datefolder	<boolean>	1	6/6	<p>Enable this to create folders by date, time, and hour automatically.</p>

action_cf_backup	<boolean>	0	6/6	Enable the capability of backing up recorded files to the SD card when network is lost. 0: Disabled 1: Enabled
action_server_i<0~4>_enable	0, 1	0	6/6	Enable or disable this server action.
action_server_i<0~4>_media	NULL, 0~4	NULL	6/6	Index of the attached media.
action_server_i<0~4>_datefolder	<boolean>	0	6/6	Enable this to create folders by date, time, and hour automatically.
action_server_i<0~4>_foldername	string[40]	%Y%M%D%H	6/6	The template of the folder name to be created. Slashes can be used in the template, and following placeholders can also be used: %Y: Year (e.g. 2010) %M: Month %D: Date %H: Hour

## 7.24 Server setting for event action

Group: **server\_i<0~4>**

PARAMETER	VALUE	DEFAULT	SECURITY (get/set)	DESCRIPTION
name	string[40]	NULL	6/6	Identification of this entry
type	email, ftp, http, ns	email	6/6	Indicate the server type: “email” = email server “ftp” = FTP server “http” = HTTP server “ns” = network storage
http_url	string[128]	http://	6/6	URL of the HTTP server to upload.
http_username	string[64]	NULL	6/6	Username to log in to the server.
http_passwd	string[64]	NULL	6/6	Password of the user.
ftp_address	string[128]	NULL	6/6	FTP server address.
ftp_username	string[64]	NULL	6/6	Username to log in to the server.
ftp_passwd	string[64]	NULL	6/6	Password of the user.

ftp_port	0~65535	21	6/6	Port to connect to the server.
ftp_location	string[128]	NULL	6/6	Location to upload or store the media.
ftp_passive	0, 1	1	6/6	Enable or disable passive mode. 0 = disable passive mode 1 = enable passive mode
email_address	string[128]	NULL	6/6	Email server address.
email_sslmode	0, 1	0	6/6	Enable support SSL.
email_port	0~65535	25	6/6	Port to connect to the server.
email_username	string[64]	NULL	6/6	Username to log in to the server.
email_passwd	string[64]	NULL	6/6	Password of the user.
email_senderemail	string[128]	NULL	6/6	Email address of the sender.
email_recipientemail	string[128]	NULL	6/6	Email address of the recipient.
ns_location	string[128]	NULL	6/6	Location to upload or store the media.
ns_username	string[64]	NULL	6/6	Username to log in to the server.
ns_passwd	string[64]	NULL	6/6	Password of the user.
ns_workgroup	string[64]	NULL	6/6	Workgroup for network storage.

## 7.25 Media setting for event action

Group: **media\_i<0~4>** (media\_freespace is used internally.)

PARAMETER	VALUE	DEFAULT	SECURITY (get/set)	DESCRIPTION
name	string[40]	NULL	6/6	Identification of this entry
type	snapshot, systemlog, videoclip, recordmsg	snapshot	6/6	Media type to send to the server or store on the server.
snapshot_source	0~1	0	6/6	Indicate the source of media stream. 0 means the first stream. 1 means the second stream.
snapshot_prefix	string[16]	<blank>	6/6	Indicate the prefix of the filename.

snapshot_datesuffix	0, 1	0	6/6	Add date and time suffix to filename: 1 = Add date and time suffix. 0 = Do not add.
snapshot_preevent	0 ~ 7	1	6/6	Indicates the number of pre-event images.
snapshot_postevent	0 ~ 7	1	6/6	The number of post-event images
videoclip_source	0~1	0	6/6	Indicate the source of media stream. 0 means the first stream. 1 means the second stream.
videoclip_prefix	string[16]	<blank>	6/6	Indicate the prefix of the filename.
videoclip_preevent	0 ~ 9	0	6/6	Indicates the time for pre-event recording in seconds.
videoclip_maxduration	1 ~ 20	5	6/6	Maximum duration of one video clip in seconds.
videoclip_maxsize	50 ~ 4096	500	6/6	Maximum size of one video clip file in Kbytes.

## 7.26 Recording

Group: **recording\_i<0~1>**

PARAMETER	VALUE	DEFAULT	SECURITY (get/set)	DESCRIPTION
name	string[40]	NULL	6/6	Identification of this entry.
enable	0, 1	0	6/6	Enable or disable this recording.
priority	0, 1, 2	1	6/6	Indicate the priority of this recording: “0” indicates low priority. “1” indicates normal priority. “2” indicates high priority.
source	0,1	0	6/6	Indicate the source of media stream. 0 means the first stream. 1 means the second stream and so on.
limitsize	0,1	0	6/6	0: Entire free space mechanism 1: Limit recording size mechanism

cyclic	0,1	0	6/6	0: Disable cyclic recording 1: Enable cyclic recording
notify	0,1	1	6/6	0: Disable recording notification 1: Enable recording notification
notifyserver	0~31	0	6/6	Indicate which notification server is scheduled. One bit represents one application server (server_i0~i4). bit0 (LSB) = server_i0. bit1 = server_i1. bit2 = server_i2. bit3 = server_i3. bit4 = server_i4. For example, enable server_i0, server_i2, and server_i4 as notification servers; the notifyserver value is 21.
weekday	0~127	127	6/6	Indicate which weekday is scheduled. One bit represents one weekday. bit0 (LSB) = Saturday bit1 = Friday bit2 = Thursday bit3 = Wednesday bit4 = Tuesday bit5 = Monday bit6 = Sunday For example, to detect events on Friday and Sunday, set weekday as 66.
begintime	hh:mm	00:00	6/6	Start time of the weekly schedule.
endtime	hh:mm	24:00	6/6	End time of the weekly schedule. (00:00~24:00 indicates schedule always on)
prefix	string[16]	<blank>	6/6	Indicate the prefix of the filename.
cyclesize	100~	100	6/6	The maximum size for cycle recording in Kbytes when choosing to limit recording size.

reserveamount	0~15000000	100	6/6	The reserved amount in Mbytes when choosing cyclic recording mechanism.
dest	cf, 0~4	cf	6/6	The destination to store the recorded data. “cf” means local storage (SD card). “0~4” means the index of the network storage.
cffolder	string[128]	NULL	6/6	Folder name.
trigger	schedule, networkfail	schedule	6/6	The event trigger type schedule: The event is triggered by schedule networkfail: The event is triggered by the failure of network connection.
adaptive_enable	0,1	0	6/6	Indicate whether the adaptive recording is enabled
adaptive_preevent	0~9	5	6/6	Indicate when is the adaptive recording started before the event trigger point (seconds)
adaptive_postevent	0~10	5	6/6	Indicate when is the adaptive recording stopped after the event trigger point (seconds)
maxsize	100~900	100	6/6	Unit: Mega bytes. When this condition is reached, recording file is truncated.
maxduration	60~3600	60	6/6	Unit: Second When this condition is reached, recording file is truncated.

## 7.27 HTTPS

Group: **https**

NAME	VALUE	DEFAULT	SECURITY (get/set)	DESCRIPTION
enable	<boolean>	0	6/6	To enable or disable secure HTTP.
policy	<Boolean>	0	6/6	If the value is 1, it will force HTTP connection redirect to HTTPS connection
method	auto, manual, install	Auto	6/6	auto => Create self-signed certificate automatically. manual => Create self-signed certificate manually. install => Create certificate request and install.
status	-3 ~ 1	0	6/6	Specify the https status. -3 = Certificate not installed -2 = Invalid public key -1 = Waiting for certificate 0 = Not installed 1 = Active
countryname	string[2]	TW	6/6	Country name in the certificate information.
stateorprovincename	string[128]	Asia	6/6	State or province name in the certificate information.
localityname	string[128]	Asia	6/6	The locality name in the certificate information.
organizationname	string[64]	VIVOTEK Inc.	6/6	Organization name in the certificate information.
unit	string[64]	VIVOTEK Inc.	6/6	Organizational unit name in the certificate information.
commonname	string[64]	www.vivotek .com	6/6	Common name in the certificate information.
validdays	0 ~ 3650	3650	6/6	Valid period for the certification.

## 7.28 Storage management setting

Currently it's for local storage (SD card)

Group: **disk\_i<0~(n-1)>** n is the total number of storage devices.

PARAMETER	VALUE	Default	SECURITY (get/set)	DESCRIPTION
name	string[16]	NULL	6/6	Disk name.
cyclic_enabled	<boolean>	0	6/6	Enable cyclic storage method.
autocleanup_enabled	<boolean>	0	6/6	Enable automatic clean up method. Expired and not locked media files will be deleted.
autocleanup_maxage	1~<positive integer>	7	6/6	To specify the expired days for automatic clean up.

## 7.29 Region of interest

Group: **roi\_c<0~(n-1)>** for n channel product, and m is the number of streams which support ROI.

PARAMETER	VALUE	Default	SECURITY (get/set)	DESCRIPTION
s<0~(m-1)>_home	<coordinate>	0,0	1/6	ROI left-top corner coordinate.
s<0~(m-1)>_size	<window size>	1280x800	1/6	ROI width and height. The width value must be multiples of 16 and the height value must be multiples of 8

## 7.30 ePTZ setting

Group: **eptz\_c<0~(n-1)>** for n channel product.

PARAMETER	VALUE	Default	SECURITY (get/set)	DESCRIPTION
osdzoom	<boolean>	1	1/4	Indicates multiple of zoom in is "on-screen display" or not
smooth	<boolean>	1	1/4	Enable the ePTZ "move smoothly" feature
tiltspeed	-5 ~ 5	0	1/7	Tilt speed (It should be set by eCamCtrl.cgi rather than by setparam.cgi.)



panspeed	-5 ~ 5	0	1/7	Pan speed (It should be set by eCamCtrl.cgi rather than by setparam.cgi.)
zoomspeed	-5 ~ 5	0	1/7	Zoom speed (It should be set by eCamCtrl.cgi rather than by setparam.cgi.)
autospeed	1 ~ 5	1	1/7	Auto pan/patrol speed (It should be set by eCamCtrl.cgi rather than by setparam.cgi.)

Group: **eptz\_c<0~(n-1)>\_s<0~(m-1)>** for n channel product and m is the number of streams which support ePTZ.

PARAMETER	VALUE	Default	SECURITY (get/set)	DESCRIPTION
patrolseq	string[120]	<blank>	1/4	The patrol sequence of ePTZ. All the patrol position indexes will be separated by ","
patroldwelling	string[160]	<blank>	1/4	The dwelling time (unit: second) of each patrol point, separated by “;”.
preset_i<0~19>_name	string[40]	<blank>	1/7	Name of ePTZ preset. (It should be set by ePreset.cgi rather than by setparam.cgi.)
preset_i<0~19>_pos	<coordinate>	<blank>	1/7	Left-top corner coordinate of the preset. (It should be set by ePreset.cgi rather than by setparam.cgi.)
preset_i<0~19>_size	<window size>	<blank>	1/7	Width and height of the preset. (It should be set by ePreset.cgi rather than by setparam.cgi.)

## 7.31 Exposure window setting per channel

Group: **exposurewin\_c<0~(n-1)>** for n channel products

NAME	VALUE	DEFAULT	SECURITY (get/set)	DESCRIPTION
mode	auto, custom, blc	auto	4/4	The mode indicates how to decide the exposure. auto: Use full view as the only one exposure window. custom: Use inclusive and exclusive window. blc: Use BLC.
win_i0_enable	<boolean>	1	4/4	Enable or disable the window.
win_i0_policy	0~1	1	4/4	0: Indicate exclusive. 1: Indicate inclusive.
win_i0_home	<coordinate>	80,60	4/4	Left-top corner coordinate of the window. <x,y> => <"0~288", "0~208">
win_i0_size	<window size>	160x120	4/4	Width and height of the window. <wxh> => <"0~320"x"0~240">

Group: **exposurewin\_c<0~(n-1)>\_profile** for m profile and n channel product

NAME	VALUE	DEFAULT	SECURITY (get/set)	DESCRIPTION
i0_mode	auto, custom, blc	auto	4/4	The mode indicates how to decide the exposure. auto: Use full view as the only one exposure window. custom: Use inclusive and exclusive window. blc: Use BLC.
i0_win_i0_enable	<boolean>	1	4/4	Enable or disable the window.

i0_win_i0_policy	0~1	1	4/4	0: Indicate exclusive. 1: Indicate inclusive.
i0_win_i0_home	<coordinate>	80,60	4/4	Left-top corner coordinate of the window. <x,y> => <"0~288", "0~208">
i0_win_i0_size	<window size>	160x120	4/4	Width and height of the window. <wxh> => <"0~320"x"0~240">

## 7.32 Seamless recording setting

Group: seamlessrecording

PARAMETER	VALUE	Default	SECURITY (get/set)	DESCRIPTION
diskmode	seamless, manageable	seamless	1/6	"seamless" indicates enable seamless recording. "manageable" indicates disable seamless recording.
maxconnection	3	3	1/6	Maximum number of connected seamless streaming.
stream	1~2	1	1/6	(Internal used, read only)
output	0~3	2	1/6	(Internal used, read only)
enable	<boolean>	0	1/6	Indicate whether seamless recording is recording to local storage or not at present. (Read only)
guid<0~2>_id	string[127]	<blank>	1/6	The connected seamless streaming ID. (Read only)
guid<0~2>_number	0~3	0	1/6	Number of connected seamless streaming with guid<0~2>_id. (Read only)

## 7.33 VIVOTEK Application Development Platform setting

Group: vadp

NAME	VALUE	DEFAULT	SECURITY (get/set)	DESCRIPTION
version	<string>	1.1.0.0	6/7	Indicate the VADP version.
resource_total_video	<integer>	1	6/7	Indicate total video resource number of the system.
resource_total_audio	<integer>	0	6/7	Indicate total audio resource number of the system.
resource_total_do	<integer>	0	6/7	Indicate total DO resource number of the system.
resource_total_memory	<integer>	24576	6/7	Indicate total available memory size for VADP modules.
resource_total_storage	<integer>	10240	6/7	Indicate total size of the internal storage space for storing VADP modules.
resource_free_video	<integer>	1	6/7	Indicate free video resource number of the system.
resource_free_audio	<integer>	0	6/7	Indicate free audio resource number of the system.
resource_free_do	<integer>	0	6/7	Indicate free DO resource number of the system.
resource_free_memory	<integer>	24576	6/7	Indicate free memory size for VADP modules.
resource_free_storage	<integer>	10240	6/7	Indicate current free storage size for uploading VADP modules.
module_number	<integer>	0	6/7	Record the total module number that already stored in the system.

module_order	string[40]	<blank>	6/6	The execution order of the enabled modules.
module_save2sd	<boolean>	0	6/6	Indicate if the module should be saved to SD card when user want to upload it. If the value is false, save module to the internal storage space and it will occupy storage size.

**Group: vadb\_module\_i<0~(n-1)>**

NAME	VALUE	DEFAULT	SECURITY (get/set)	DESCRIPTION
enable	<boolean>	0	6/6	Indicate if the module is enabled or not. If yes, also add the index of this module to the module_order.
name	string[40]	<blank>	6/6	Module name
url	string[120]	<blank>	6/6	Define the URL string after the IP address if the module provides it own web page.
vender	string[40]	<blank>	6/6	The provider of the module.
vendorurl	string[120]	<blank>	6/6	URL of the vendor.
version	string[40]	<blank>	6/6	Version of the module.
license	string[40]	<blank>	6/6	Indicate the license status of the module.
path	string[40]	<blank>	6/6	Record the storage path of the module.
initscr	string[40]	<blank>	6/6	The script that will handle operation commands from the system.
status	string[40]	<blank>	6/6	Indicate the running status of the module.

## 8. Useful Functions

### 8.1 Query Status of the Digital Input

Note: This request requires Viewer privileges

**Method:** GET/POST

Syntax:

```
http://<servername>/cgi-bin/dido/getdi.cgi?[di0][&di1][&di2][&di3]
```

If no parameter is specified, all of the digital input statuses will be returned.

Return:

```
HTTP/1.0 200 OK\r\n  
Content-Type: text/plain\r\n  
Content-Length: <length>\r\n  
\r\n  
[di0=<state>]\r\n  
[di1=<state>]\r\n  
[di2=<state>]\r\n  
[di3=<state>]\r\n
```

where <state> can be 0 or 1.

**Example:** Query the status of digital input 1 .

Request:

```
http://myserver/cgi-bin/dido/getdi.cgi?di1
```

Response:

```
HTTP/1.0 200 OK\r\n  
Content-Type: text/plain\r\n  
Content-Length: 7\r\n  
\r\n  
di1=1\r\n
```

## 8.2 Capture Single Snapshot

**Note:** This request requires Normal User privileges.

**Method:** GET/POST

Syntax:

```
http://<servername>/cgi-bin/viewer/video.jpg?[channel=<value>][&resolution=<value>]
[&quality=<value>][&streamid=<value>]
```

If the user requests a size larger than all stream settings on the server, this request will fail.

PARAMETER	VALUE	DEFAULT	DESCRIPTION
channel	0~(n-1)	0	The channel number of the video source.
resolution	<available resolution>	0	The resolution of the image.
quality	1~5	3	The quality of the image.
streamid	0~(m-1)	<product dependent>	The stream number.

The server will return the most up-to-date snapshot of the selected channel and stream in JPEG format. The size and quality of the image will be set according to the video settings on the server.

Return:

```
HTTP/1.0 200 OK\r\n
Content-Type: image/jpeg\r\n
[Content-Length: <image size>\r\n]

<binary JPEG image data>
```

## 8.3 Account Management

**Note:** This request requires Administrator privileges.

**Method:** GET/POST

Syntax:

```
http://<servername>/cgi-bin/admin/editaccount.cgi?
method=<value>&username=<name> [&userpass=<value>] [&privilege=<value>]
[&privilege=<value>][...][&return=<return page>]
```

PARAMETER	VALUE	DESCRIPTION
method	Add	Add an account to the server. When using this method, the “username” field is necessary. It will use the default value of other fields if not specified.
	Delete	Remove an account from the server. When using this method, the “username” field is necessary, and others are ignored.
	edit	Modify the account password and privilege. When using this method, the “username” field is necessary, and other fields are optional. If not specified, it will keep the original settings.
username	<name>	The name of the user to add, delete, or edit.
userpass	<value>	The password of the new user to add or that of the old user to modify. The default value is an empty string.
Privilege	<value>	The privilege of the user to add or to modify.
	viewer	Viewer privilege.
	operator	Operator privilege.
	admin	Administrator privilege.
Return	<return page>	Redirect to the page <return page> after the parameter is assigned. The <return page> can be a full URL path or relative path according to the current path. If you omit this parameter, it will redirect to an empty page.



## 8.4 System Logs

**Note:** This request require Administrator privileges.

**Method:** GET/POST

Syntax:

```
http://<servername>/cgi-bin/admin/syslog.cgi
```

Server will return the most up-to-date system log.

Return:

```
HTTP/1.0 200 OK\r\nContent-Type: text/plain\r\nContent-Length: <syslog length>\r\n\r\n<system log information>\r\n
```

## 8.5 Upgrade Firmware

**Note:** This request requires Administrator privileges.

**Method:** POST

Syntax:

```
http://<servername>/cgi-bin/admin/upgrade.cgi
```

Post data:

```
fimage=<file name>[&return=<return page>]\r\n\r\n<multipart encoded form data>
```

Server will accept the file named <file name> to upgrade the firmware and return with <return page> if indicated.

## 8.6 ePTZ Camera Control

**Note:** This request requires camctrl privileges.

**Method:** GET/POST

Syntax:

```
http://<servername>/cgi-bin/camctrl/eCamCtrl.cgi?channel=<value>&stream=<value>
[&move=<value>] – Move home, up, down, left, right
[&auto=<value>] – Auto pan, patrol
[&zoom=<value>] – Zoom in, out
[&zooming=<value>&zs=<value>] – Zoom without stopping, used for joystick
[&vx=<value>&vy=<value>&vs=<value>] – Shift without stopping, used for joystick
[&x=<value>&y=<value>&videosize=<value>&resolution=<value>&stretch=<value>] – Click on
image
(Move the center of image to the coordination (x,y) based on resolution or videosize.)
[ [&speedpan=<value>][&speedtilt=<value>][&speedzoom=<value>][&speedapp=<value>] ] – Set
speeds
[&return=<return page>]
```

**Example:**

```
http://myserver/cgi-bin/camctrl/eCamCtrl.cgi?channel=0&stream=0&move=right
http://myserver/cgi-bin/camctrl/eCamCtrl.cgi?channel=0&stream=1&vx=2&vy=2&vz=2
http://myserver/cgi-bin/camctrl/eCamCtrl.cgi?channel=0&stream=1&x=100&y=100&
videosize=640x480&resolution=640x480&stretch=0
```

PARAMETER	VALUE	DESCRIPTION
channel	<0~(n-1)>	Channel of video source.
stream	<0~(m-1)>	Stream.
move	home	Move to home ROI.
	up	Move up.
	down	Move down.
	left	Move left.
	right	Move right.
auto	pan	Auto pan.
	patrol	Auto patrol.
	stop	Stop auto pan/patrol.

zoom	wide	Zoom larger view with current speed.
	tele	Zoom further with current speed.
zooming	wide or tele	Zoom without stopping for larger view or further view with zs speed, used for joystick control.
zs	0 ~ 6	Set the speed of zooming, "0" means stop.
vx	<integer>	The direction of movement, used for joystick control.
vy	<integer>	
vs	0 ~ 7	Set the speed of movement, "0" means stop.
x	<integer>	x-coordinate clicked by user. It will be the x-coordinate of center after movement.
y	<integer>	y-coordinate clicked by user. It will be the y-coordinate of center after movement.
videosize	<window size>	The size of plug-in (ActiveX) window in web page
resolution	<window size>	The resolution of streaming.
stretch	<boolean>	0 indicates that it uses <b>resolution</b> (streaming size) as the range of the coordinate system. 1 indicates that it uses <b>videosize</b> (plug-in size) as the range of the coordinate system.
speedpan	-5 ~ 5	Set the pan speed.
speedtilt	-5 ~ 5	Set the tilt speed.
speedzoom	-5 ~ 5	Set the zoom speed.
speedapp	1 ~ 5	Set the auto pan/patrol speed.
return	<return page>	Redirect to the page <return page> after the parameter is assigned. The <return page> can be a full URL path or relative path according to the current path.

## 8.7 ePTZ Recall

**Note:** This request requires camctrl privileges.

Method: GET/POST

Syntax:

```
http://<servername>/cgi-bin/camctrl/eRecall.cgi?channel=<value>&stream=<value>&recall=<value>[&return=<return page>]
```

PARAMETER	VALUE	DESCRIPTION
channel	<0~(n-1)>	Channel of the video source.
stream	<0~(m-1)>	Stream.
recall	Text string less than 40 characters	One of the present positions to recall.
return	<return page>	Redirect to the page <return page> after the parameter is assigned. The <return page> can be a full URL path or relative path according to the current path.

## 8.8 ePTZ Preset Locations

**Note:** This request requires Operator privileges.

**Method:** GET/POST

Syntax:

```
http://<servername>/cgi-bin/operator/ePreset.cgi?channel=<value>&stream=<value>[&addpos=<value>][&delpos=<value>][&return=<return page>]
```

PARAMETER	VALUE	DESCRIPTION
channel	<0~(n-1)>	Channel of the video source.
stream	<0~(m-1)>	Stream.
addpos	<Text string less than 40 characters>	Add one preset location to the preset list.
delpos	<Text string less than 40 characters>	Delete preset location from the preset list.
return	<return page>	Redirect to the page <return page> after the parameter is assigned. The <return page> can be a full URL path or

	relative path according to the current path.
--	--

## 8.9 IP Filtering

**Note:** This request requires Administrator access privileges.

**Method:** GET/POST

Syntax:

```
http://<servername>/cgi-bin/admin/ipfilter.cgi?
method=<value>&[start=<ipaddress>&end=<ipaddress>][&index=<value>]
[&return=<return page>]
```

PARAMETER	VALUE	DESCRIPTION
method	addallow	Add allowed IP address range to the server. Start and end parameters must be specified. If the index parameter is specified, it will try to add starting from the index position.
	adddeny	Add denied IP address range to the server. Start and end parameters must be specified. If the index parameter is specified, it will try to add starting from the index position.
	deleteallow	Remove allowed IP address range from server. If start and end parameters are specified, it will try to remove the matched IP address. If index is specified, it will try to remove the address from given index position. [start, end] parameters have higher priority then the [index] parameter.
	deletedeny	Remove denied IP address range from server. If start and end parameters are specified, it will try to remove the matched IP address. If index is specified, it will try to remove the address from given index position. [start, end] parameters have higher priority then the [index] parameter.
start	<ip address>	The starting IP address to add or to delete.
end	<ip address>	The ending IP address to add or to delete.
index	<value>	The start position to add or to delete.
return	<return page>	Redirect to the page <return page> after the parameter is assigned. The <return page> can be a full URL path or relative path according to the current path. If you omit this parameter, it will redirect to an empty page.

## 8.9.1 IP Filtering for ONVIF

Syntax: **<product dependent>**

`http://<servername>/cgi-bin/admin/ipfilter.cgi?type[=<value>]`

`http://<servername>/cgi-bin/admin/ipfilter.cgi?method=add<v4/v6>&ip=<ipaddress>[&index=<value>][&return=<return page>]`

`http://<servername>/cgi-bin/admin/ipfilter.cgi?method=del<v4/v6>&index=<value>[&return=<return page>]`

PARAMETER	VALUE	DESCRIPTION
type	NULL	Get IP filter type
	allow, deny	Set IP filter type
method	addv4	Add IPv4 address into access list.
	addv6	Add IPv6 address into access list.
	delv4	Delete IPv4 address from access list.
	delv6	Delete IPv6 address from access list.
ip	<IP address>	Single address: <IP address> Network address: <IP address / network mask> Range address: <start IP address - end IP address>
index	<value>	The start position to add or to delete.
return	<return page>	Redirect to the page <return page> after the parameter is assigned. The <return page> can be a full URL path or relative path according to the current path. If you omit this parameter, it will redirect to an empty page.

## 8.10 Event/Control HTTP Tunnel Channel

**Note:** This request requires **Administrator** privileges.

**Method:** GET and POST

Syntax:

```
http://<servername>/cgi-bin/admin/ctrl event.cgi
```

---

```
GET /cgi-bin/admin/ctrl event.cgi
```

```
x-sessioncookie: string[22]
```

```
accept: application/x-vvtk-tunnelled
```

```
pragma: no-cache
```

```
cache-control: no-cache
```

---

```
POST /cgi-bin/admin/ ctrl event.cgi
```

```
x-sessioncookie: string[22]
```

```
content-type: application/x-vvtk-tunnelled
```

```
pragma : no-cache
```

```
cache-control : no-cache
```

```
content-length: 32767
```

```
expires: Sun, 9 Jan 1972 00:00:00 GMT
```

User must use GET and POST to establish two channels for downstream and upstream. The x-sessioncookie in GET and POST should be the same to be recognized as a pair for one session. The contents of upstream should be base64 encoded to be able to pass through the proxy server.

This channel will help perform real-time event subscription and notification as well as camera control more efficiently. The event and control formats are described in another document.

See Event/control tunnel spec for detail information

## 8.11 Get SDP of Streams

**Note:** This request requires Viewer access privileges.

**Method:** GET

Syntax:

```
http://<servername>/<network_rtsp_s<0~m-1>_accessname>
```

“m” is the stream number.

“network\_accessname\_<0~(m-1)>” is the accessname for stream “1” to stream “m”. Please refer to the “subgroup of network: rtsp” for setting the accessname of SDP.

You can get the SDP by HTTP GET.

When using scalable multicast, Get SDP file which contains the multicast information via HTTP.

## 8.12 Open the Network Stream

**Note:** This request requires Viewer access privileges.

Syntax:

For HTTP push server (MJPEG):

```
http://<servername>/<network_http_s<0~m-1>_accessname>
```

For RTSP (MP4), the user needs to input the URL below into an RTSP compatible player.

```
rtsp://<servername>/<network_rtsp_s<0~m-1>_accessname>
```

“m” is the stream number.

For details on streaming protocol, please refer to the “control signaling” and “data format” documents.

## 8.13 Storage managements

**Note:** This request requires **administrator** privileges.

**Method:** GET and POST

Syntax:

```
http://<servername>/cgi-bin/admin/lscrtl.cgi?cmd=<cmd_type>[&<parameter>=<value>...]
```

The commands usage and their input arguments are as follows.



PARAMETER	VALUE	DESCRIPTION
cmd_type	<string>	Required. Command to be executed, including <i>search</i> , <i>insert</i> , <i>delete</i> , <i>update</i> , and <i>queryStatus</i> .

**Command: search**

PARAMETER	VALUE	DESCRIPTION
label	<integer primary key>	Optional. The integer primary key column will automatically be assigned a unique integer.
triggerType	<text>	Optional. Indicate the event trigger type. Please embrace your input value with single quotes. Ex. mediaType='motion' Support trigger types are product dependent.
mediaType	<text>	Optional. Indicate the file media type. Please embrace your input value with single quotes. Ex. mediaType='videoclip' Support trigger types are product dependent.
destPath	<text>	Optional. Indicate the file location in camera. Please embrace your input value with single quotes. Ex. destPath ='/mnt/auto/CF/NCMF/abc.mp4'
resolution	<text>	Optional. Indicate the media file resolution. Please embrace your input value with single quotes. Ex. resolution='800x600'
isLocked	<boolean>	Optional. Indicate if the file is locked or not. 0: file is not locked. 1: file is locked. A locked file would not be removed from UI or cyclic storage.
triggerTime	<text>	Optional. Indicate the event trigger time. (not the file created time) Format is "YYYY-MM-DD HH:MM:SS" Please embrace your input value with single quotes. Ex. triggerTime='2008-01-01 00:00:00'

		If you want to search for a time period, please apply “TO” operation. Ex. <code>triggerTime='2008-01-01 00:00:00'+TO+'2008-01-01 23:59:59'</code> is to search for records from the start of Jan 1 <sup>st</sup> 2008 to the end of Jan 1 <sup>st</sup> 2008.
limit	<positive integer>	Optional. Limit the maximum number of returned search records.
offset	<positive integer>	Optional. Specifies how many rows to skip at the beginning of the matched records. Note that the offset keyword is used after limit keyword.

To increase the flexibility of search command, you may use “OR” connectors for logical “OR” search operations. Moreover, to search for a specific time period, you can use “TO” connector.

Ex. To search records triggered by motion or di or sequential and also triggered between 2008-01-01 00:00:00 and 2008-01-01 23:59:59.

```
http://<servername>/cgi-bin/admin/lscrtl.cgi?cmd=search&triggerType='motion'+OR+'di'+OR+'seq'
&triggerTime='2008-01-01 00:00:00'+TO+'2008-01-01 23:59:59'
```

**Command: delete**

PARAMETER	VALUE	DESCRIPTION
label	<integer primary key>	Required. Identify the designated record. Ex. <code>label=1</code>

Ex. Delete records whose key numbers are 1, 4, and 8.

```
http://<servername>/cgi-bin/admin/lscrtl.cgi?cmd=delete&label=1&label=4&label=8
```

**Command: update**

PARAMETER	VALUE	DESCRIPTION
label	<integer primary key>	Required. Identify the designated record. Ex. <code>label=1</code>
isLocked	<boolean>	Required. Indicate if the file is locked or not.

Ex. Update records whose key numbers are 1 and 5 to be locked status.

```
http://<servername>/cgi-bin/admin/lscrtl.cgi?cmd=update&isLocked=1&label=1&label=5
```

Ex. Update records whose key numbers are 2 and 3 to be unlocked status.

```
http://<servername>/cgi-bin/admin/lscrtl.cgi?cmd=update&isLocked=0&label=2&label=3
```

### 8.13.1 Return Message

The returned results are always in XML format, except for storage status related elements that can be returned in javascript format. (i.e. status, totalSize, freeSize, and usedSize.)

The elements are listed as follows.

Group: **stormgr**

Element name	Type	Description	
counts	<Positive Integer>	Total number of matched records.	
limit	<Positive Integer>	Limit the maximum number of returned search records. Could be empty if not specified.	
offset	<Positive Integer>	Specifies how many rows to skip at the beginning of the matched records. Could be empty if not specified.	
statusCode	<Integer>	The reply status (see table below)	
		Value of return-code	Description
		200	OK
		400	Unrecognized Message Type/Content
		500	Server executes command error.
		501	Parse Input Message Failed.
		502	Error Occurs When Searching Database.
503	Storage is Not Ready.		
statusString	string	Return string describing the reason that status code is not OK.	

Subgroup of **stormgr**: **i<0~(n-1)>**: n is the total number of displayed records.

Element name	Type	Description
label	<Integer Primary Key>	A unique integer.
triggerType	<Text>	Indicate the event trigger type.
mediaType	<Text>	Indicate the file media type.
destPath	<Text>	Indicate the file location in camera.
resolution	<Text>	Indicate the media file resolution.
isLocked	<Boolean>	Indicate if the file is locked or not.
triggerTime	<Text>	Indicate the event trigger time. Format is “YYYY-MM-DD HH:MM:SS”

backup	<Boolean>	Indicate if the file is generated when network loss.
--------	-----------	--

Subgroup of **stormgr\_disk: i<0~(n-1)>**: n is the total number of storage devices.

Element name	Type	Description
name	string	Description of specified storage device.
status	ready, detached, error, and readonly	The storage device status. ready: storage is ready for access. detached: storage is not mounted. error: failed to open storage device. readonly: storage is write protected.
totalSize	<Positive Integer>	The overall storage size in kilobytes.
freeSize	<Positive Integer>	The available storage size in kilobytes.
usedSize	<Positive Integer>	The used storage size in kilobytes.
path	string	Location of database of storage sink

Ex. Returned results of search command

```
<?xml version="1.0" encoding="ISO-8859-1" ?>
<stormgr version="0.0.0.1">
  <counts>5</counts>
  <limit>2</limit>
  <offset>0</offset >
  <i0>
    <label>1</label>
    <triggerType>motion</triggerType>
    <mediaType>videoclip</mediaType>
    <destPath>/mnt/auto/NCMF/abc/abc.jpg</destPath>
    <resolution>800x600</resolution>
    <isLocked>0</isLocked>
    <triggerTime>2009-01-24 12:00:00</triggerTime>
    <backup>0</backup>
  </i0>
  <i1>
    <label>2</label>
    <triggerType>di</triggerType>
    <mediaType>snapshot</mediaType>
    <destPath>/mnt/auto/NCMF/123/123.jpg</destPath>
    <resolution>800x600</resolution>
    <isLocked>0</isLocked>
    <triggerTime>2009-01-24 12:01:00</triggerTime>
  </i1>
</stormgr>

```

```

        <backup>0</backup>
    </i1>
</stormgr>
    
```

Ex. Local storage status in XML format.

```

<?xml version="1.0" encoding="ISO-8859-1" ?>
<stormgr version="0.0.0.1">
  <disk>
    <i0>
      <name>SDcard</name>
      <status>ready</status>
      <totalSize>7824444</totalSize>
      <freeSize>7824388</freeSize>
      <usedSize>56</usedSize>
    </i0>
  </disk>
</stormgr>
    
```

Ex. Local storage status in javascript format.

```

disk_i0_name='SDcard'
disk_i0_status='ready'
disk_i0_totalSize='7824444'
disk_i0_freeSize='7824388'
disk_i0_usedSize='56'
disk_i0_path=i0/NCMF/.db/.localStorage.db
    
```

Command: queryStatus

PARAMETER	VALUE	DESCRIPTION
retType	xml or javascript	Optional. Ex. retype=javascript The default return message is in XML format.

Ex. Query local storage status and call for javascript format return message.

```

http://<servername>/cgi-bin/admin/lscrtl.cgi?cmd=queryStatus&retType=javascript
    
```

There are two cgi commands for download and composing jpegs to avi format.

For download single selected file, you can use “/cgi-bin/admin/**downloadMedias.cgi**”. Just assign the request file path to this cgi.

Syntax:

```
http://<servername>/cgi-bin/admin/downloadMedias.cgi?<File_Path>
```

The <File\_Path> is in querystatus return message.

Ex.

```
http://<servername>/cgi-bin/admin/downloadMedias.cgi?/mnt/auto/CF/NCMF/20090310/07/02.mp4
```

For creating an AVI file by giving a list of JPEG files, you can use “/cgi-bin/admin/jpegtoavi.cgi”.

Syntax:

```
http://<servername>/cgi-bin/admin/jpegtoavi.cgi?<resolution>=<width>x<height>&<fps>=<num>&<list>=<fileList>
```

PARAMETER	VALUE	DESCRIPTION
resolution	<width>x<height>	Resolution
fps	<positive integer>	Frame rate
list	<fileList>	The JPEG file list. The file path should be embraced by single quotation marks

Ex.

```
http:// <servername>/cgi-bin/admin/jpegtoavi.cgi?resolution=800x600&fps=1&list='/mnt/auto/CF/NCMF/video1650.jpg', '/mnt/auto/CF/NCMF/video1651.jpg', '/mnt/auto/CF/NCMF/video1652.jpg',
```

## 8.14 Virtual input

**Note:** Change virtual input (manual trigger) status.

**Method:** GET/POST

Syntax:

```
http://<servername>/cgi-bin/admin/setvi.cgi?vi0=<value>[&vi1=<value>][&vi2=<value>]
[&return=<return page>]
```

PARAMETER	VALUE	DESCRIPTION
vi<num>	state[(duration)nstate]  Where "state" is 0, 1. "0" means inactive or normal state while "1" means active or triggered state.  Where "nstate" is next state after duration.	Ex: vi0=1  Setting virtual input 0 to trigger state  Ex: vi0=0(200)1  Setting virtual input 0 to normal state, waiting 200 <b>milliseconds</b> , setting it to trigger state.  Note that when the virtual input is waiting for next state, it cannot accept new requests.
return	<return page>	Redirect to the page <return page> after the request is completely assigned. The <return page> can be a full URL path or relative path according the current path. If you omit this parameter, it will redirect to an empty page.

Return Code	Description
200	The request is successfully executed.
400	The request cannot be assigned, ex. incorrect parameters. Examples: 1. setvi.cgi?vi0=0(10000)1(15000)0(20000)1 No multiple duration. 2. setvi.cgi?vi3=0 VI index is out of range. 3. setvi.cgi?vi=1 No VI index is specified.

503	<p>The resource is unavailable, ex. Virtual input is waiting for next state.</p> <p>Examples:</p> <ol style="list-style-type: none"> <li>1. setvi.cgi?vi0=0(15000)1</li> <li>2. setvi.cgi?vi0=1</li> </ol> <p>Request 2 will not be accepted during the execution time(15 seconds).</p>
-----	---

## 8.15 Open Timeshift Stream (**timeshift\_enable=1,** **timeshift\_c<n>\_s<m>\_allow=1**)

**Note:** This request requires Viewer access privileges.

Syntax:

For HTTP push server (MJPEG):

```
http://<servername>/<network_http_s<m>_accessname>?maxsft=<value>[&tsmode=<value>&reftime=<value>&forcechk&minsft=<value>]
```

For RTSP (MP4 and H264), the user needs to input the URL below into an RTSP compatible player.

```
rtsp://<servername>/<network_rtsp_s<m>_accessname>?maxsft=<value>[&tsmode=<value>&reftime=<value>&forcechk&minsft=<value>]
```

“n” is the channel index.

“m” is the timeshift stream index.

For details on timeshift stream, please refer to the “TimeshiftCaching” documents.

PARAMETER	VALUE	DEFAULT	DESCRIPTION
maxsft	<positive integer>	0	Request cached stream at most how many seconds ago.
tsmode	normal, adaptive	normal	Streaming mode: normal => Full FPS all the time. adaptive => Default send only I-frame for MP4 and H.264, and send 1 FPS for MJPEG. If DI or motion window are triggered, the streaming is changed to send full FPS for 10 seconds. (*Note: this parameter also works on non-timeshift streams.)
reftime	mm:ss	The time camera receives the	Reference time for maxsft and minsft. (This provides more precise time control to eliminate the inaccuracy due to network latency.)



		request.	Ex: Request the streaming from 12:20 rtsp://10.0.0.1/live.sdp?maxsft=10&reftime=12:30
forcechk	N/A	N/A	Check if the requested stream enables timeshift, feature and if minsft is achievable. If false, return “415 Unsupported Media Type”.
minsft	<positive integer>	0	How many seconds of cached stream client can accept at least. (Used by forcechk)

Return Code	Description
400 Bad Request	Request is rejected because some parameter values are illegal.
415 Unsupported Media Type	Returned, if forcechk appears, when minsft is not achievable or the timeshift feature of the target stream is not enabled.

## 8.16 Open Anystream

**Note:** This request requires Viewer access privileges.

Syntax:

For HTTP push server (MJPEG):

```
http://<servername>/videoany.mjpg?codectype=mjpeg[&resolution=<value>&mjpeg_quant=<value>&mjpeg_qvalue=<value>&mjpeg_maxframe=<value>]
```

For RTSP (MPEG4), the user needs to input the URL below into an RTSP compatible player.

```
rtsp://<servername>/liveany.sdp?codectype=mpeg4[&resolution=<value>&mpeg4_intraframe=<value>&mpeg4_ratecontrolmode=<value>&mpeg4_quant=<value>&mpeg4_qvalue=<value>&mpeg4_bitrate=<value>&mpeg4_maxframe=<value>]
```

For RTSP (H264), the user needs to input the URL below into an RTSP compatible player.

```
rtsp://<servername>/liveany.sdp?codectype=h264[&resolution=<value>&h264_intraframe=<value>& h264_ratecontrolmode=<value>& h264_quant=<value>& h264_qvalue=<value>& h264_bitrate=<value>& h264_maxframe=<value>]
```

<product dependent>

PARAMETER	VALUE	DEFAULT	DESCRIPTION
codectype	mjpeg, mpeg4, h264 <product dependent>	N/A	Set codec type for Anystream.
solution	capability_videoin_resolution	<product dependent>	Video resolution in pixels.

mjpeg_quant	0, 1~5 99, 1~5 <product dependent>	3	Quality of JPEG video. 0,99 is the customized manual input setting. 1 = worst quality, 5 = best quality. <product dependent>
mjpeg_qvalue	10~200 2~97 <product dependent>	50 <product dependent>	Manual video quality level input. (This must be present if mjpeg_quant is equal to 0, 99) <product dependent>
mjpeg_maxframe	1~25, 26~30 (only for NTSC or 60Hz CMOS)	15	Set maximum frame rate in fps (for JPEG).
mpeg4_intraperiod	250, 500, 1000, 2000, 3000, 4000	1000	Intra frame period in milliseconds.
mpeg4_ratecontrolmode	cbr, vbr	vbr	cbr: constant bitrate vbr: fix quality
mpeg4_quant	0, 1~5 99, 1~5 <product dependent>	3	Quality of video when choosing vbr in “mpeg4_ratecontrolmode”. 0,99 is the customized manual input setting. 1 = worst quality, 5 = best quality. <product dependent>
mpeg4_qvalue	1~31 2~31 <product dependent>	7 <product dependent>	Manual video quality level input. (This must be present if mpeg4_quant is equal to 0, 99) <product dependent>
mpeg4_bitrate	1000~8000000 1000~4000000 <product dependent>	512000 <product dependent>	Set bit rate in bps when choosing cbr in “mpeg4_ratecontrolmode”.
mpeg4_maxframe	1~25, 26~30 (only for NTSC or 60Hz CMOS)	10 15 <product dependent>	Set maximum frame rate in fps (for MPEG-4).

h264_intraperiod	250, 500, 1000, 2000, 3000, 4000	1000	Intra frame period in milliseconds.
h264_ratecontrolmode	cbr, vbr	vbr	cbr: constant bitrate vbr: fix quality
h264_quant	0, 1~5 99, 1~5 <product dependent>	3	Quality of video when choosing vbr in “h264_ratecontrolmode”. 0,99 is the customized manual input setting. 1 = worst quality, 5 = best quality. <product dependent>
h264_qvalue	0~51 <product dependent>	30 <product dependent>	Manual video quality level input. (This must be present if h264_quant is equal to 0, 99) <product dependent>
h264_bitrate	1000~8000000 1000~4000000 <product dependent>	512000 <product dependent>	Set bit rate in bps when choosing cbr in “h264_ratecontrolmode”.
h264_maxframe	1~25, 26~30 (only for NTSC or 60Hz CMOS)	10 15 <product dependent>	Set maximum frame rate in fps (for H264).

## 8.17 Export Files

**Note:** This request requires Administrator privileges.

**Method:** GET

Syntax:

For daylight saving time configuration file:

```
http://<servername>/cgi-bin/admin/exportDst.cgi
```

For language file:

```
http://<servername>/cgi-bin/admin/export_language.cgi?currentlanguage=<value>
```

PARAMETER	VALUE	DESCRIPTION
currentlanguage	0~20	Available language lists. Please refer to: system_info_language_i0 ~ system_info_language_i19.

For setting backup file:

```
http://<servername>/cgi-bin/admin/export_backup.cgi?backup
```

## 8.18 Upload Files

**Note:** This request requires Administrator privileges.

**Method:** POST

Syntax:

For daylight saving time configuration file:

```
http://<servername>/cgi-bin/admin/upload_dst.cgi
```

Post data:

```
filename =<file name>\r\n  
\r\n  
<multipart encoded form data>
```

For language file:

```
http://<servername>/cgi-bin/admin/upload_lan.cgi
```

Post data:

```
filename =<file name>\r\n
\r\n
<multipart encoded form data>
```

For setting backup file:

```
http://<servername>/cgi-bin/admin/upload_backup.cgi
```

Post data:

```
filename =<file name>\r\n
\r\n
<multipart encoded form data>
```

Server will accept the file named <file name> to upload this one to camera.

## 8.19 Media on demand

Media on demand allows users to select and receive/watch/listen to metadata/video/audio contents on demand.

**Note:** This request requires Viewer access privileges.

Syntax:

```
rtsp://<servername>/mod.sdp? [&stime=<value>] [&etime=<value>] [&length =<value>] [&loctime
=<value>] [&file=<value>] [&tsmode=<value>]
```

PARAMETER	VALUE	DEFAULT	DESCRIPTION
stime	<YYYYMMDD_HHMMSS.MMM>	N/A	Start time.
etime	<YYYYMMDD_HHMMSS.MMM>	N/A	End time.
length	<positive integer>	N/A	The length of media of interest. The unit is second.
loctime	<boolean>	0	Specify if start/end time is local time format. 1 for local time, 0 for UTC+0
file	<string>	N/A	The media file to be played.
tsmode	<positive integer>	N/A	Timeshift mode, the unit is second.

Ex.

stime	etime	length	file	Description
V	V	X	X	Play recordings between stime and etime rtsp://10.10.1.2/mod.sdp?stime=20110312_040400.000&etim



				e=2011_0312_040510.000
V	X	V	X	Play recordings for length seconds which start from stime rtsp://10.10.1.2/mod.sdp?stime=20110312_040400.000&length=120
X	V	V	X	Play recordings for length seconds which ends at etime rtsp://10.10.1.2/mod.sdp?etime=20110312_040400.000&length=120
X	X	X	V	Play file file rtsp://10.10.1.2/mod.sdp?filename=/mnt/link0/

<End of document>

---

i

VIVOTEK Confidential

# Technical Specifications

Technical Specifications	
<b>Models</b>	FD8137H-F3 FD8137H-F6
<b>System Information</b>	
CPU	Multimedia SoC (System-on-Chip)
Flash	128MB
RAM	256MB
<b>Camera Features</b>	
Image Sensor	1/3" Progressive CMOS
Maximum Resolution	1280x800 (1MP)
Lens Type	Fixed-focal
Focal Length	f = 3.6 mm (FD8137H-F3) f = 6 mm (FD8137H-F6)
Aperture	F = 1.8 (FD8137H-F3) F = 1.6 (FD8137H-F6)
Field of View	FD8137H-F3: 86° (Horizontal) 51° (Vertical) 103° (Diagonal) FD8137H-F6: 59° (Horizontal) 32° (Vertical) 70° (Diagonal)
Shutter Time	1/5 sec. to 1/32,000 sec.
WDR Technology	WDR Pro
Day/Night	Removable IR-cut filter for day & night function
Minimum Illumination	FD8137H-F3: 1.05 Lux @ F1.8, 50 IRE (Color) 0.001 Lux @ F1.8, 50 IRE (B/W) FD8137H-F6: 0.48 Lux @ F1.6, 50 IRE (Color) 0.001 Lux @ F1.6, 50 IRE (B/W)
Pan Range	350°
Tilt Range	60°
Rotation Range	350°
Pan/tilt/zoom	ePTZ:
Functionalities	48x digital zoom (4x on IE plug-in, 12x built-in)
IR Illuminators	Built-in IR illuminators, effective up to 15 meters IR LED*8
On-board Storage	MicroSD/SDHC/SDXC card slot
<b>Video</b>	
Compression	H.264 & MPEG-4
Maximum Frame Rate	30 fps @ 1280x800 In both compression
Maximum Streams	2 simultaneous streams
S/N Ratio	Above 53 dB
Video Streaming	Adjustable resolution, quality and bitrate Configurable video cropping for bandwidth saving
Image Settings	Adjustable image size, quality and bitrate Time stamp, text overlay, flip & mirror Configurable brightness, contrast, saturation, sharpness, white balance, exposure control, gain, backlight compensation, privacy masks Scheduled profile settings, 3D Noise Reduction
<b>Audio</b>	
Audio Capability	Audio input
Compression	G.711 / G.726
Interface	Built-in microphone
Effective Range	5 meters
<b>Network</b>	
Users	Live viewing for up to 10 clients
Protocols	IPv4, IPv6, TCP/IP, HTTP, HTTPS, UPnP, RTSP/RTMP/RTCP, IGMP, SMTP, FTP, DHCP, NTP, DNS, DDNS, PPPoE, CoS, QoS, SNMP, 802.1X
Interface	10Base-T/100 BaseTX Ethernet (RJ-45)
ONVIF	Supported, specification available at www.onvif.org
<b>Intelligent Video</b>	
Video Motion Detection	Triple-window video motion detection
<b>Alarm and Event</b>	
Alarm Triggers	Video motion detection, manual trigger, digital input, periodical trigger, system boot, recording notification, camera tampering detection
Alarm Events	Event notification using digital output, HTTP, SMTP, FTP and NAS server File upload via HTTP, SMTP, FTP and NAS server
<b>General</b>	
Connectors	RJ-45 for Network/PoE connection Digital input*1
LED Indicator	System power and status indicator
Power Input	IEEE 802.3af PoE Class 2
Power Consumption	Max. 5.1W
Dimensions	Ø: 127 mm x 91 mm
Weight	Net: 440 g
Safety Certifications	CE, LVD, FCC Class B, VCCI, C-Tick
Operating Temperature	0°C ~ 50°C (32°F ~ 122°F)
Warranty	24 months
<b>System Requirements</b>	
Operating System	Microsoft Windows 7/Vista/XP/2000
Web Browser	Mozilla Firefox 7~10 (streaming only) Internet Explorer 7/8/9/10
Other Players	VLC: 1.1.11 or above QuickTime: 7 or above
<b>Included Accessories</b>	
CD	User's manual, quick installation guide, Installation Wizard 2, ST7501 32-channel recording software
Others	Quick installation guide, warranty card, alignment sticker, screw pack, software CD
<b>Dimensions</b>	

Compatible Accessories	
<b>Mounting Kits</b> <b>AM-211</b> L-shape wall mount	<b>PoE Kits</b> <b>POE-IJ-1748NDN</b> 802.3af Compliant PoE Injector

All specifications are subject to change without notice. Copyright © 2013 VIVOTEK INC. All rights reserved.

Distributed by:



**VIVOTEK INC.**  
 6F, No.192, Lien-Cheng Rd., Chung-Ho, New Taipei City, 235, Taiwan, R.O.C.  
 [T: +886-2-82455282 | F: +886-2-82455532 | E: sales@vivotek.com  
**VIVOTEK USA, INC.**  
 2050 Ringwood Avenue, San Jose, CA 95131  
 [T: 408-773-8686 | F: 408-773-8298 | E: salesusa@vivotek.com

Ver 1.0

## Technical Specifications

<b>Models</b>	FD8137HV-F3 FD8137HV-F6	<b>Network</b>	
<b>System Information</b>		<b>Users</b>	Live viewing for up to 10 clients
<b>CPU</b>	Multimedia SoC (System-on-Chip)	<b>Protocols</b>	IPv4, IPv6, TCP/IP, HTTP, HTTPS, UPnP, RTSP/RTP/RTCP, IGMP, SMTP, FTP, DHCP, NTP, DNS, DDNS, PPPoE, CoS, QoS, SNMP, 802.1X
<b>Flash</b>	128MB	<b>Interface</b>	10Base-T/100 BaseTX Ethernet (RJ-45)
<b>RAM</b>	256MB	<b>ONVIF</b>	Supported, specification available at www.onvif.org
<b>Camera Features</b>		<b>Intelligent Video</b>	
<b>Image Sensor</b>	1/3" Progressive CMOS	<b>Video Motion Detection</b>	Triple-window video motion detection
<b>Maximum Resolution</b>	1280x800 (1MP)	<b>Alarm and Event</b>	
<b>Lens Type</b>	Fixed-focal	<b>Alarm Triggers</b>	Video motion detection, manual trigger, digital input, periodical trigger, system boot, recording notification, camera tampering detection
<b>Focal Length</b>	f = 3.6 mm (FD8137HV-F3) f = 6 mm (FD8137HV-F6)	<b>Alarm Events</b>	Event notification using digital output, HTTP, SMTP, FTP and NAS server File upload via HTTP, SMTP, FTP and NAS server
<b>Aperture</b>	F = 1.8 (FD8137HV-F3) F = 1.6 (FD8137HV-F6)	<b>General</b>	
<b>Field of View</b>	FD8137HV-F3: 86° (Horizontal) 51° (Vertical) 103° (Diagonal) FD8137HV-F6: 59° (Horizontal) 32° (Vertical) 70° (Diagonal)	<b>Connectors</b>	RJ-45 for Network/PoE connection Digital input*1
<b>Shutter Time</b>	1/5 sec. to 1/32,000 sec.	<b>LED Indicator</b>	System power and status indicator
<b>WDR Technology</b>	WDR Pro	<b>Power Input</b>	IEEE 802.3af PoE Class 2
<b>Day/Night</b>	Removable IR-cut filter for day & night function	<b>Power Consumption</b>	Max. 5.1W
<b>Minimum Illumination</b>	FD8137HV-F3: 1.05 Lux @ F1.8, 50 IRE (Color) 0.001 Lux @ F1.8, 50 IRE (B/W) FD8137HV-F6: 0.48 Lux @ F1.6, 50 IRE (Color) 0.001 Lux @ F1.6, 50 IRE (B/W)	<b>Dimensions</b>	Ø: 152 mm x 94 mm
<b>Pan Range</b>	350°	<b>Weight</b>	Net: 666 g
<b>Tilt Range</b>	60°	<b>Casing</b>	Weather-proof IP66-rated housing Vandal-proof IK10-rated housing
<b>Rotation Range</b>	350°	<b>Safety Certifications</b>	CE, LVD, FCC Class A, VCCI, C-Tick
<b>Pan/tilt/zoom</b>	ePTZ:	<b>Operating Temperature</b>	Starting Temperature: -10°C ~ 50°C (14°F ~ 122°F) Working Temperature: -20°C ~ 50°C (-4°F ~ 122°F)
<b>Functionalities</b>	48x digital zoom (4x on IE plug-in, 12x built-in)	<b>Warranty</b>	24 months
<b>IR Illuminators</b>	Built-in IR illuminators, effective up to 15 meters IR LED*8	<b>System Requirements</b>	
<b>On-board Storage</b>	MicroSD/SDHC/SDXC card slot	<b>Operating System</b>	Microsoft Windows 7/Vista/XP/2000
<b>Video</b>		<b>Web Browser</b>	Mozilla Firefox 7~10 (streaming only) Internet Explorer 7/8/9/10
<b>Compression</b>	H.264 & MPEG-4	<b>Other Players</b>	VLC: 1.1.11 or above QuickTime: 7 or above
<b>Maximum Frame Rate</b>	30 fps @ 1280x800 In both compression	<b>Included Accessories</b>	
<b>Maximum Streams</b>	2 simultaneous streams	<b>CD</b>	User's manual, quick installation guide, Installation Wizard 2, ST7501 32-channel recording software
<b>S/N Ratio</b>	Above 53 dB	<b>Others</b>	Quick installation guide, warranty card, alignment sticker, screw pack, software CD
<b>Video Streaming</b>	Adjustable resolution, quality and bitrate Configurable video cropping for bandwidth saving		
<b>Image Settings</b>	Adjustable image size, quality and bit rate Time stamp, text overlay, flip & mirror Configurable brightness, contrast, saturation, sharpness, white balance, exposure control, gain, backlight compensation, privacy masks Scheduled profile settings, 3D Noise Reduction		
<b>Audio</b>			
<b>Audio Capability</b>	Audio input		
<b>Compression</b>	G.711 / G.726		
<b>Interface</b>	Built-in microphone		
<b>Effective Range</b>	5 meters		

## Dimensions

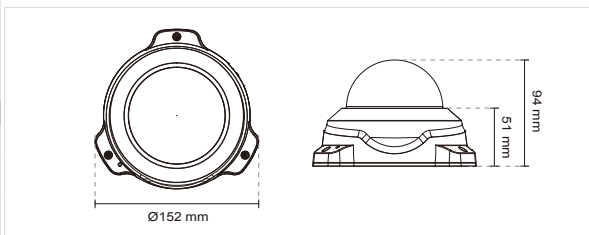

## Compatible Accessories

### Mounting Kits



**AM-211**  
L-shape wall mount

### PoE Kits



**POE-IJ-1748NDN**  
802.3af Compliant PoE Injector

All specifications are subject to change without notice. Copyright © 2013 VIVOTEK INC. All rights reserved.

Distributed by:



**VIVOTEK INC.**  
6F, No.192, Lien-Cheng Rd., Chung-Ho, New Taipei City, 235, Taiwan, R.O.C.  
| T: +886-2-82455282 | F: +886-2-82455532 | E: sales@vivotek.com

**VIVOTEK USA, INC.**  
2050 Ringwood Avenue, San Jose, CA 95131  
| T: 408-773-8686 | F: 408-773-8298 | E: salesusa@vivotek.com

Ver 1.0



## Technology License Notice

### AMR-NB Standard

THIS PRODUCT IS LICENSED UNDER THE AMR-NB STANDARD PATENT LICENSE AGREEMENT. WITH RESPECT TO THE USE OF THIS PRODUCT, THE FOLLOWING LICENSORS' PATENTS MAY APPLY:

TELEFONAKIEBOLAGET ERICSSON AB: US PAT. 6192335; 6275798; 6029125; 6424938; 6058359. NOKIA CORPORATION: US PAT. 5946651; 6199035. VOICEAGE CORPORATION: AT PAT. 0516621; BE PAT. 0516621; CA PAT. 2010830; CH PAT. 0516621; DE PAT. 0516621; DK PAT. 0516621; ES PAT. 0516621; FR PAT. 0516621; GB PAT. 0516621; GR PAT. 0516621; IT PAT. 0516621; LI PAT. 0516621; LU PAT. 0516621; NL PAT. 0516621; SE PAT. 0516621; US PAT. 5444816; AT PAT. 819303/AT E 198805T1; AU PAT. 697256; BE PAT. 819303; BR PAT. 9604838-7; CA PAT. 2216315; CH PAT. 819303; CN PAT. ZL96193827.7; DE PAT. 819303/DE69611607T2; DK PAT. 819303; ES PAT. 819303; EP PAT. 819303; FR PAT. 819303; GB PAT. 819303; IT PAT. 819303; JP PAT. APP. 8-529817; NL PAT. 819303; SE PAT. 819303; US PAT. 5664053. THE LIST MAY BE UPDATED FROM TIME TO TIME BY LICENSORS AND A CURRENT VERSION OF WHICH IS AVAILABLE ON LICENSOR'S WEBSITE AT [HTTP://WWW.VOICEAGE.COM](http://www.voiceage.com).

## Electromagnetic Compatibility (EMC)

### FCC Statement

This device complies with FCC Rules Part 15. Operation is subject to the following two conditions.

- This device may not cause harmful interference, and
- This device must accept any interference received, including interference that may cause undesired operation.

This equipment has been tested and found to comply with the limits for a Class B digital device, pursuant to Part 15 of the FCC Rules. These limits are designed to provide reasonable protection against harmful interference in a residential installation. This equipment generates, uses and can radiate radio frequency energy and, if not installed and used in accordance with the instructions, may cause harmful interference to radio communications. However, there is no guarantee that interference will not occur in a partial installation. If this equipment does cause harmful interference to radio or television reception, which can be determined by turning the equipment off and on, the user is encouraged to try to correct the interference by one or more of the following measures:

- Reorient or relocate the receiving antenna.
- Increase the separation between the equipment and receiver.
- Connect the equipment into an outlet on a circuit different from that to which the receiver is connected.
- Consult the dealer or an experienced radio/TV technician for help.

Shielded interface cables must be used in order to comply with emission limits.

### CE Mark Warning

This is a Class B product. In a domestic environment, this product may cause radio interference, in which case the user may be required to take adequate measures.

### VCCI Warning

この装置は、情報処理装置等電波障害自主規制協議会（VCCI）の基準に基づくクラスB情報技術装置です。この装置は、家庭環境で使用することを目的としていますが、この装置がラジオやテレビジョン受信機に近接して使用されると、受信障害を引き起こすことがあります。

取扱説明書に従って正しい取り扱いをして下さい

### Liability

VIVOTEK Inc. cannot be held responsible for any technical or typographical errors and reserves the right to make changes to the product and manuals without prior notice. VIVOTEK Inc. makes no warranty of any kind with regard to the material contained within this document, including, but not limited to, the implied warranties of merchantability and fitness for any particular purpose.