

CyberPower[®]

User's Manual

OLS1000ERT(XL)2U
OLS1500ERT(XL)2U
OLS2000ERT(XL)2U
OLS3000ERT(XL)2U

CyberPower Systems Inc.
www.cyberpower.com

K01-C000113-04

IMPORTANT SAFETY INSTRUCTIONS

This manual contains important instructions. Please read and follow all instructions carefully during installation and operation of the unit. Read this manual thoroughly before attempting to unpack, install, or operate the UPS.

CAUTION! The UPS must be connected to a grounded AC power outlet with fuse or circuit breaker protection. DO NOT plug the UPS into an outlet that is not grounded. If you need to power-drain this equipment, turn off and unplug the unit.

CAUTION! The battery can power hazardous components inside the unit, even when the AC input power is disconnected.

CAUTION! The UPS should be placed near the connected equipment and easily accessible.

CAUTION! To prevent the risk of fire or electric shock, install in a temperature and humidity controlled indoor area, free of conductive contaminants. (Please see specifications for acceptable temperature and humidity range).

CAUTION! (No User Serviceable Parts): Risk of electric shock, do not remove cover. No user serviceable parts inside. Refer servicing to qualified service personnel.

CAUTION! (Non-Isolated Battery Supply): Risk of electric shock, battery circuit is not isolated from AC power source; hazardous voltage may exist between battery terminals and ground. Test before touching.

CAUTION! To reduce the risk of fire, connect the UPS to a branch circuit with 10 amperes (OLS1000 / OLS1500) / 16 amperes (OLS2000/ OLS3000) maximum over-current protection in accordance to CE requirement.

CAUTION! The AC outlet where the UPS is connected should be close to the unit and easily accessible.

CAUTION! Please use only VDE-tested, CE-marked mains cable, (e.g. the mains cable of your equipment), to connect the UPS to the AC outlet.

CAUTION! Please use only VDE-tested, CE-marked power cables to connect any equipment to the UPS.

CAUTION! When installing the equipment, ensure that the sum of the leakage current of the UPS and the connected equipment does not exceed 3.5mA.

CAUTION! The OLS1000 / OLS1500 / OLS2000 / OLS3000 / Battery module models are only qualified maintenance personnel may carry out installations.

CAUTION! Do not unplug the unit from AC Power during operation, as this will invalidate the protective ground insulation.

CAUTION! To avoid electric shock, turn off and unplug the unit before installing the input/output power cord with a ground wire. Connect the ground wire prior to connecting the line wires!

CAUTION! Do not use an improper size power cord as it may

cause damage to your equipment and cause fire hazards.

CAUTION! Wiring must be done by qualified personnel.

CAUTION! DO NOT USE FOR MEDICAL OR LIFE SUPPORT EQUIPMENT! Under no circumstances this unit should be used for medical applications involving life support equipment and/or patient care.

CAUTION! DO NOT USE WITH OR NEAR AQUARIUMS! To reduce the risk of fire, do not use with or near aquariums. Condensation from the aquarium can come in contact with metal electrical contacts and cause the machine to short out.

CAUTION! Do not dispose of batteries in fire as the battery may explode.

CAUTION! Do not open or mutilate the battery, released electrolyte is harmful to the skin and eyes.

CAUTION! A battery can present a risk of electric shock and high short circuit current. The following precaution should be observed when working on batteries

1. Remove watches, rings or other metal objects.
2. Use tools with insulated handles.

CAUTION! The unit has a dangerous amount of voltage. When the UPS indicators is on, the units may continue to supply power thus the unit's outlets may have a dangerous amount of voltage even when it's not plugged in to the wall outlet.

CAUTION! Make sure everything is turned off and disconnected completely before conducting any maintenance, repairs or shipment.

CAUTION! Connect the Protection Earth (PE) safety conductor before any other cables are connected.

WARNING! (Fuses): To reduce the risk of fire, replace only with the same type and rating of fuse.

DO NOT INSTALL THE UPS WHERE IT WOULD BE EXPOSED TO DIRECT SUNLIGHT OR NEAR A STRONG HEAT SOURCE!

DO NOT BLOCK OFF VENTILATION OPENINGS AROUND THE HOUSING!

DO NOT CONNECT DOMESTIC APPLIANCES SUCH AS HAIR DRYERS TO UPS OUTPUT SOCKETS!

SERVICING OF BATTERIES SHOULD BE PERFORMED OR SUPERVISED BY PERSONNEL KNOWLEDGE OF BATTERIES AND THE REQUIRED PRECAUTIONS. KEEP UNAUTHORIZED PERSONNEL AWAY FROM BATTERIES!

HARDWARE INSTALLATION

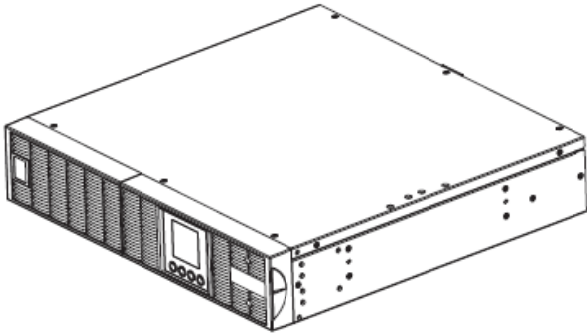

UPS



User's manual

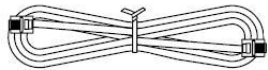

Phone line



USB communication cable



Input power cord

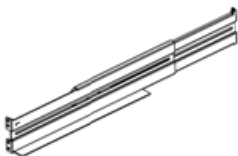

Rackmount left rail

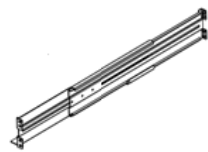

Rackmount right rail



Output power cords x2pcs



Flat head screws: M4X8L (8)



Pan head screws: M5X12L (12)



Plastic washers (8)



Screw hole dust covers (8)

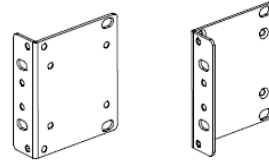

Rackmount ears (Stands) (2)

PowerPanel® Business Edition software is available on our website. Please visit www.cyberpower.com and go to the Software Section for free download.

HARDWARE INSTALLATION

HARDWARE INSTALLATION

These versatile UPS systems can be mounted in a rackmount or vertical tower orientation. This versatility is especially important to growing organizations with changing needs that value having the option to position a UPS on a floor or in a rackmount system. Please follow the instructions below for the respective mounting methods.

SAFETY PRECAUTIONS

CAUTION! To prevent the risk of fire or electric shock, only use the supplied hardware to attach the mounting brackets.

RACKMOUNT INSTALLATION

Step 1: Rackmount ears installation

Attach the two rackmount ears to the UPS using the provided screws M4X8L*8pcs.

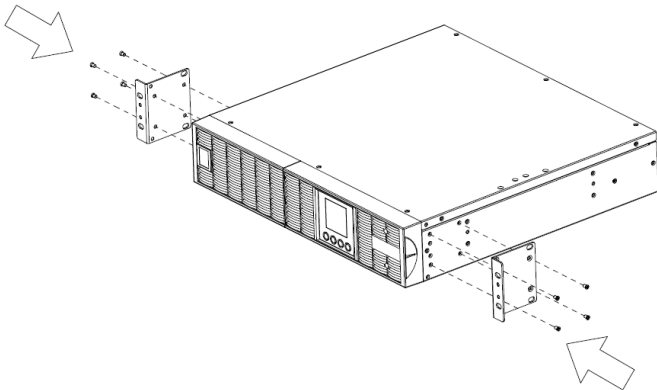

Step 2: Rackmount rails Installation

1) The rails adjust to mount in 48-cm (19-inch) panel racks from 52 to 91.5cm (20.5 to 36 inches) deep. Select the proper holes in the rack for positioning the UPS in the rack. The UPS takes up position 1 through position 6.

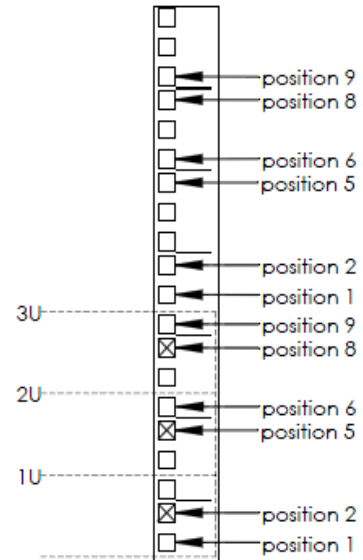

2) Attach the rackmount rail to your rack with two M5X12L screws and two plastic washers at the front of the rack. (Located in position 1 & position 6) Do not tighten the screws. Adjust the rail size on the rail assembly of your rack. Secure the rail to the rear of the rack with two M5X12L screws and two plastic washers. Tighten all screws at the front and rear of the rail. Once completed, perform the same steps for assembling the other rackmount rail.

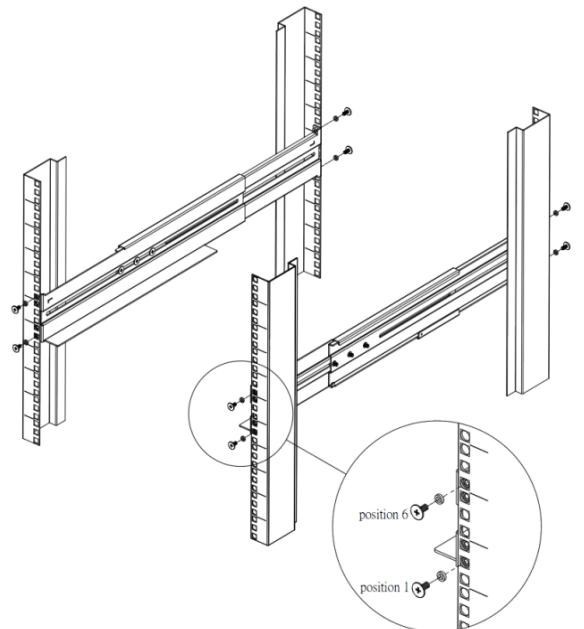

HARDWARE INSTALLATION

Step 3: Install the UPS on the rack

Place the UPS on a flat stable surface with the front of the unit facing toward you. Secure the UPS to your rack with four M5X12L screws at the front of the rack. (Located in position 2 & position 5).

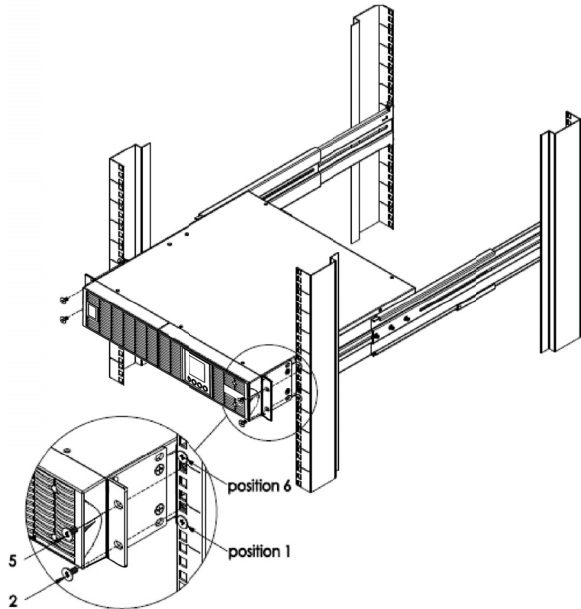

VERTICAL/TOWER INSTALLATION

Step 1: Rotate the Multifunction LCD Module

1) Unscrew the right panel of the UPS. Separate the right panel from the UPS.

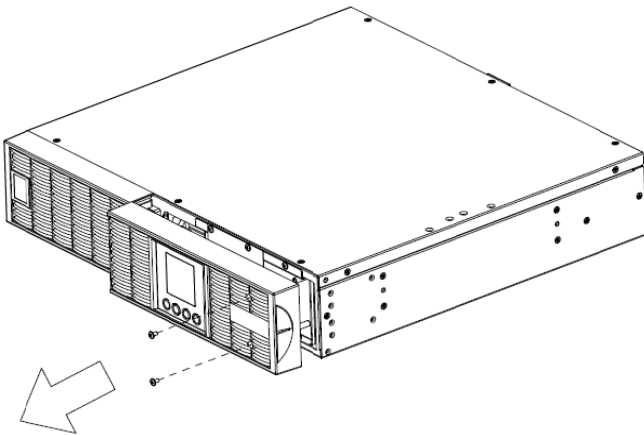

2) Unscrew the LCD plate, Gently lift the LCD module out. Rotate it to the tower orientation. Reinstall it for a tower configuration. Attach the LCD plate and LCD module to the right panel using the provided screws.

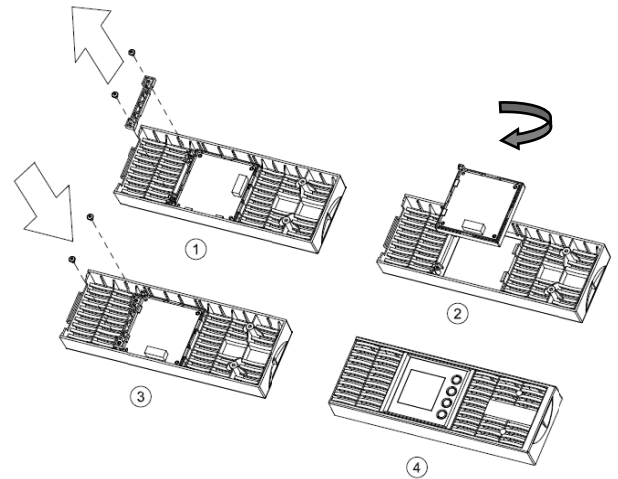

Step 2: Attach the base stands

Tighten the screws (M5X12*4pcs) of the base stands (rackmount ears) onto the bottom of the UPS.

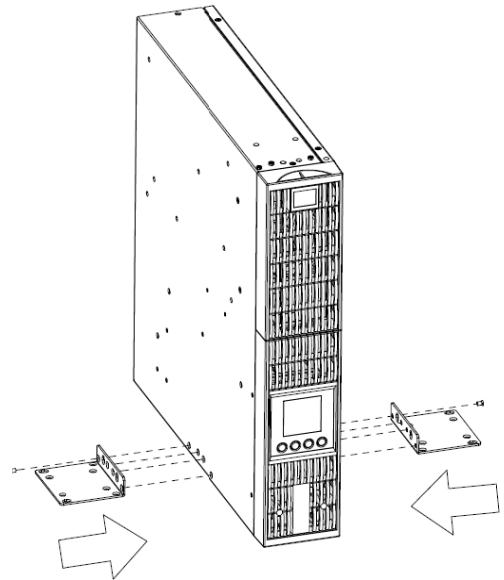

Step 3: Attach dust covers

Insert dust cover into the rackmount ear screw holes that are not being used.

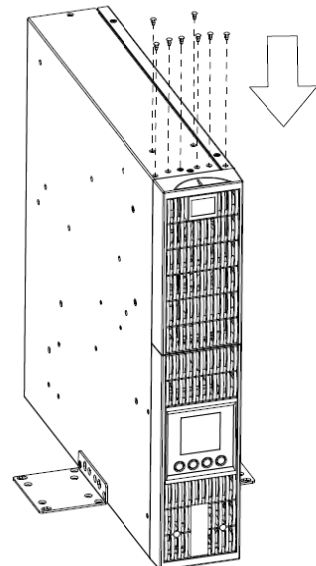

HARDWARE INSTALLATION

ELECTRICAL INSTALLATION

After completing the hardware installation of the UPS, you are now ready to plug in the UPS and connect your equipment.

SAFETY PRECAUTIONS

CAUTION! Installation environment should be in a temperature and humidity controlled indoor area free of conductive contaminants. Do not install this UPS where excessive moisture or heat is present (Please see specifications for acceptable temperature and humidity range).

CAUTION! Never install a UPS, or associated wiring or equipment, during a lightning storm.

CAUTION! Do not work alone under hazardous conditions.

CAUTION! In case of the risk of electric shock, do not remove the top cover.

CAUTION! The battery can energize hazardous live parts inside even when the AC input power is disconnected.

INSTALLING YOUR UPS SYSTEM

SYSTEM BLOCK DIAGRAM

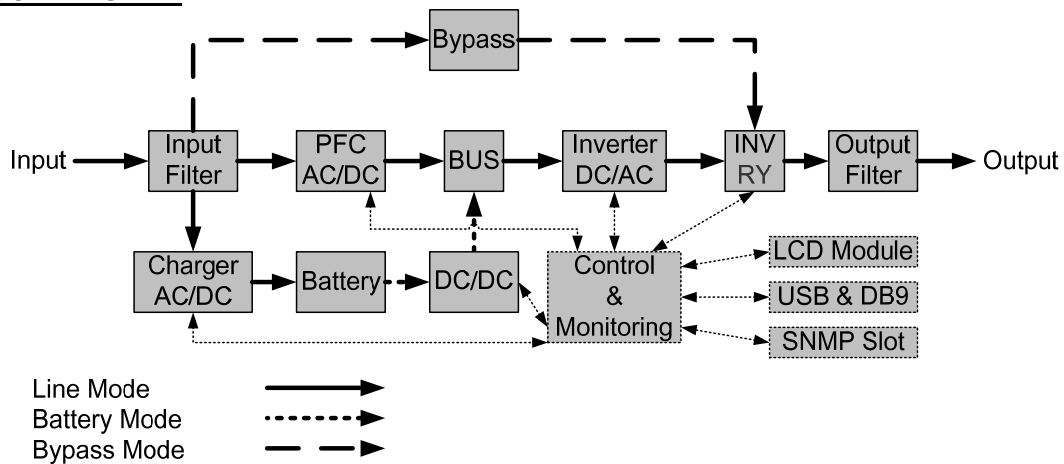

HARDWARE INSTALLATION GUIDE

1. Battery charge loss may occur during shipping and storage. Before using the UPS, it's strongly recommended to charge batteries for four hours to ensure the batteries' maximum charge capacity. To recharge the batteries, simply plug the UPS into an AC outlet.
2. When using the included software, connect either the serial or the USB cable between the computer and the corresponding port on the UPS. Note: If the USB port is used, the serial port will be disabled. They cannot be used simultaneously.
3. Connect your computer, monitor, and any externally-powered data storage device (Hard drive, Tape drive, etc.) into the outlets only when the UPS is off and unplugged. DO NOT plug a laser printer, copier, space heater, vacuum, paper shredder or other large electrical device into the UPS. The power demands of these devices will overload and possibly damage the unit.
4. To protect a fax machine, telephone, modem line or network cable, connect the telephone or network cable from the wall jack outlet to the jack marked "IN" on the UPS and connect a telephone cable or network cable from the jack marked "OUT" on the UPS to the modem, computer, telephone, fax machine, or network device.
5. Press the ON switch to turn the UPS on. If an overload is detected, an audible alarm will sound and the UPS will continuously emit one beep per second. For resetting the unit, unplug some equipment from the outlets. Make sure your equipment carries a load current within the unit's safe range, (refer to the technical specifications).
6. This UPS is equipped with an auto-charge feature. When the UPS is plugged into an AC outlet, the battery will automatically charge, even when the unit is switched off.

7. To maintain an optimal battery charge, leave the UPS plugged into an AC outlet at all times.

8. Before storing the UPS for an extended period of time, turn the unit OFF. Then cover it and store it with the batteries fully charged. Recharge the batteries every three months to ensure good battery capacity and long battery life. Maintaining a good battery charge will help prevent possible damage to the unit from battery leakage.

9. The UPS has one USB port (default) and one Serial port that allows connection and communication between the UPS and any attached computer running the PowerPanel® Business Edition Agent software. The UPS can control the computer's shutdown during a power outage through the connection while the computer can monitor the UPS and alter various programmable parameters. Note: Only one communication port can be used at a time. The port not in use will automatically become disabled or the serial port will be disabled if both ports are attached.

10. EPO (Emergency Power Off) / ROO (Remote on/off) Port: EPO/ROO ports allow administrators the capability to connect the UPS unit to customer-supplied EPO/ROO switches. If EPO is enabled, these installations give operators a single access point to immediately power-off all equipment connected to the UPS during an emergency. If ROO is enabled, these installations give operators a access point to turn on/off UPS remotely.

11. To avoid electric shock, turn the unit OFF and disconnect the unit from utility power before hardwiring the UPS (in/out power cord). The in/out power cord **MUST** be grounded.

BASIC OPERATION

POWER MODULE FRONT/REAR PANEL DESCRIPTION

1. Power On/Off Button

Master ON/OFF for the UPS.

2. Function Buttons

Scroll up, scroll down, select and cancel LCD menu.

3. Multifunction LCD Readout

Indicate status information, settings and events.

4. Input Circuit Breaker

Provide input overload and fault protection.

5. Battery Backup & Surge Protected Outlets

Provide battery backup and surge protection. They ensure power is provided to connected equipment over a period of time during a power failure.

6. Serial Port

Serial port provides communication between the UPS and the computer. The UPS can control the computer's shutdown during a power outage through the connection while the computer can monitor the UPS and alter its various programmable parameters.

7. USB port

This is a connectivity port which allows communication and control between the UPS and the connected computer. It is recommended to install the PowerPanel® Business Edition Agent software on the PC/Server connected with the USB cord.

8. Surge Protected Communication Ports RJ-45/RJ-11

These ports are used to protect standard RJ-45/RJ-11 based products (ADSL, LAN, Phone/ Modem-Lines) and cabling systems from surges.

9. SNMP/HTTP Network slot

Slot to install the optional SNMP card for remote network control and monitoring.

10. Extended Runtime Battery Module Connector

Connect to additional external battery modules.

11. EPO (Emergency Power Off) Connector

Enable Power-Off in emergency from a remote location.

12. AC Input Inlet

Connect the AC Power cord to a properly wired and grounded outlet.

13. Output Circuit Breaker

Provide overload and fault protection.

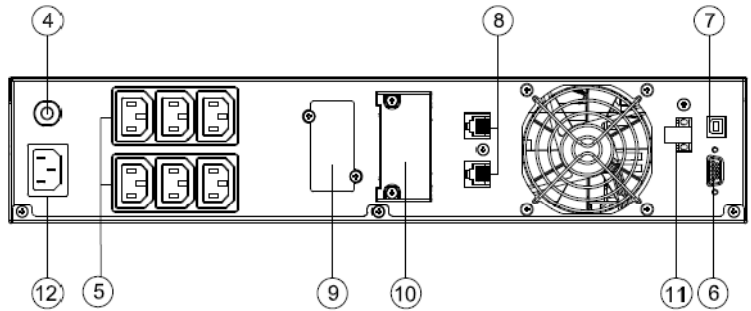
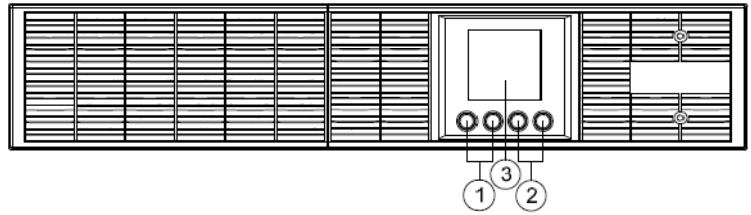

OLS1000ERT(XL)2U, OLS1500ERT(XL)2U

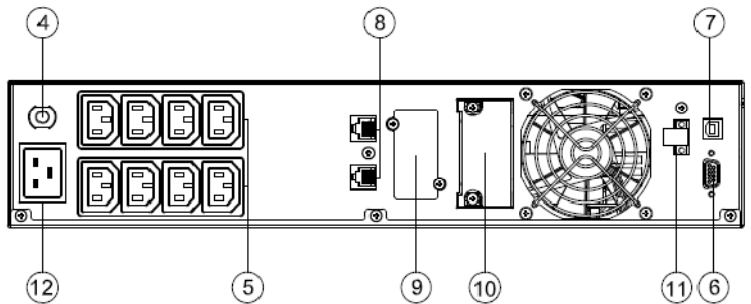
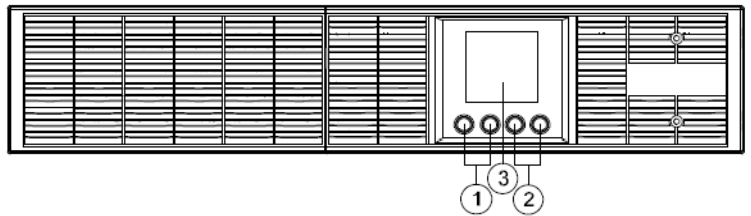

OLS2000ERT(XL)2U

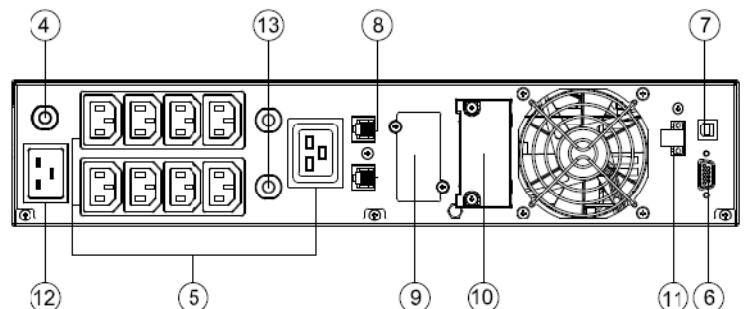
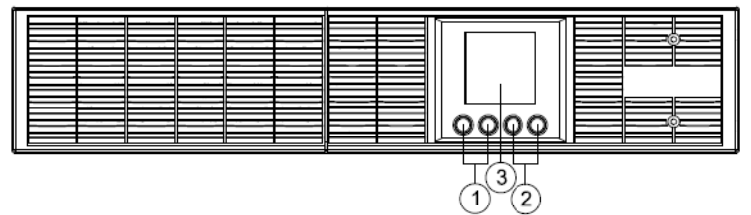

OLS3000ERT/ERT(XL)2U

BASIC OPERATION

BATTERY MODULE FRONT/REAR PANEL DESCRIPTION

1. Input Connector

Use this input connector to daisy chain the next Battery module.

Remove the connector cover for access.

2. On-board Replaceable Fuse Cover

Replaceable fuse is accessible from the rear panel.

It must be done by qualified personnel.

3. Output Connector

Use this output Connector to connect the Battery module to the Power module or to the next Battery module.

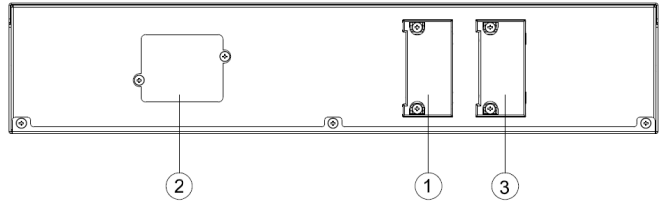

BPSE36V45ART2U, BPSE72V45ART2U

CONNECTION 1 : POWER MODULE WITH ONE BATTERY MODULE

Step 1: Loosen the two screws to remove the battery cable retention bracket of the power module.

Step 2: Use the battery cable of the Battery module to connect the Battery module to the Power module.

Step 3: Rotate the battery cable retention racket and tighten the two screws to fix battery cable.

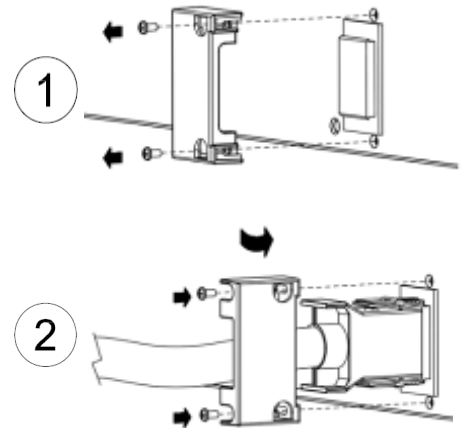
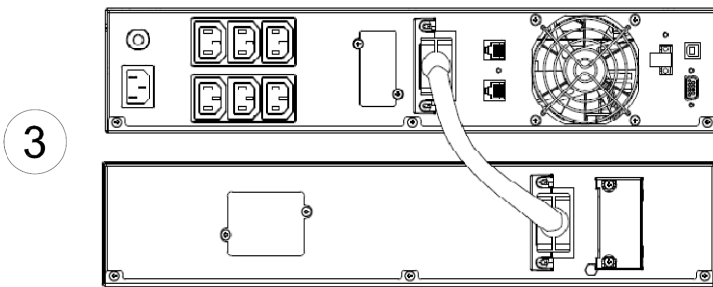

CONNECTION 2 : POWER MODULE WITH MULTIPLE BATTERY MODULES

Step 1: Connect the 1st Battery module to the Power module using battery cable.

Step 2: Loosen the two screws to remove the battery cable retention bracket of the 1st battery module.

Step 3: Use the battery cable to connect the 2nd Battery module to the 1st Battery module.



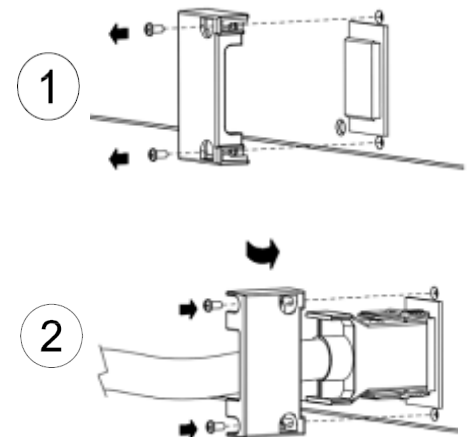
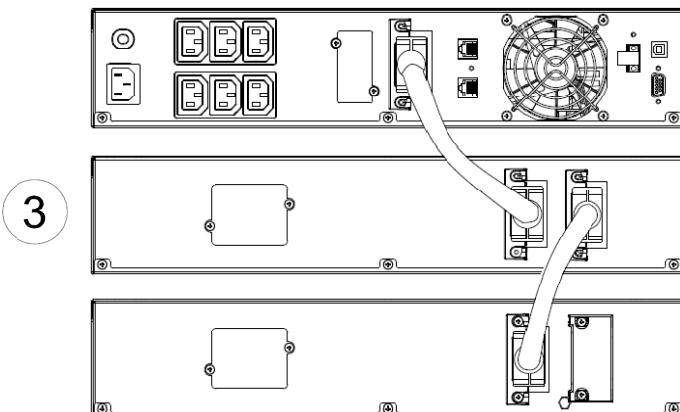

Step 4: Rotate the battery cable retention bracket and tighten the two screws to fix battery cable.

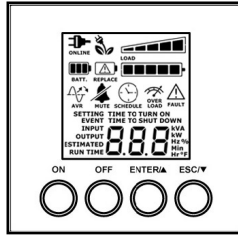

BASIC OPERATION



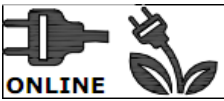



LCD SCREEN – UPS STATUS

LCD Screen	UPS Status Description
	UPS is operating in Line Mode.
	UPS is operating in Battery Mode.
	UPS is operating in Bypass Mode.
	UPS is operating in ECO (Economy) Mode.*
	UPS is operating in Converter Mode when this icon blinking**.

*) When operating in ECO Mode, the efficiency of UPS is higher than that in online mode, but transfer time should not be 0ms

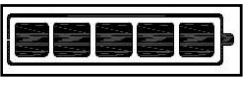
***) When operating in Converter Mode, the frequency of output should be always 50Hz or 60Hz, but load capacity will be derated.

DEFINITIONS FOR OTHER ICONS

LCD Screen	Description
	LOAD capacity: This meter displays the approximate output load level (in 20% increments) of the UPS outlets.
	BATTERY capacity: This meter displays the approximate charge level (in 20% increments) of the UPS's internal battery. During a blackout or severe brownout, the UPS switches to battery power, the BATTERY icon appears, and the charge level decreases.
	MUTE: This icon appears whenever the UPS is in silent mode. The alarm does not beep during silent mode until the battery reaches low capacity.
	SCHEDULE: Users can setup the schedule to turn on and shut down the computer and UPS through PowerPanel® Personal Edition software. The LCD display will show how much time is left before the UPS will turn back on or shut down.
	OVER LOAD: This icon appears and an alarm sounds to indicate the outlets are overloaded. To clear the overload, unplug some of your equipment from the battery-supplied outlets until the icon turns off and the alarm stops.
	FAULT: This icon appears if there is a problem with the UPS. Please refer to "Event ID Descriptions".

BASIC OPERATION



REPLACE: This icon appears if the batteries need to be replaced.

Event ID Descriptions

Event ID	Description of Cause
1	Bus Start Fail: DC-DC converter or bus sensing circuit failed.
2	Bus Volt High: DC-DC converter failed.
3	Bus Volt Low: DC-DC converter failed.
4	Bus Unbalanced: DC-DC converter failed.
5	INV Start Fail: Inverter circuit failed.
6	INV Volt High: Inverter circuit or output voltage sensing circuit failed.
7	INV Volt Low: The load may be too heavy or inverter circuit failed.
8	INV Short: The inverter circuit failed.
9	Bat Volt High: The external battery module connection is wrong, or the charger failed.
10	Bat Volt Low: Batteries failed.
11	Over Temperature: High ambient temperature, or the ventilation hole has been covered.
12	Over Load: UPS is overloaded.
54	High Temperature: High ambient temperature, or the ventilation hole has been covered. This is shown only when start up UPS.
55	Bat Low: Battery voltage is too low to DC start UPS.
57	EPO Off: Missing the EPO connection
58	Fan Fail: The ventilation hole has been covered, or the fans can't work.
59	Bat Bad: Battery failed.

BUTTON OPERATION

Button	Operation Description
ON	Press this button to turn on UPS.
OFF	Press this button to turn off UPS.*
ENTER/▲	Press this button to scroll up in the LCD menu. Press this button simultaneously for 5 seconds to disable or enable the alarm system while in battery mode. Press this button simultaneously for 5 seconds to enter UPS self-testing while in AC mode, ECO mode, or converter mode. In setting mode, press this button to confirm selection, or press this button for long time to exit setting mode and saving changes.
ESC/▼	Press this button to scroll down in the LCD menu. Press this button for long time to get into setting mode In setting mode, press this button to display next selection, or press this button for long time to exit setting mode without saving changes.
ENTER/▲ + ESC/▼	Switch to bypass mode: When the main power is normal, press these two buttons simultaneously for 5 seconds, then UPS will enter to bypass mode.

*) If utility power is connected, UPS will keep charging but cut off output.

LCD SETUP FUNCTIONS

LCD INFORMATION READOUT

There are 12 types of UPS information available for display on digit area.

Information Submenu	Description
OUTPUT XXX V	Displays the Output Voltage
OUTPUT XX.XHz	Displays the Output Frequency
OUTPUT XXX (k)VA	Displays the Output VA
OUTPUT XXX% VA	Displays the Output Load Percentage of Maximum Apparent Power
OUTPUT XXX (k)W	Displays the Output Wattage
OUTPUT XXX% W	Displays the Output Load Percentage of Maximum Active Power
INPUT XXX V	Displays the Input Voltage
EVENT XXX	Displays the Event ID
ESTIMATED RUN TIME %	Displays the Estimated Percentage of Battery Capacity
ESTIMATED RUN TIME XX(.)X [Min][Hr]	Displays the Estimated Run Time with battery
TIME TO SHUT DOWN XX(.)X [Min][Hr]	Displays the Time Delay to Shutdown UPS
TIME TO TURN ON XX(.)X [Min][Hr]	Displays the Time Delay to Restart UPS

LCD SETTINGS CONFIGURATION

There are 8 UPS settings that can be configured by the user.

1. Press the “**ESC**” button simultaneously for 5 seconds to activate the setting mode.
The first configuration parameter will be displayed on the LCD screen.

Note: The manual settings programming mode can ONLY be invoked while UPS is in Bypass mode or Standby mode. To make UPS on Standby mode or Bypass mode, connect utility power to UPS and do not turn on UPS.

2. Press the “**ENTER**” button to select the setting you want to configure.
3. Press the “**▼**” buttons to scroll through the different parameters.
Press the “**ENTER**” button to select the parameter you want.
4. Press the “**ESC**” button simultaneously for 5 seconds to cancel and exit setting mode. Press the “**ENTER**” button simultaneously for 5 seconds to save all the settings you just do and exit setting mode.

LCD SETUP FUNCTIONS

Configure Submenu	Available Settings	Default Setting
Output Voltage	= [208V] [220V] [230V] [240V]	230V
Output Frequency	= [50Hz][60Hz]	50Hz
ECO Mode *	[0%] (Disable) [10%][15%] (Enable)	0%
Bypass Mode **	[DIS] (Disable) [ENA] (Enable)	Enable
Converter Mode	[DIS] (Disable) [ENA] (Enable)	Disable
EPO/ROO***	[EPo] [Roo]	EPO
EBM Number****	[0] [1] [2] [3] [4] [5] [6] [7] [8] [9] [10](for -E models, the maximum number is 3)	0(for -E models) / 1 (for -EXL models)
Bypass when UPS is Off	[F1d](Disable)[F1E](Enable)	Disable

*) This function would be set as 0% when Converter Mode is enabled.

**) UPS has no bypass when Converter Mode is enabled.

*** ROO (Remote On/Off): If ROO is enabled, UPS can be turn on/off by the ROO port. If ROO port is disconnected, UPS will be turned off. If ROO port is connected, UPS will be turned on when the utility is normal

****) UPS cannot detect the numbers of external battery automatically, so manual input from user is necessary.

SILENCING AUDIBLE ALARMS

Press the “**ENTER**” button on simultaneously for 5 seconds to disable or enable the alarm system while in battery mode.

Note: Some audible alarms (Over Temperature, Fan Fail, etc.) can't be silenced.

MANUAL BATTERY TEST

Press the “**ENTER**” button simultaneously for 5 seconds to enter UPS self-testing while in AC mode, ECO mode, or converter mode.

MAINTENANCE

Storage

To store your UPS for an extended period, cover it and store with the battery fully charged. Recharge the battery every three months to ensure battery life.

Safety Precautions

CAUTION! Only use replacement batteries which are certified by CyberPower Systems. Use of incorrect battery type is an electrical hazard that could lead to explosion, fire, electric shock, or short circuit.

CAUTION! Batteries contain an electrical charge that can cause severe burns. Before servicing batteries, please remove any conductive materials such as jewelry, chains, wrist watches, and rings.

CAUTION! Do not open or mutilate the batteries. Electrolyte fluid is harmful to the skin/eyes and may be toxic.

Battery Installation and replacement

Step 1: Remove the front panel. Remove the retaining screws from the battery bracket and then remove the cover itself. undraw the connectors.

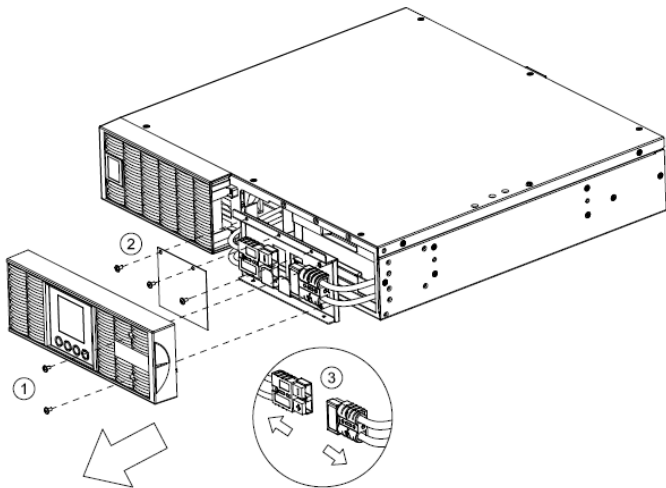

Step 2: Pull the battery tray out slowly. Put the new battery tray back into the compartment after that.

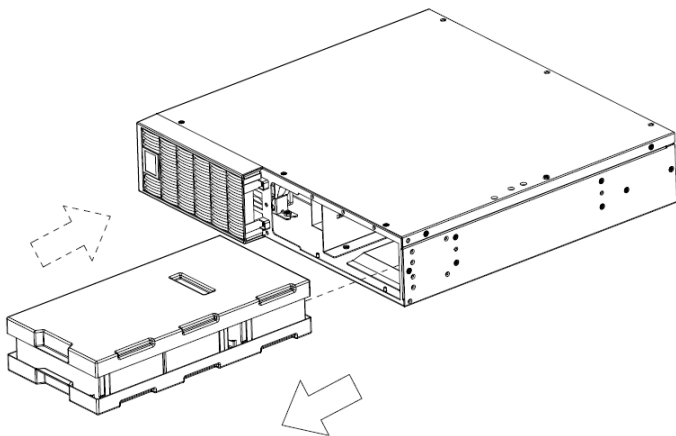

CAUTION! To avoid electric shock, turn off and unplug the UPS from the wall receptacle before servicing the battery.

CAUTION! Only use tools with insulated handles. Do not lay tools or metal parts on top of the UPS or battery terminals.

Replacement Batteries

Please refer to the front side of the UPS for the model number of the correct replacement batteries. For battery procurement, log onto www.cyberpower.com, or contact your local dealer.

Battery Disposal

Batteries are considered hazardous waste and must be disposed of properly. Contact your local government for more information about proper disposal and recycling of batteries. Do not dispose of batteries in fire.

Step 3: Fasten the battery bracket and then insert the connectors. Place the connectors in the bracket.

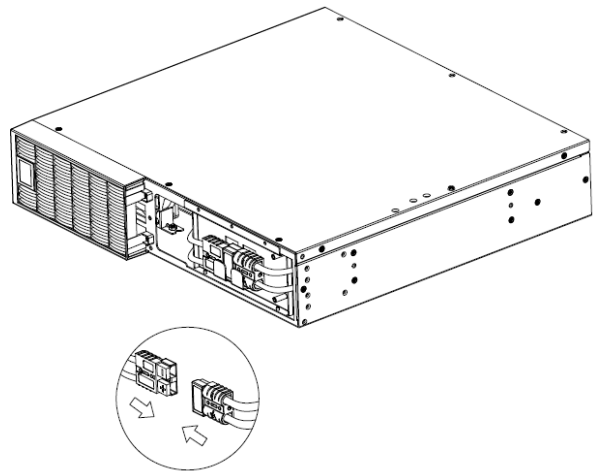

Step 4: Tighten the screws of the battery bracket and front panel .

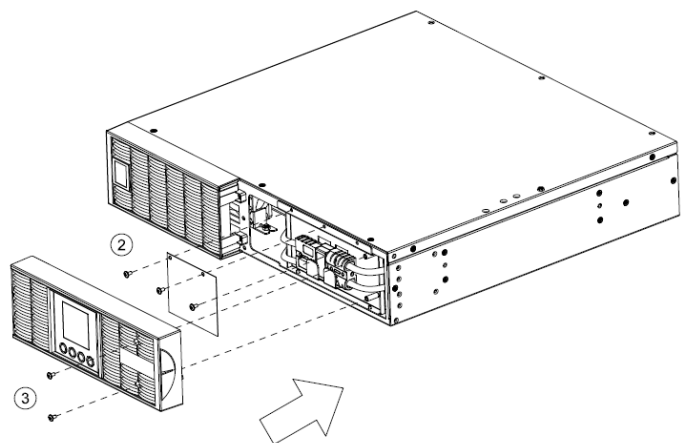

TECHNICAL SPECIFICATIONS

Model	OLS1000ERT (XL)2U	OLS1500ERT (XL)2U	OLS2000ERT (XL)2U	OLS3000ERT (XL)2U
Configuration				
Capacity (VA)	1000VA	1500VA	2000VA	3000VA
Capacity (Watts)	900W	1350W	1800W	2700W
Form Factor	Rack			
Energy-saving Technology	Yes, ECO Mode Efficiency \geq 95%			
Input				
Input Voltage Range	110~130Vac \pm 5% for 1000 / 1500 / 2000 VA model		@ 0~50% Load \pm 5%	
	110~140Vac \pm 5% for 3000 VA only			
	120~140Vac \pm 5% for 1000 / 1500 / 2000 VA model		@ 0~60% Load \pm 5%	
	140~160Vac \pm 5% for 3000 VA only			
140~160Vac \pm 5% for 1000 / 1500 / 2000 VA model		@ 0~80% Load \pm 5%		
160~190Vac \pm 5% for 3000 VA only				
160~300Vac \pm 5% for 1000 / 1500 / 2000 VA model		@ 0~100% Load \pm 5%		
190~300Vac \pm 5% for 3000 VA only				
Input Frequency Range	40~70Hz			
Input Power Factor	0.98			
Cold Start	Yes			
Output				
Output Waveform	Pure Sine Wave			
Output Voltage	208, 220, 230, 240Vac \pm 1%			
Output Frequency	50 / 60Hz (Auto-Sensing or Configurable) \pm 0. 5Hz			
Transfer Time (Typically)	0ms			
Rated Power Factor	0.9			
Harmonic Distortion	THD < 3% at Linear Load, < 5% at Non-linear Load @ Nominal Input			
Crest Factor	3 : 1			
ECO Mode Voltage Regulation	\pm 10%, \pm 15% (Configurable)			
UPS Outlets	(3+3) IEC C13	(4+4) IEC C13		(4+4) IEC C13 (1) IEC C19
Protection				
Surge Protection	IEC 61000-4-5 Level 4			
Phone / Network Protection	RJ11/RJ45 (One In/One Out)			
Overload Protection	Line Mode :		105~110% Overload warning only (No shutdown),	
			110~120% Warning, transfer to bypass after 60s	
			>120% Transfer to bypass immediately	
	Battery Mode :		105~110% Overload warning only (No shutdown),	
		110~120% Warning, shutdown after 10s		
		>120% Shutdown immediately		
Bypass Mode :		Warning only @ 130%>Load>105%, Shutdown immediately @		
		Load>130%		
Short Circuit Protection	UPS Output Cut off Immediately or Input Fuse / Circuit Breaker Protection			
Battery				
Specifications	(3) 12V/7AH	(3) 12V/9AH	(6) 12V/7AH	(6) 12V/9AH
	For XL Models, NO Battery Inside.			
Recharge Time (Typically)	4 Hours (inside batteries)			
Sealed, Maintenance Free	Yes			
Status Indicators				
LCD Screen	Graphic LCD			
Audible Alarms	Battery Mode, Battery Low, Overload, UPS Fault, Replace Battery, Bypass Mode Charger Failure /Over Charged, Fan failure, EPO active			
Environment				
Operating Temperature	32°F to 104°F (0°C to 40°C)			
Operating Relative Humidity	20 to 90% Non-Condensing			

TECHNICAL SPECIFICATIONS

Management				
On-Device Features	Self Test, Auto-Charge, Auto-Restart, Auto-Overload Recovery			
Connectivity Ports	(1) Serial Port (RS232), (1) USB Port,			
SNMP/HTTP Capable	(1) Expansion Port (With optional RMCARD 205)			
Software				
Power Management Software	PowerPanel® Business Edition			
Physical				
Dimensions (H x W x D)	3.46x 17.24x16.93 in. 88×438×430 mm		3.46x 17.24x24.02 in. 88×438×610 mm	
Net Weight	384.2(18.6)lbs 13.2(8.4)Kg	32.2(18.8)lbs 14.6(8.5)Kg	46.8(25.6)lbs 21.2(11.6)Kg	60.9(26.5)lbs 27.6(12)Kg
Safety				
Conformance Approvals	CE			

*) Within 50/60Hz±8% by default, the output frequency is synchronization with input mains. User can adjust the acceptable range for output frequency (±1, 2, 3, 4, 5, 6, 7, 8, 9, 10%). When input frequency is out of synchronization window but within 40-70Hz, UPS can stay in line mode and output frequency is regulated at 50/60Hz+0.5% with load derating by 40%.

TROUBLE SHOOTING

Problem	Possible Cause	Solution
Warning		
O/P Overload	Your equipment requires more power than the UPS can provide. If the UPS is in Line Mode then it will transfer to Bypass Mode; if the UPS is in Battery Mode it will shutdown.	Shut off non-essential equipment. If this solves the overload problem, the UPS will transfer to normal operation.
Battery Mode	UPS is operating on battery power.	Save your data and perform a controlled-shutdown.
Battery Low	UPS is operating on battery power and will be shutting down soon due to extremely low battery voltage.	UPS will restart automatically when acceptable utility power returns.
BAT Disconnected/ Battery Replace	Missing battery power.	Check battery connector when use battery packages.
	UPS has failed in Battery Test.	Contact technical support to replace the battery.
Charger Failure	Charger has failed.	<ol style="list-style-type: none"> 1. Shut down UPS and turn off AC input. 2. Contact CyberPower for repair.
EPO OFF	Missing the EPO connection.	Check the EPO connection.
Fault		
Over Temperature	High ambient temperature.	<ol style="list-style-type: none"> 1. Shut down UPS. Restart UPS to Check the fan for operation and if the ventilation hole has been covered 2. Contact CyberPower for repair.
Output Short	Output short circuit.	<ol style="list-style-type: none"> 1. Shut down UPS 2. Your attached equipment may have problems, please remove them and check again.
High O/P V	Output voltage is too high.	<ol style="list-style-type: none"> 1. Shut down UPS 2. Contact CyberPower for repair.
Low O/P V	Output voltage is too low.	
Bus Fault	Internal DC bus voltage is too high or too low.	
Other		
Startup fail	High temperature, or fan fail, or battery low, or EPO off..	<ol style="list-style-type: none"> 1. Restart UPS and press the “▼” button to view the warning event. Then refer to the solution for the warning. 2. Contact CyberPower for repair.

TROUBLE SHOOTING

CyberPower Systems Inc.

www.cyberpower.com

6F, No. 32, Sec. 1, Chengong Rd., Nangang District, Taipei 115, Taiwan

Entire contents copyright© 2016 CyberPower Systems Inc., All rights reserved. Reproduction in whole or in part without permission is prohibited. PowerPanel® Business Edition and PowerPanel® Personal Edition are trademarks of CyberPower Systems Inc.

