



TN50/TN50W Cloud Network Camera Quick Start Guide

Technical Support Information

For any problems you may encounter, please refer to the user's manual on the installation CD. If you need further assistance, you can fill out the online form (www.comprousa.com/feedback/) or email us at support@comprousa.com.

Compro Technology is the registered logo of Compro Technology, Inc. C4Home is the registered trademarks of AVSecur Technology, Inc. All other company and product names mentioned in this document are registered trademarks of the respective companies. No part of this document may be copied or reproduced in any form or by any means without the prior written consent of Compro Technology, Inc. The information in this document is subject to change without prior notice.

Compro Technology, Inc. www.comprousa.com

Tel. +886 2 2918 0169 | Fax +886 2 2915 2389

3GA0310854

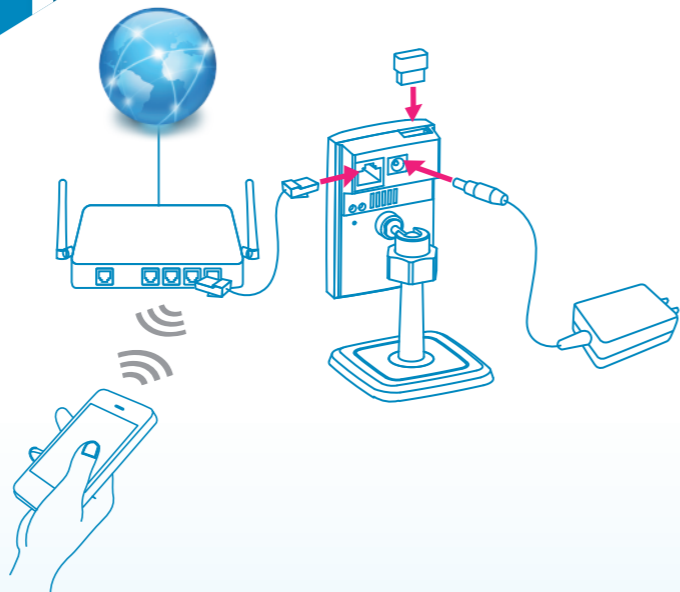

- Connect an Ethernet cable between IP camera and your network switch/router. (If you have purchased a Compro USB wireless adapter, please plug into the USB port of IP camera.)
- Attach the power adapter to the camera's power connector and connect the power plug to a power outlet.
- Make sure your smartphone is able to access the internet via your switch/router.



iPhone



C4Home app



Android



- Using iPhone or Android phone to scan the QR code above for download and install the C4Home app. (Also you can download the C4Home app from App Store or Google Play.)
- Start the C4Home app and register your personal account.



www.c4home.com

- Login the C4Home app and add new camera:
 1. Scan the QR code on the back side of camera (Or direct input the 10 digits camera ID under the QR code)
 2. Click "iWizard" to search/install camera from local network
- After installation, now you can watch the live video of camera from C4Home app or login to the www.c4home.com from PC.

Wireless Setup

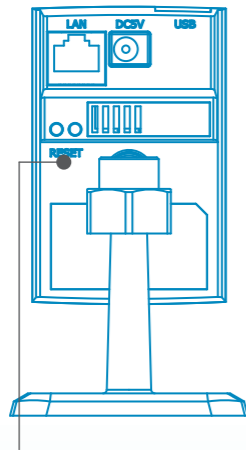

One-click the reset button to setup WPS

Search for available Wi-Fi access points and enter the passphrase manually

- Make sure the IP camera is connected to the local network via network cable.
- If you have the wireless adaptor for TN50, make sure it is plugged into the IP camera.
- The smartphone must be in the same local network in order to successfully search and configure the camera.
- Start C4Home app and enter "iWizard" on the "Add Camera" page to search your camera and set up wireless connection.
- After the wireless connection is successfully set up, you can remove the ethernet cable.

Using WPS setup

- Make sure your Wi-Fi router supports WPS, press the WPS button on the router and one-click the RESET button on the IP camera. The blue LED will be blinking during the WPS setup process and resume to steady lighting when the setup is completed.

Name of Each Part

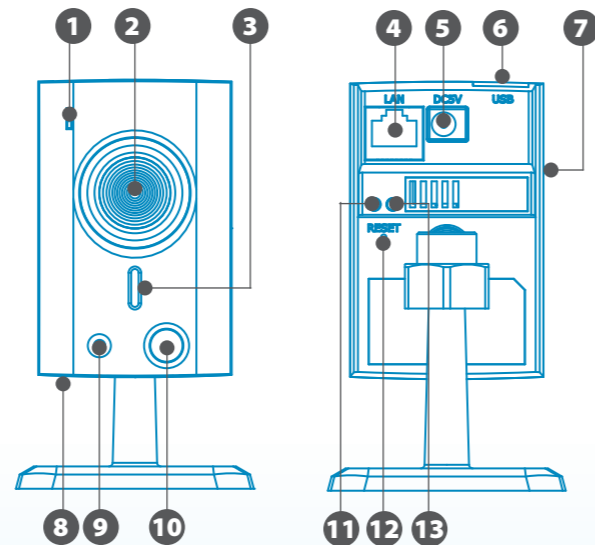

- | | |
|------------------------------|--|
| 1. LED status indicator | 8. Microphone pinhole
(on the bottom) |
| 2. Lens | 9. Illumination LED |
| 3. Speaker | 10. PIR Sensor |
| 4. Ethernet port | 11. Connection status indicator |
| 5. Power connector | 12. Reset button |
| 6. USB wireless adapter port | 13. Network speed indicator |

Mount the Camera

If desired, you can mount the camera on a wall or ceiling. The following section explains how to mount your camera.

- 1 Drill 2 mounting holes on the mounting surface. While you are at it, bear in mind that there will have to be a minimum space of 2.5 mm (0.098 inch) between the screw head and the mounting surface. Also, the 2 mounting holes on the wall or ceiling should be spaced exactly 31 mm (1.22 inch) apart to correspond to the position of screw holes on the camera's bracket base.

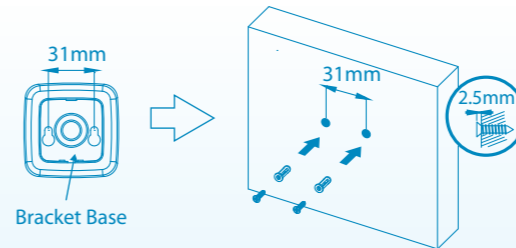

- 2 Loosen the fastening hex nut to detach the bracket from the camera.

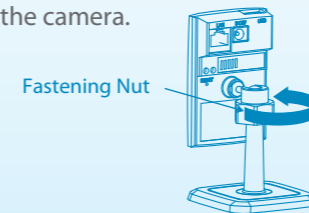

- 3 Remove the base cover by inserting a flat blade screwdriver into the small hole on the bracket base and then pressing the screwdriver downward.

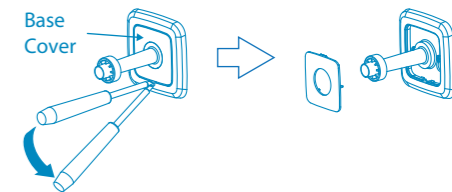

- 4 Put a screw into each of the mounting holes. Then secure the bracket to the mounting surface.

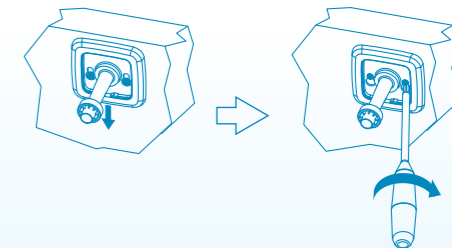

- 5 Finally, click the base cover back into position. After that, attach the camera body back to the bracket and then adjust the camera to the desired viewing angle.

