

Brickcom

Megapixel Cube Network Camera
CB-100A/CB-500A Series

User's Manual

Quality Service Group

Product name: Network Camera (CB-100A/CB-500A series)

Release Date: 2011/7

Manual Revision: V2.1

Web site: www.brickcom.com

Email: technical@brickcom.com

info@brickcom.com

©2011 Brickcom Corporation. All Rights Reserved

Table of Contents

Before You Use This Product	0
FCC Warning	0
Regulatory Information.....	1
Product Comparison	0
Package Contents.....	0
Cube Network Camera Overview.....	2
Device Appearance Description	4
LED Behavior.....	5
Installation.....	7
System Requirements	7
Camera Connection	8
Basic Connection.....	8
Software Installation	9
EasyConfig	16
Accessing the Network Camera.....	25
Check Network Settings	25
Add Password to Prevent Unauthorized Access	25
Authentication.....	25
Installing the Plug-In	26
Live View.....	27
Configuration.....	30
Camera/Video/Audio	30
Camera.....	30
Video.....	32
Audio.....	36
Multicast.....	37
Privacy Mask Control.....	38
Network	39
IP Settings	39
UPnP	41
DDNS (dynamic domain name service)	42
EasyLink™	43
Wireless.....	45
HTTP/HTTPS.....	51
Event	54
Event Settings.....	54

Motion Detection	58
PIR(*)	59
Audio Detection	59
Notifications.....	60
FTP Settings	60
E-mail Settings.....	61
Samba Settings	61
HTTP Settings	62
Video Clip	63
Audio Clip(*).....	64
LED Light(*)	65
System	66
System Log	66
Date and Time	67
Device Information.....	68
Storage Management(*).....	70
LED Indicators	71
Maintenance.....	73
User Management	73
Language.....	74
IP Filter	74
Firmware Upgrade	75
Configuration	75
Reset to Default	76
Reboot	76



Before You Use This Product

In many countries, there are laws prohibiting or restricting the use of surveillance devices. This Network Camera is a high-performance, web-ready camera which can be part of a flexible surveillance system. It is the user's responsibility to ensure that the operation of this camera is legal before installing this unit for its intended use.

Upon opening the product's package, verify that all the accessories listed on the "Package Contents" are included. Before installing the Network Camera, read the warnings in the "Quick Installation Guide" to avoid misuse. When installing the Network Camera, carefully read and follow the instructions in the "Installation" chapters to avoid damages due to faulty assembly or installation.

FCC Warning

This device complies with Part 15 of FCC rules.

Operation is subject to the following two conditions;

- (1) This device may not cause harmful interference, and
- (2) This device must accept any interference received, including interference that may cause undesired operations.



Regulatory Information

Federal Communication Commission Interference Statement

This equipment has been tested and found to comply with the limits for a Class B digital device, pursuant to Part 15 of the FCC Rules. These limits are designed to provide reasonable protection against harmful interference in a residential installation. This equipment generates uses and can radiate radio frequency energy and, if not installed and used in accordance with the instructions, may cause harmful interference to radio communications. However, there is no guarantee that interference will not occur in a particular installation. If this equipment does cause harmful interference to radio or television reception, which can be determined by turning the equipment off and on, the user is encouraged to try to correct the interference by one of the following measures:

- Reorient or relocate the receiving antenna.
- Increase the separation between the equipment and receiver.
- Connect the equipment into an outlet on a circuit different from that to which the receiver is connected.
- Consult the dealer or an experienced radio/TV technician for help.

FCC Caution: Any changes or modifications not expressly approved by the party responsible for compliance could void the user's authority to operate this equipment.

This device complies with Part 15 of the FCC Rules. Operation is subject to the following two conditions: (1) This device may not cause harmful interference, and (2) this device must accept any interference received, including interference that may cause undesired operation.



IMPORTANT NOTE:

FCC Radiation Exposure Statement:

This equipment complies with FCC radiation exposure limits set forth for an uncontrolled environment. This equipment should be installed and operated with minimum distance 20cm between the radiator & your body.

This transmitter must not be co-located or operating in conjunction with any other antenna or transmitter.

The availability of some specific channels and/or operational frequency bands are country dependent and are firmware programmed at the factory to match the intended destination.

The firmware setting is not accessible by the end user.



Product Comparison

Model Name		Lesns	Resolution	DI/DO	WiFi	PoE	USB port for 3G/ 4G
CB-100A Series	CB-100Ap	Board Lens	1280x800	-	-	-	-
	WCB-100Ap	Board Lens			✓	-	-
	CB-101Ap V2.1	Board Lens		✓(1/1)	-	✓	✓
	CB-102Ap V2.1	CS Mount			-	✓	✓
CB-500A Series	CB-500Ap	Board Lens	2592 x 1944 pixel	✓(1/1)	-	✓	✓
	WCB-500Ap	Board Lens			✓	-	-
	CB-502Ap	CS Mount			-	✓	✓
	WCB-502Ap	CS Mount			✓	-	-

Package Contents

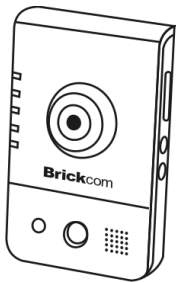
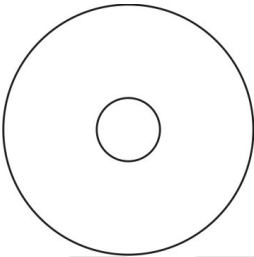
Please check to make sure the product package contains all the accessories listed below.

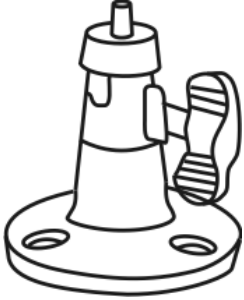
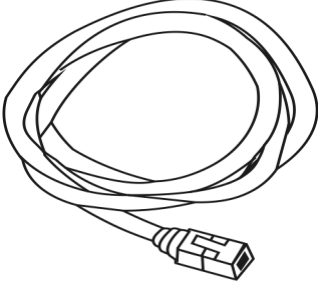
<p>a. CB-100A/CB-500A Series</p> 	<p>b. Product CD</p> 
--	---

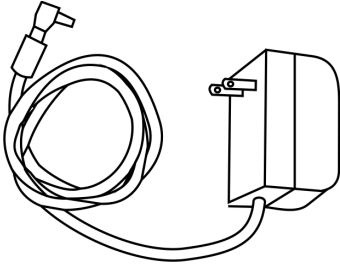
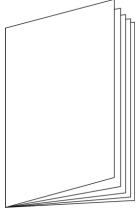
<p>c. Camera Stand</p> 	<p>d. White Flat RJ-45 cable(1.5m)</p> 
<p>e. Warranty Card</p> 	<p>f. Power Adapter</p> 
<p>g. Easy Installation Guide</p> 	

Cube Network Camera Overview

The compact Brickcom CB-100A/CB-500A series Cube network series offers a high quality, video surveillance solution for residences and small businesses. Unlike a general webcam, this camera series is a standalone surveillance system that does not need to be connected to a computer. EasyLink™ is a feature of the CB-100A/CB-500A series camera which allows for users to simply plug in the camera to any home or small business network and play the video.

This camera series offers a user-friendly and unique design which allows anyone without a technical background to use it. It features live video feed and two-way audio which can be used over a local area network (LAN), through any internet browser, or via any 3G mobile device. The wireless capability makes it easy to mount on any surface. The CB-100A/CB-500A series features many cutting edge functions and its fashionable, streamline design make it the perfect additional for any home or office.

Because of its many advanced features, the CB-100A/CB-500A series has many versatile applications. Users can easily monitor the safety of their family members, pets, office, valuables, and property.



Small Office Surveillance –

Security systems for small offices can be expensive and difficult to install and maintain. With the EasyConfig software, the CB-100A/CB-500A series can easily be installed and configured by anyone without extensive technical knowledge. The video can be reviewed remotely so business owners can monitor office safety and employee productivity at all times.



Residence monitor –

Home owners worry about their house and property when they are away. The CB-100A/CB-500A series has a built-in PIR sensor which can detect unauthorized movement in a residence. Once movement is detected, the illumination LED will be triggered and an alert with a snapshot can be emailed or sent through an MMS to the user's portable device.



Elderly and Child Care –

A high concern for many people is the safety of elderly relatives and small children. Users can use the CB-100A/CB-500A series camera to ensure the safety of their loved ones by use of the live view and intercom functions.



Pet Monitor –

The motion detection feature can be used to create forbidden areas in the home which the pet should not enter when the owner is away. If the camera records the pet entering the region, a recorded message can be programmed to play and the owner will be notified via email or MMS.

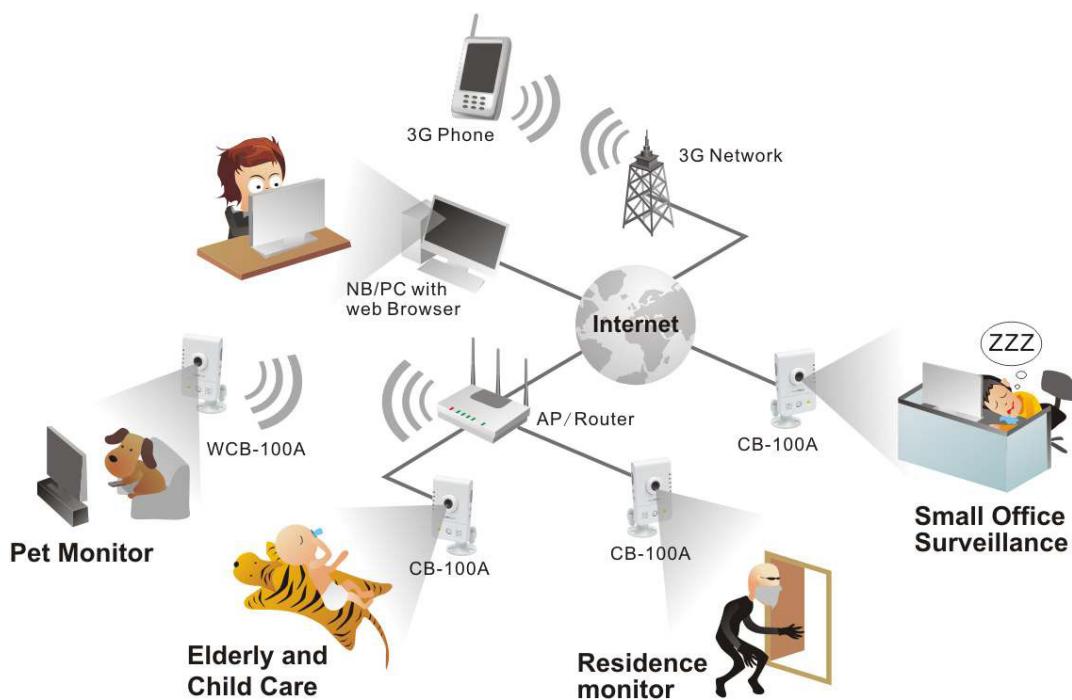



Device Appearance Description

< Front & Rear view >

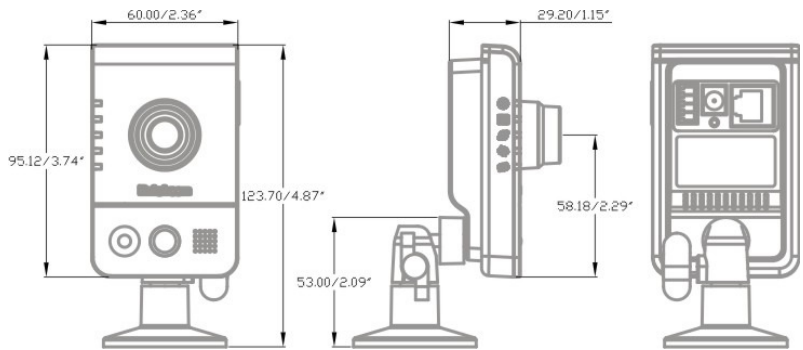
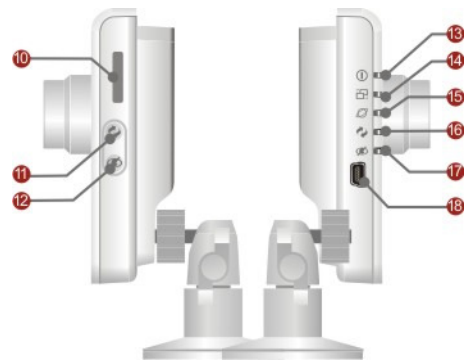

- 1 Adjustable focal Lens
- 2 Built-in Microphone
- 3 PIR
- 4 Illumination LED
- 5 Speaker
- 6 Power Connector
- 7 Ethernet RJ45 Socket
- 8 Reset Button
- 9 DIDO Terminal I/O Connector
- 10 Micro SD/SDHC slot
- 11 WPS button
- 12 Privacy button
- 13 Power LED
- 14 Status LED
- 15 Internet LED
- 16 WPS LED
- 17 Privacy LED
- 18 USB Port for 3G/4G



1.  NOTE - The WPS and Privacy buttons must first be enabled through the web GUI in order to work. See page 37 for details on how to enable the Privacy button and see page 50 for details on how to enable the WPS Button.
2. (*) These are optional features. Please refer to the Product List for the full list of optional features available for the product.

LED Behavior

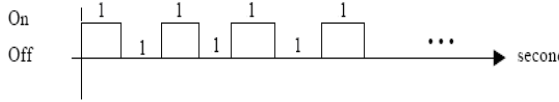
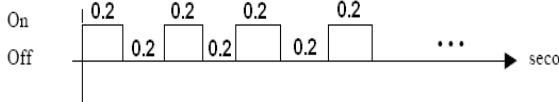
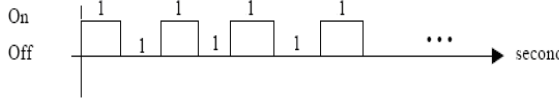
Function	LED Behavior	Description	Remark
Power	Continuous Illumination	Normal Operation	Top (Blue)
Power	Unlit	Powered off	Top (Blue)
Status	Continuous Illumination	1. Connected to switch by Ethernet or WiFi. 2. Reset to default.	Second (Blue)
Status	Unlit	1. Powered off 2. No connection	Second (Blue)
Status		1. Upgrading F/W 2. Performing site survey	Second (Blue)
Status	Blinking	1. Connecting to the network 2. Restoring settings.	Second (Blue)
Internet	Continuous Illumination	Connected to Internet	Third (Blue)
Internet	Unlit	1. Powered off 2. No connection	Third (Blue)
WPS		WPS in progress	WCB-100A/C B-500A SERIES Fourth (Blue)
WPS		WPS Connection Error	WCB-100A/C B-500A SERIES Fourth (Blue)

WPS		Session overlap detected	WCB-100A/C B-500A SERIES Fourth (Blue)
WPS	Continuous Illumination	WPS success	WCB-100A/C B-500A SERIES Fourth (Blue)
Firmware Upgrade	Continuous Illumination	Firmware successfully upgraded	CB-100A/CB-500A SERIES Fourth (Blue)
Privacy	Continuous Illumination	Privacy mask active	Bottom (Red)
Privacy	Unlit	Privacy mask inactive	Bottom (Red)

Hardware Reset

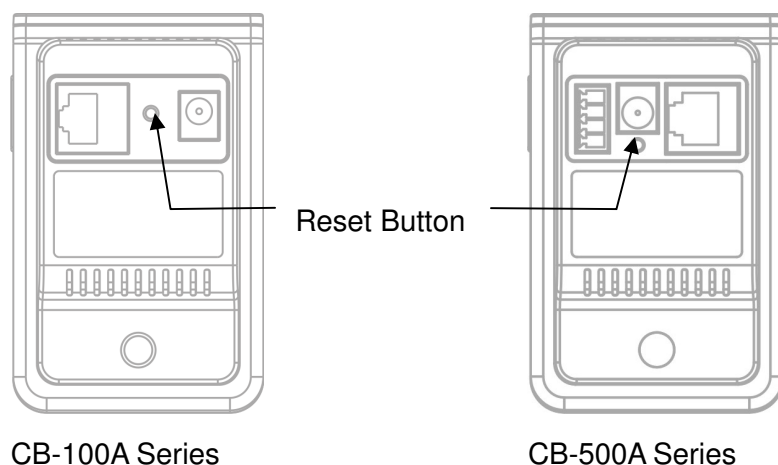

CB-100A Series

CB-500A Series

The Reset Button can be used to reboot the camera or restore it to factory default settings. If the camera experiences a problem, rebooting the camera may correct the problem. If the problem remains, please restore the camera to factory default settings and reinstall the software.

To Reboot - Press and hold the Reset Button for one second using a paper clip or thin object. Wait for the camera to reboot.

To Restore – Press and hold the Reset Button for ten seconds until the LED light turns off. When successful restored, the LED will be blue during normal operation.



NOTE - By restoring the camera, all settings will be restored to the factory default settings.

Micro-SD/SDHC Card Capacity

The network camera is compatible with Micro-SD/SDHC (Maximum 32GB) cards.

Installation

System Requirements

Operating System:

Microsoft Windows XP Home Edition SP2

Microsoft Windows XP Professional SP2

Computer:

IBM PC/AT Compatible

CPU:

Pentium 3GHz or faster

Memory:

1024 MB or more

Monitor:

1024 x 768 pixels or more, 24-bit True color or better

Network Interface:

10/100Mbps Network interface card must be installed

Web Browser:

Microsoft Internet Explorer 6.0 SP2 or higher

Adobe Reader:

Adobe Reader 8.0 or higher

Audio:

The audio function will not work if a sound card is not installed in the PC. Audio may be interrupted depending on network traffic.

Camera Connection

Basic Connection

1. Connect the supplied power cable from the camera to a power outlet.
2. Connect the camera to a switch using an Ethernet cable.

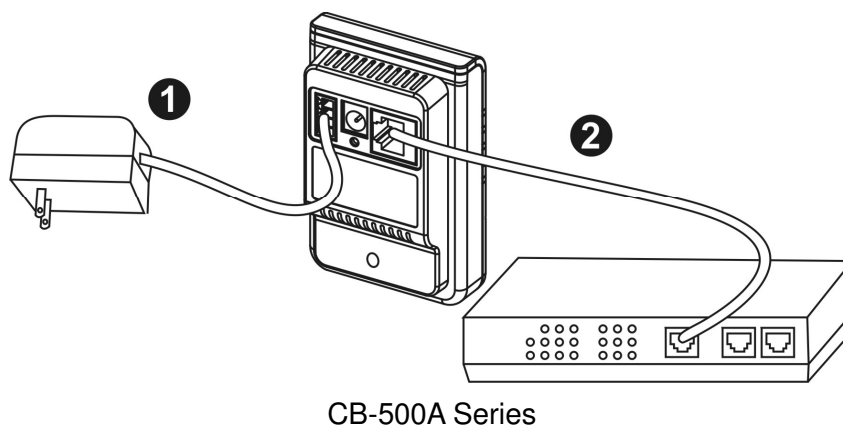
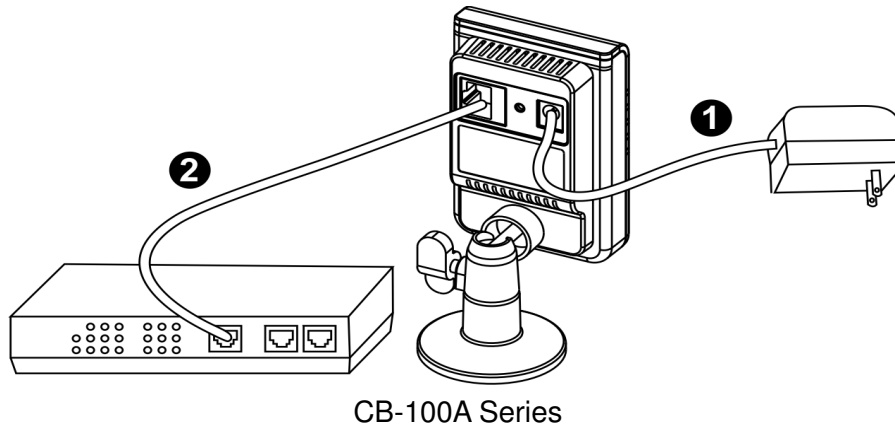

When powering up, the power LED will light up and the camera will boot up. The status LED will turn amber when the camera is obtaining the IP address. After obtaining the IP address, the link LED will flash orange while the network connection is processing.

Software Installation

In this manual, "User" refers to whoever has access to the Network Camera, and "Administrator" refers to the person who can configure the camera and grant user access to the camera.

After checking the hardware connection, run the Installation Wizard program included on the product's CDROM to automatically search the intranet for the camera. There may be many cameras on the local network. Differentiate the cameras using the serial number which is printed on the labels on the carton and the bottom of the camera.

1. Insert the Installation CD into the CD-ROM driver. Run Auto-Run Tool directly from the CD-ROM to start the installation. When installing the Brickcom software kit for the first time, select a desired language for the interface. The available languages are listed in the scroll box. Click **<Install>** and follow the steps to install the EasyConfig wizard on the desired computer.



2. In the Install Shield Wizard dialog box, click <Next> to continue.

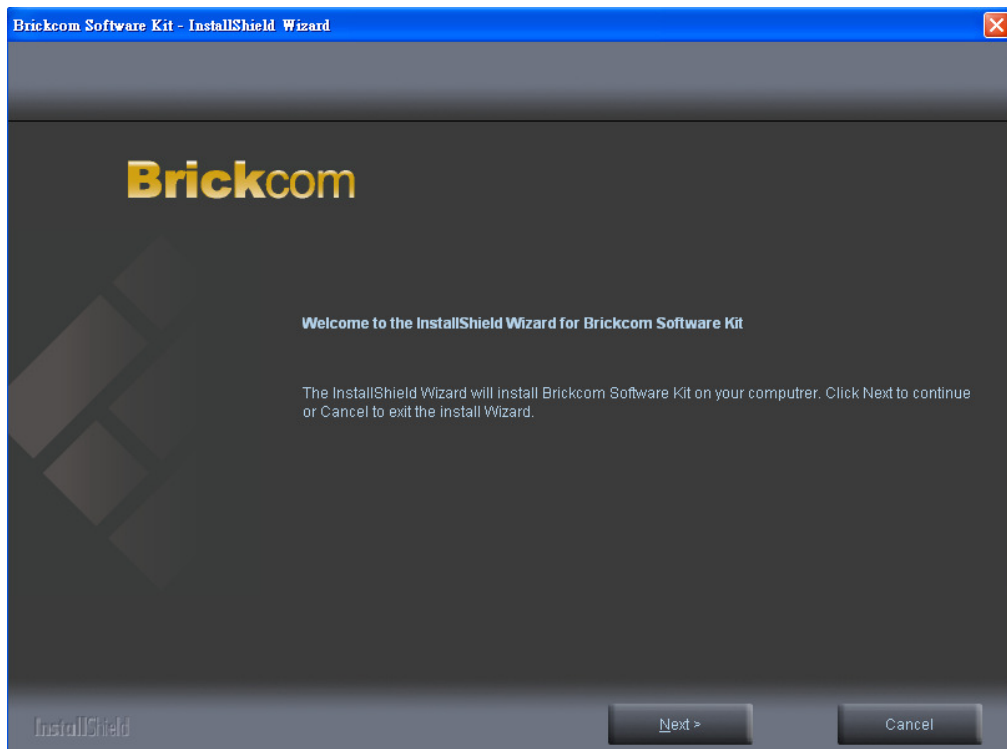

3. Read the End-User License Agreement and check the option "I accept the terms of the license agreement". Click <Next> to continue.

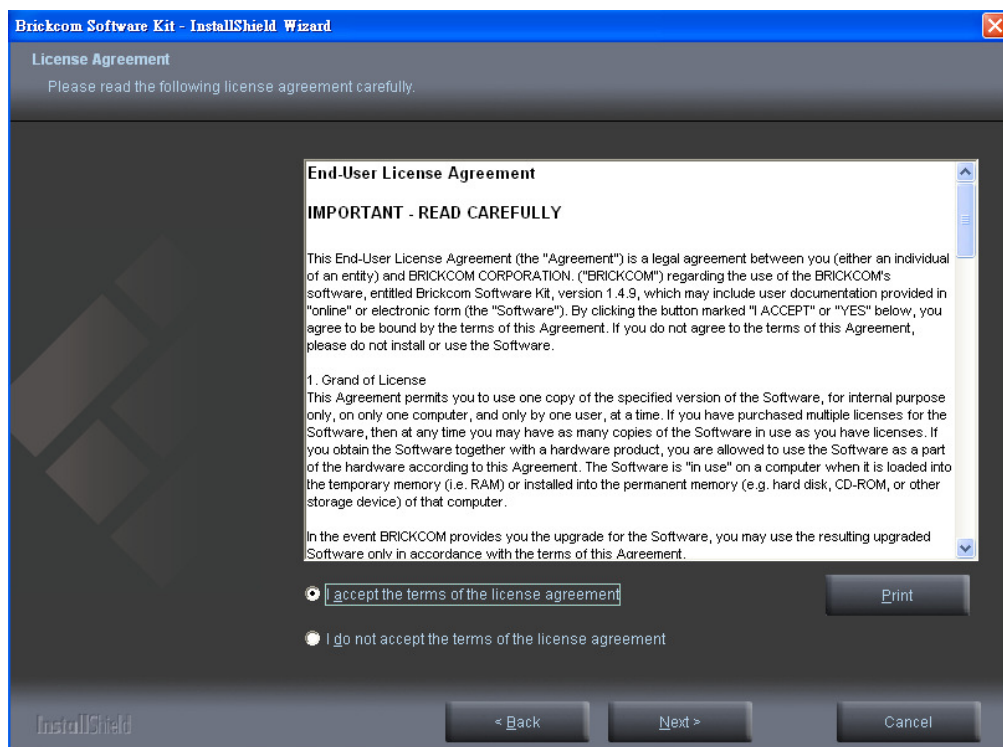

4. Select either “Complete” setup or “Custom” setup to install the system.
 - a. **If COMPLETE SETUP is selected:**
 - i. **All program features** will be installed into the default directory. Check the option “**Complete**” and then click <Next>.

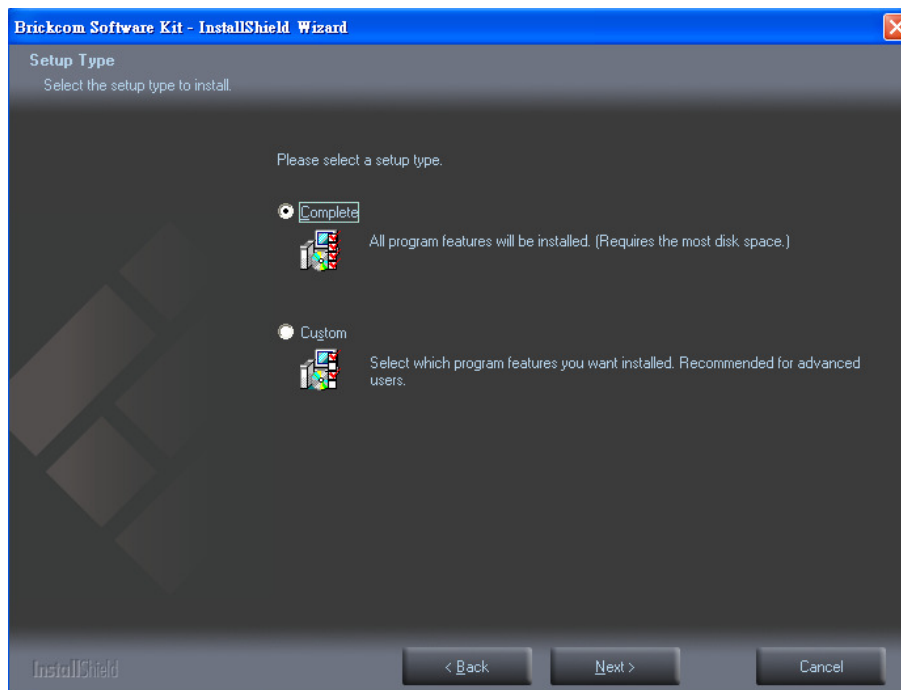

- ii. Select to create shortcuts. Click <Next> to continue.

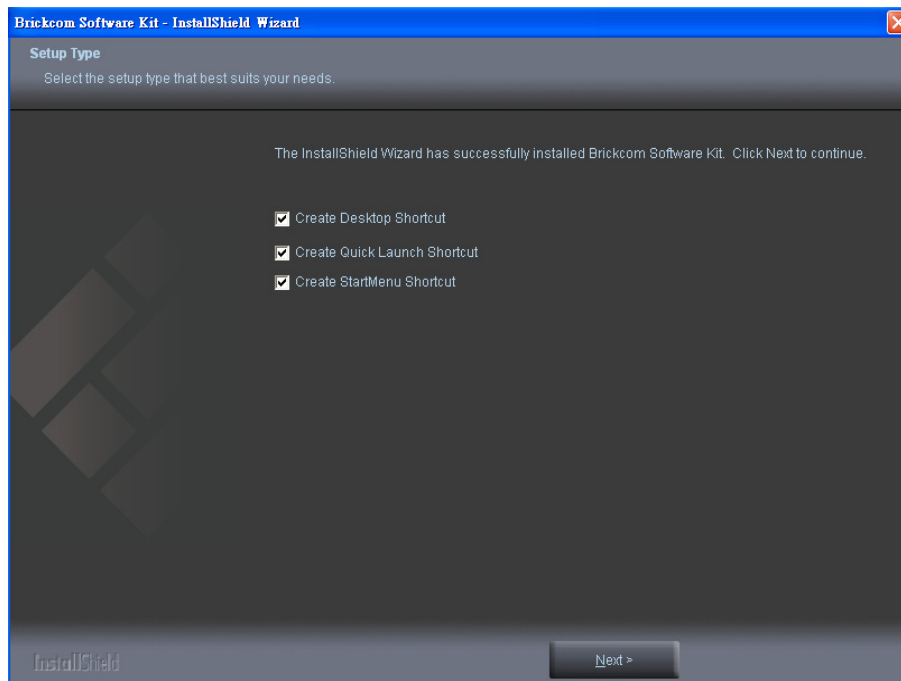

- iii. The installation information will be displayed. Click <Next> to continue.

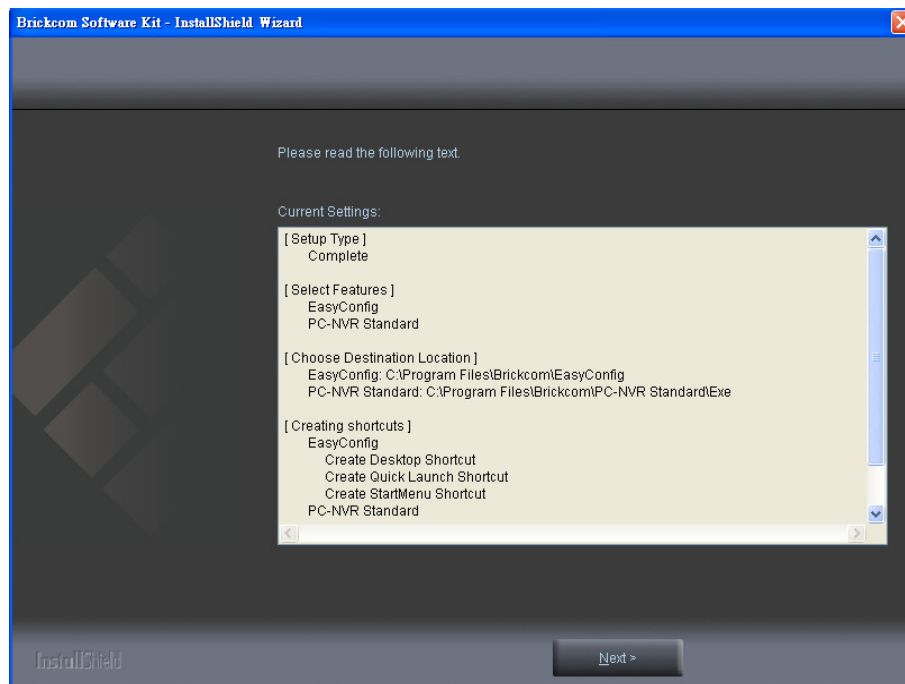

b. **If CUSTOM SETUP is selected:**

- i. This option is recommended for advanced users. It can be used to install the system to a preferred directory or to select specific program feature(s).
- ii. Check the option “**Custom**”, and then click <Next>.

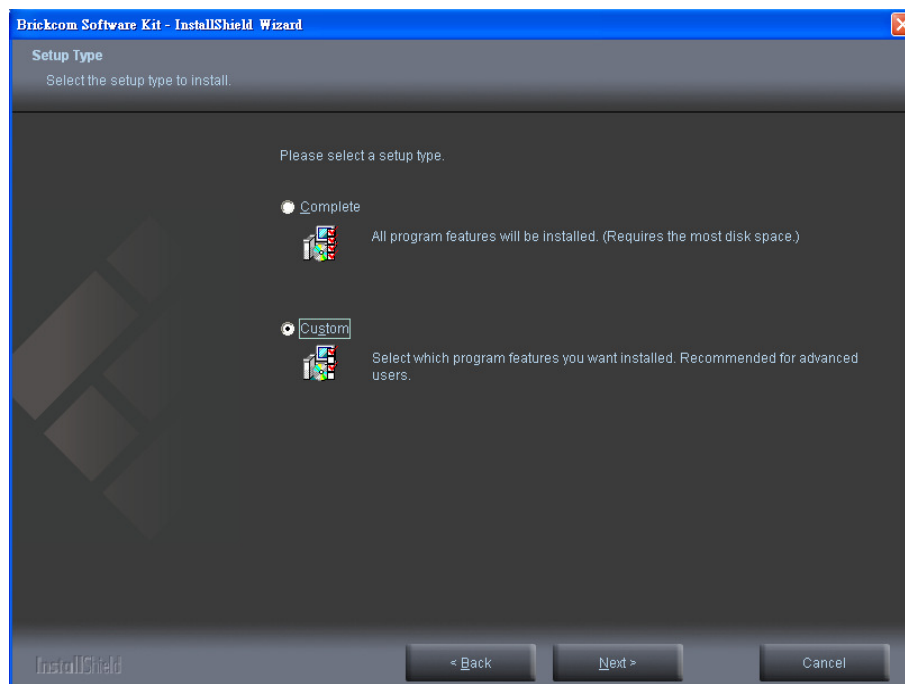

iii. Select the features to install. Click <Next> to continue.

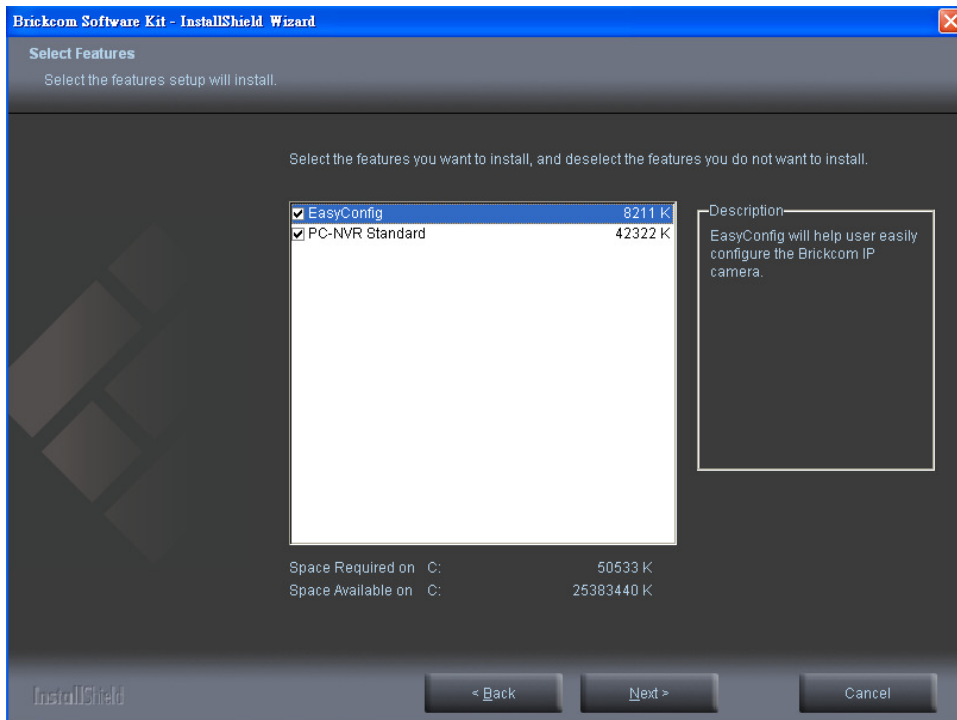

iv. Click <Change> to change the appointed folder where installation and program files will be stored. Click <Next> to continue.

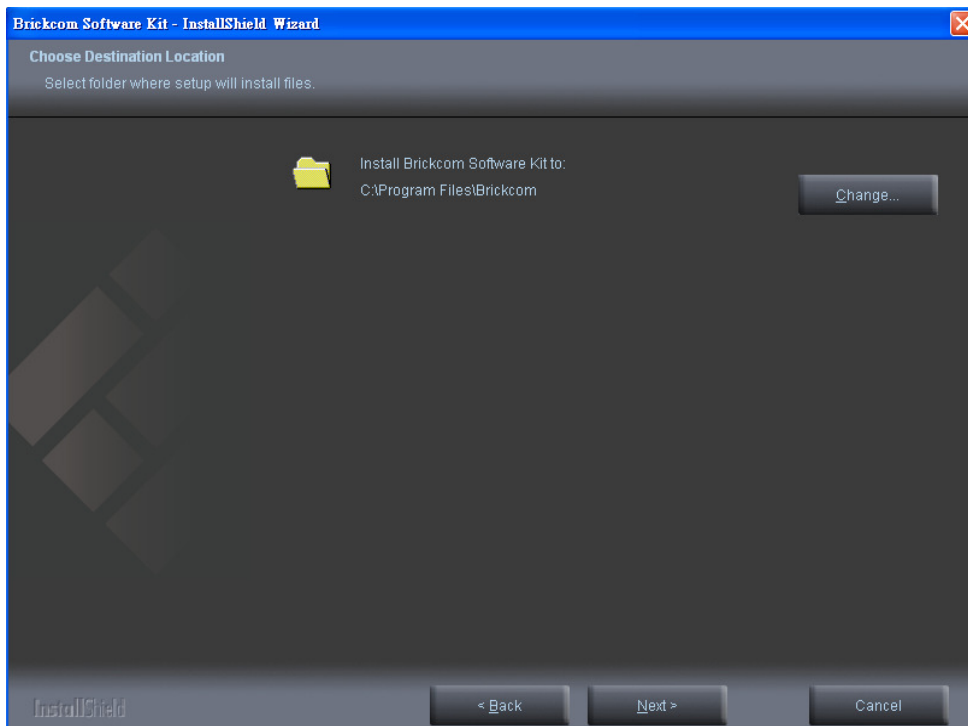

v. Select programs to create shortcuts. Click <Next> to continue.

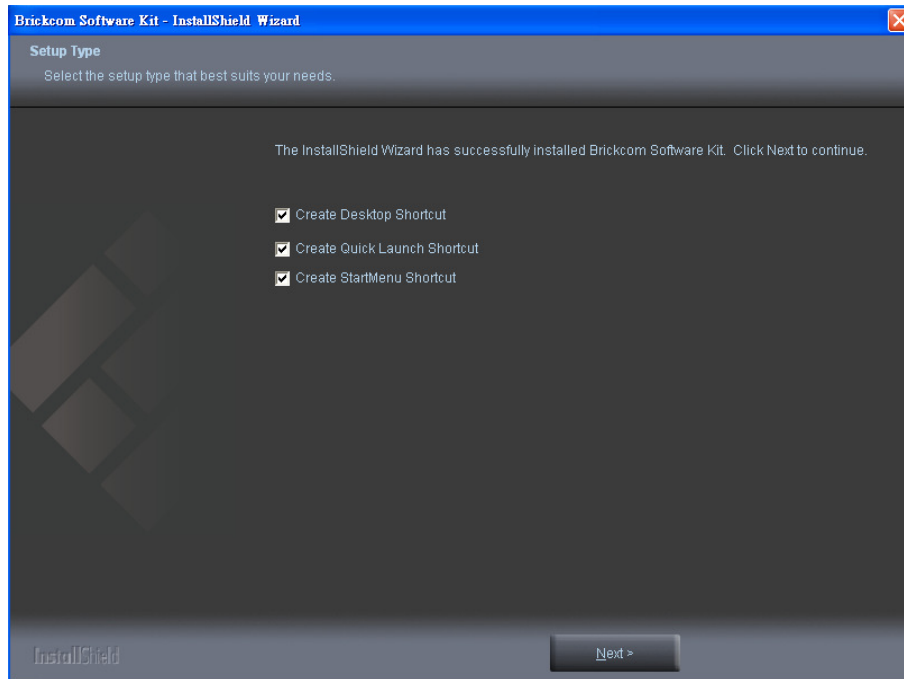

vi. The installation information will be displayed. Click <Next> to continue.

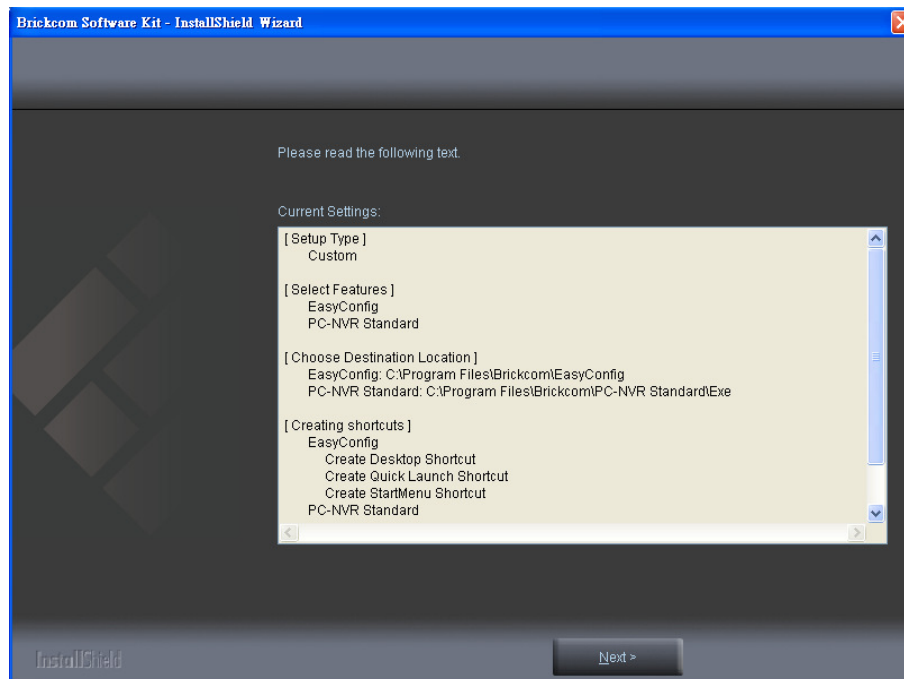

5. To launch EasyConfig or PC-NVR Standard, select the application and click <Finish>. When launching the PC-NVR program, please refer to the PC-NVR user manual.

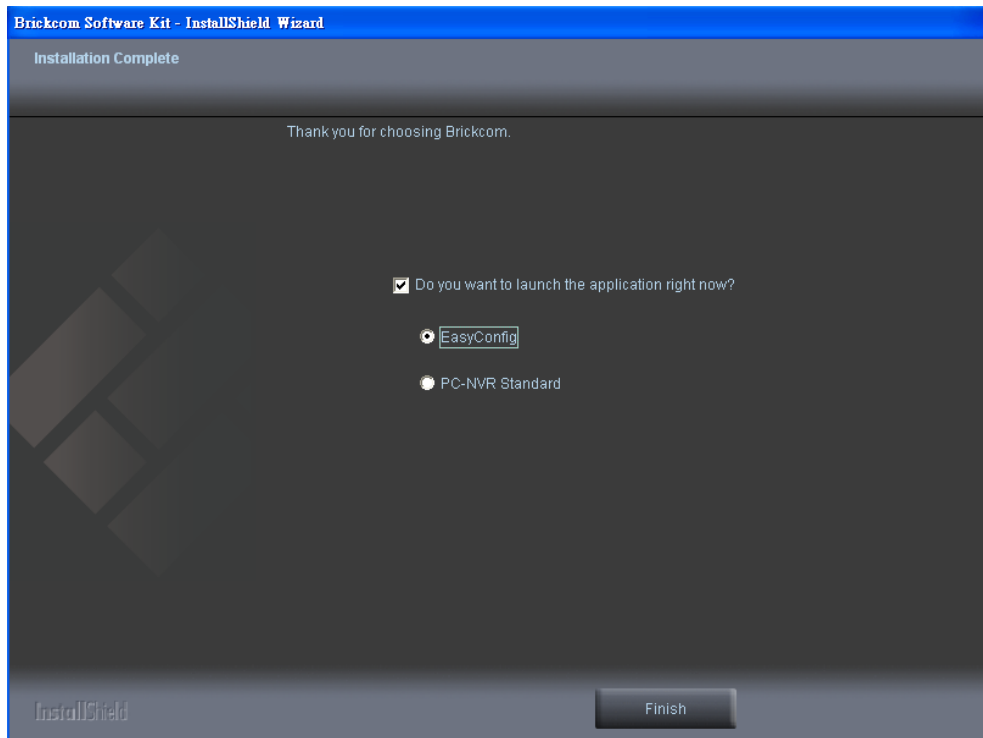

EasyConfig

To launch EasyConfig, select EasyConfig from the start menu. If Complete Setup type was used in the software installation, an EasyConfig icon was installed on the desktop. Double click to open the icon.



If Custom Setup type was used in the software installation and an EasyConfig icon was not installed on the desktop, the program will be installed under C:\Program Files\Brickcom\EasyConfig unless the program was saved to a preferred directory.

1. Click **<Start>** to continue. The program will automatically search for the camera in the intranet.



NOTE - Check “Skip the hardware installation guide” to skip checking the hardware connection. To check the hardware installation settings, do not check the option box.



Brickcom

Connection

1 Plug one end of the supplied network cable into your network switch or router.

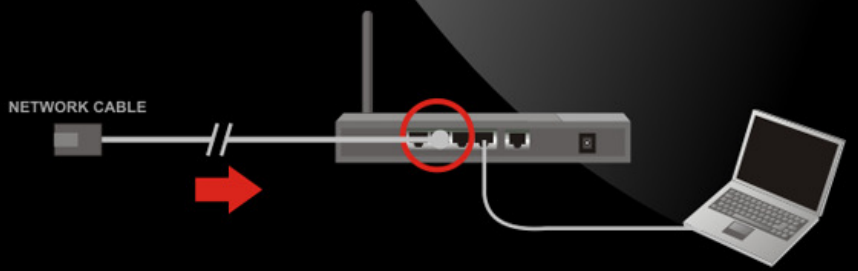

NETWORK CABLE

Diagram illustrating the first step of connection: a network cable is being plugged into the Ethernet port of a network switch or router. The router is connected to a laptop. A red circle highlights the Ethernet port on the router, and a red arrow points to the network cable being inserted into it.

Brickcom

2 Plug the other end of the supplied network cable into the camera's Ethernet port.

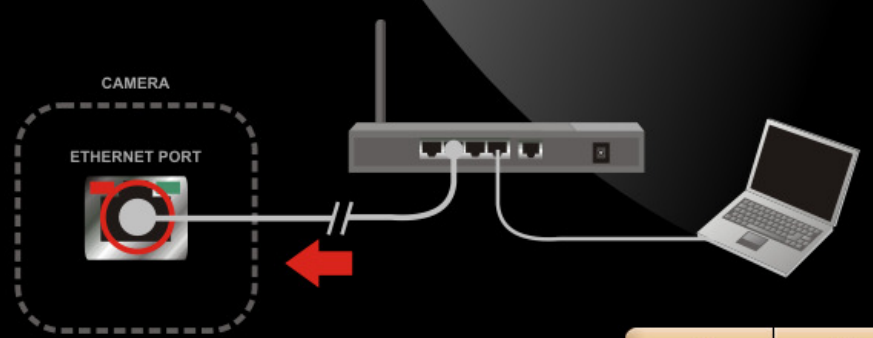

CAMERA

ETHERNET PORT

Diagram illustrating the second step of connection: the other end of the network cable is being plugged into the Ethernet port of the camera. The camera is connected to a router, which is connected to a laptop. A red circle highlights the Ethernet port on the camera, and a red arrow points to the network cable being inserted into it.

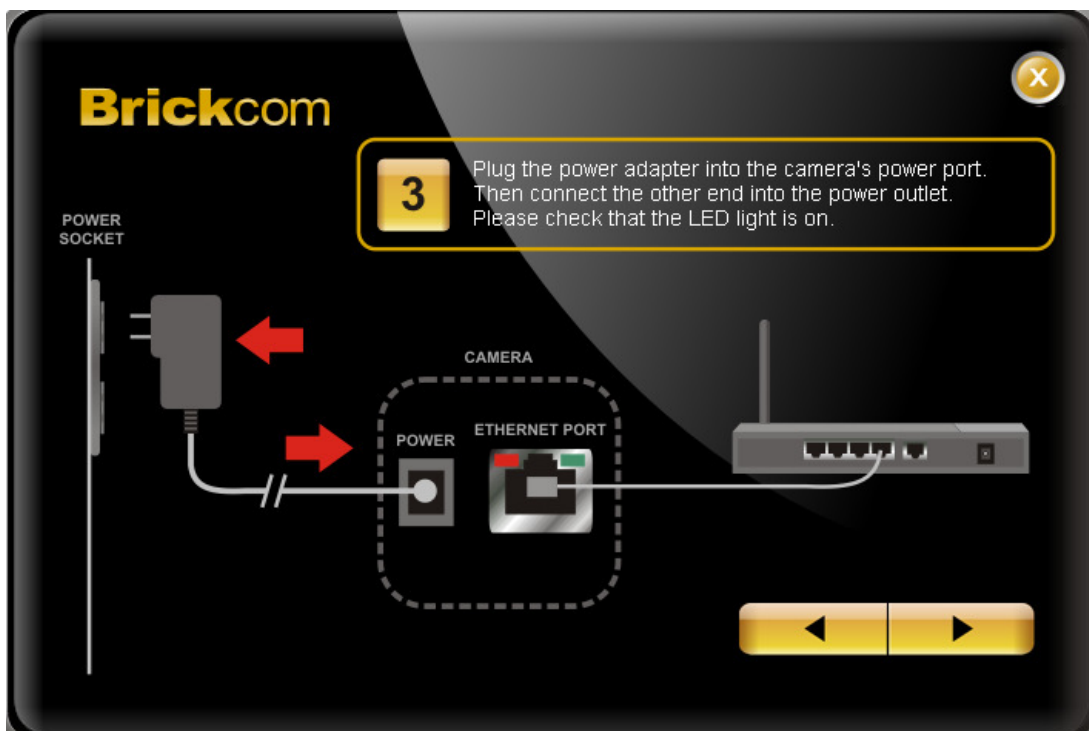

2. Select either "Simple Mode" or "Professional Mode" to obtain the camera's IP settings. If "Simple Mode" is selected, EasyConfig will set up the connection automatically. If "Professional Mode" is selected, the user will need to configure the IP settings manually.



3. There may be many cameras in the local network. Differentiate the cameras using their UPnP name. Double click on the camera from the survey list to connect.

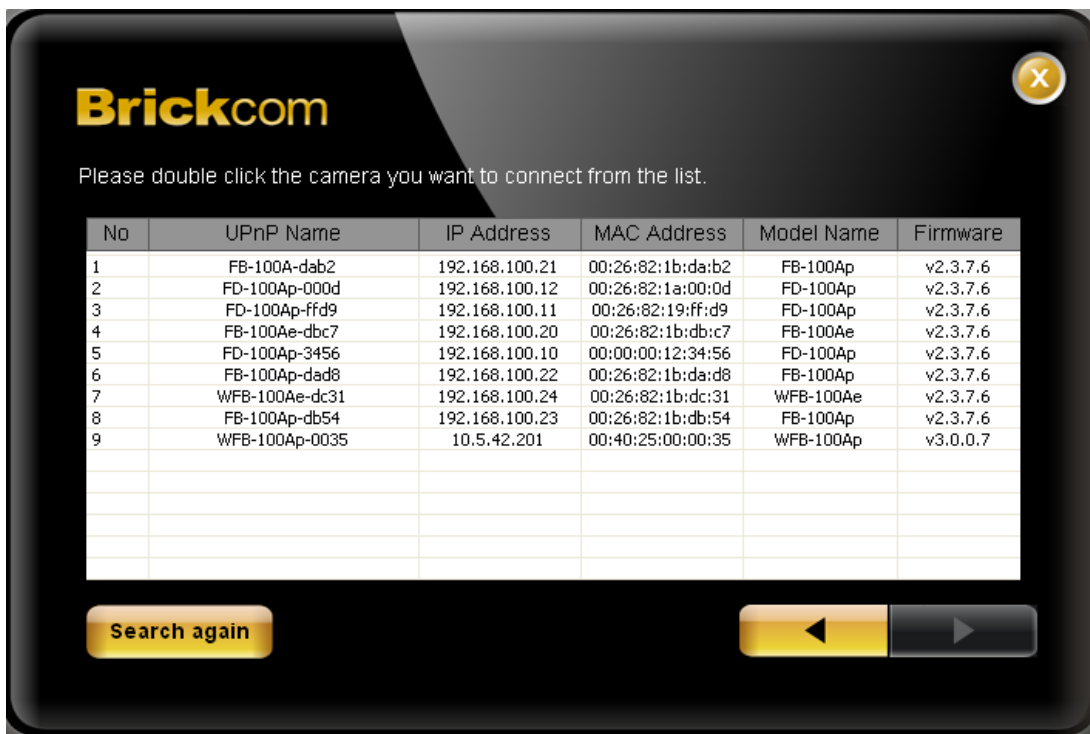

4. Enter the username and password of the camera. For first time use, the default username and password are “**admin/admin.**”

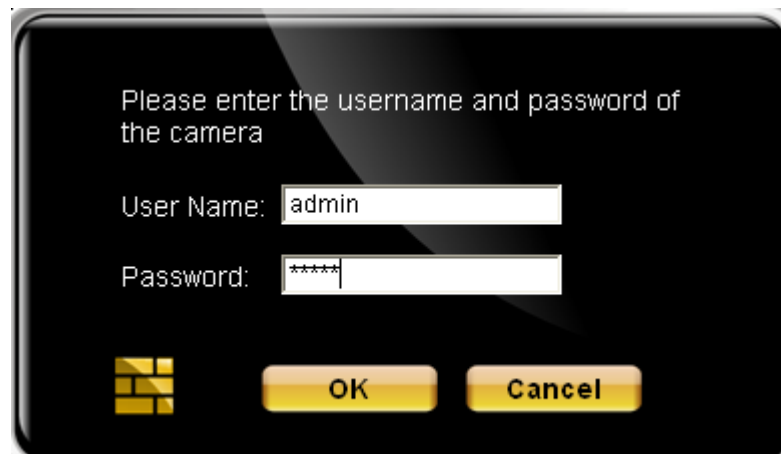

5. For configuring the IP address settings, select either <Settings remain the same>, <Automatically obtain an IP Address (DHCP)> or <Set IP Address configuration manually>. The DHCP setting is recommended.



- a. If <Set IP Address configuration manually> is selected, the following pages will be displayed.

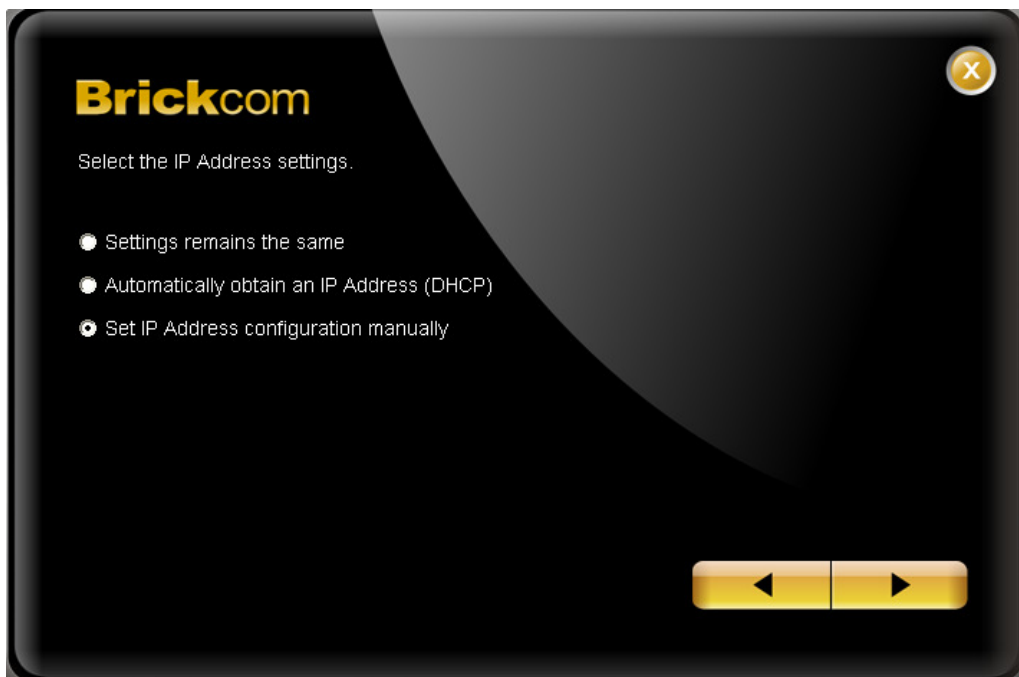

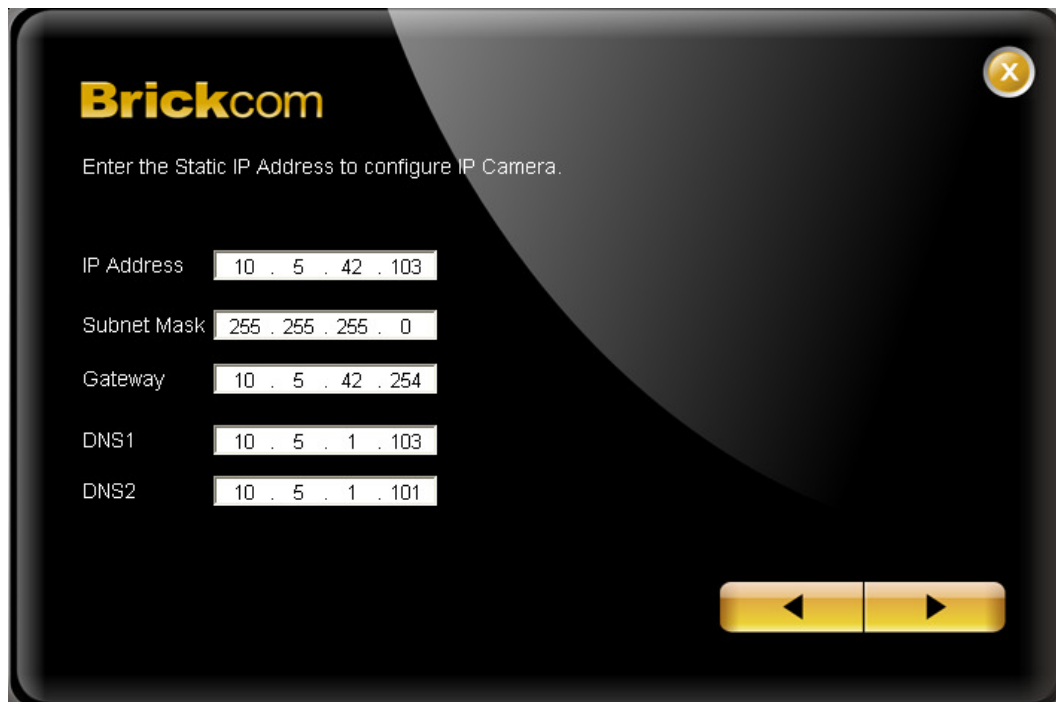

6. If the camera supports the EasyLink™ function, the following page will be displayed. Otherwise, this page will not be shown. *If desired, click <Skip> to skip this setting.

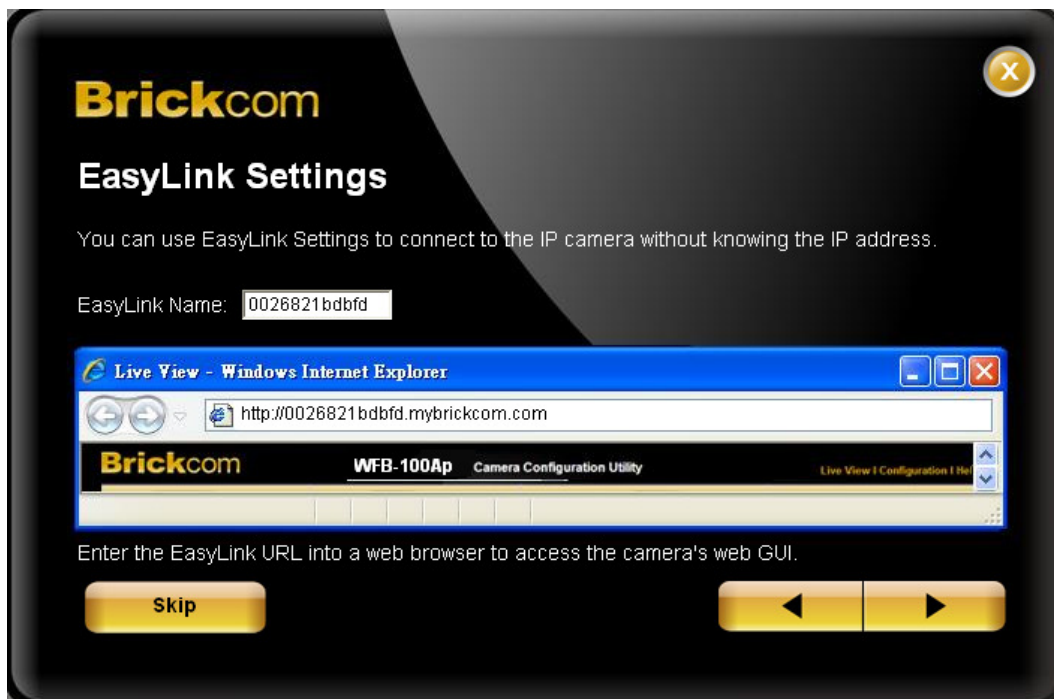

EasyLink™ is a unique Brickcom function which allows users to assign a unique EasyLink name to their network camera's IP address. There is no need to configure the router to open up ports or remember hard-to-memorize IP addresses. When this feature is enabled, users can log onto [uniqueEasyLinkname].mybrickcom.com to view the camera's web GUI and live view.

1. Enter a unique EasyLink name whose length must be between 5-32 characters.
2. When finished, click the arrow button to continue.
3.  **NOTE** - See [page 42](#) for more details about the EasyLink function.

7. When the IP address settings have been configured, the screen will either display a successful or failed connection message. If the connection failed, either try again or quit the installation.

a. If “DHCP IP address settings” was selected, the failure page will be displayed as below:



b. If “Static IP address settings” was selected, the failure page will be displayed as below:

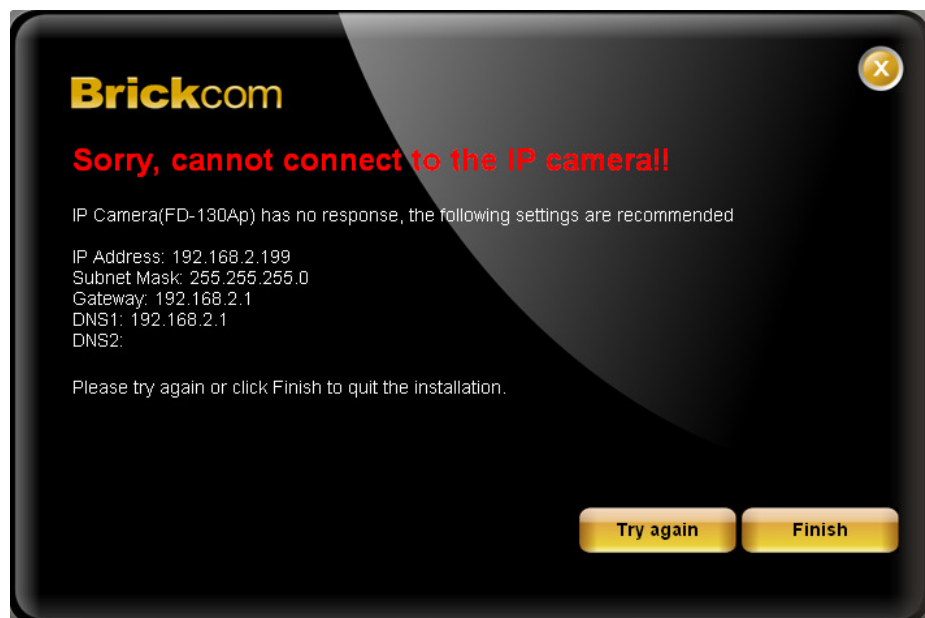

- c. If the connection was successful, the user will see the message:
"Congratulations. The installation of the camera is complete."

When this window is displayed, click **<PC-NVR>** to start the PC-NVR program, **<Live View>** to view the live video from the connected IP camera, or **<X>** in the top right corner of the screen to close the installation window. To run the PC-NVR program, please refer to the PC-NVR user manual for more information.



Once installation is complete, the Administrator should proceed to the next section "Accessing the Network Camera" for necessary changes and configurations.

Accessing the Network Camera

Check Network Settings

The camera can be connected either before or immediately after the software installation. The Administrator should complete the network settings on the configuration page, including entering the correct subnet mask and IP address of gateway and DNS. Ask the network administrator or Internet service provider for the detail information.

Add Password to Prevent Unauthorized Access

The Administrator should immediately implement a new password as a matter of prudent security practice. For first time use, the user name and password for the Administrator are assigned as “admin/admin”. After the Administrator changes the Administrator password, the web browser will display an authentication window to confirm the new password. Once the password is set, there is no provision to recover the Administrator’s password. If the Administrator’s password is lost, the only option is to restore the original factory default settings.

The Administrator can set up a maximum of ten (10) user accounts. Users will be able to access the Network Camera, but will not be allowed to access system configurations.

Authentication

To access the camera’s live view, open a web browser and enter the IP address of the camera. A dialog window will pop requesting a username and password. As stated on the previous page, for the default username and password for the Administrator are assigned as “**admin/admin**”. For accounts other than the administrator’s account, the user can choose to remember the password for future convenience. It is not recommended to check this box when viewing the camera feed from a public computer.

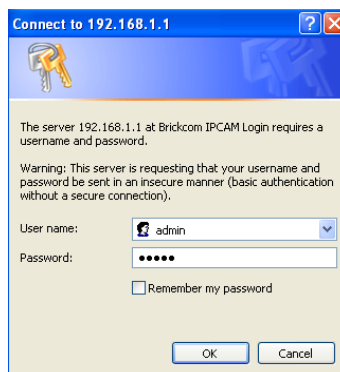

Installing the Plug-In

For the initial access to the camera in Windows, the web browser may prompt the administrator for permission to install a new plug-in for on Internet Explorer. Permission request depends on the Internet security settings of the user's PC or notebook. If the highest security level is set, the computer may prohibit any installation and execution attempt. This plug-in has been registered for certificate and is used to display the video in the browser.

Click on  to proceed. If the web browser does not allow the administrator to continue the installation, check the Internet security option and lower the security levels or contact the networking supervisor or IT for help.



 **NOTE** – If an error occurred or the plug-in fails to install, it is because the version of the Electronic Signature is newly released and the VeriSign has not been submitted to Microsoft Windows update for validation. Therefore, plug-in will not have its root certificate. If IE discovers that there is no root certificate after the user's PC connects to the camera, it will automatically redirect to VeriSign Web site to download and install the latest root certificate to make the installation successfully. If the user's computer is able to connect to camera but unable to access the internet, then the installation will fail because the computer will not be able to download the latest root certificate. This problem can be resolved if computer can be connect to the internet and the camera at the same time and will not recur when Windows update patches become available.

Live View

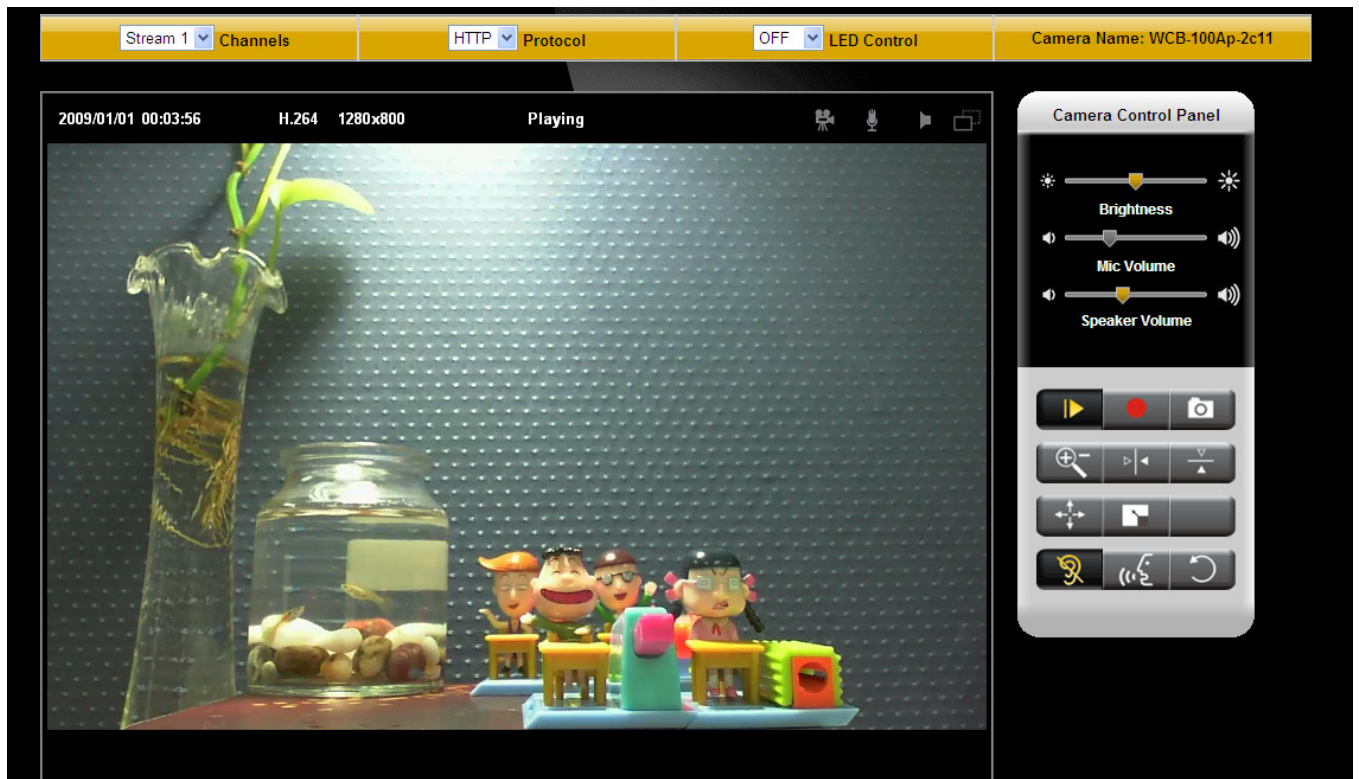

NOTE - (*) These are optional features. Please refer to the Product List for the full list of optional features available for the product.

Live View is the default page that opens when accessing the camera. Live video is displayed directly in the browser window.

- ***Stream1/Stream2 Channels***

The network camera offers simultaneous dual stream for optimized quality and bandwidth. Go to Configuration → Camera/Video/Audio → Video to configure the codec compression and video resolution or refer to the Video configuration page.

- ***HTTP/TCP/UDP protocol***

HTTP – This unicast method can be used to traverse firewalls. Firewalls are commonly configured to allow the HTTP protocol, thus allowing RTP to be tunneled.

TCP - This protocol guarantees the complete delivery of streaming data and provides better video quality. The downside of using this protocol is that the quality of its real-time effect is less than that of the UDP protocol.

UDP - This protocol allows for more real-time audio and video streams. However, network packets may be lost due to network burst traffic and images may be broken. Activate UDP connection time-sensitive responses are more important than video quality.

LED Control – Use the drop-down menu to adjust the brightness of the camera's LED.



Recording on/off - Displays the status of recording video



MIC on /off - Displays the status of the MIC volume



Speaker on/off - Displays the status of the Speaker

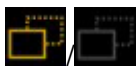

MD on/off - Displays the status of Motion Detection

- **Brightness** - Drag the slider bar to adjust the image brightness level.
- **Mic volume** - Drag the slider bar to adjust the microphone volume.
- **Speaker volume** - The built-in speaker will play sound from an audio clip from the computer microphone when it is enabled.

For more Audio settings, please refer to the Audio configuration page.



Playor Stop - Play or stop the video.



Recording - Record video to a computer.



Snapshot - Capture and save still images.

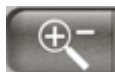

Digital Zoom - Enable the digital zoom operation.

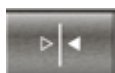

Mirror - Horizontally reflect the display of the live video.



Flip - Vertically reflect the display of the live video.



Real Size - View the object in real size. Press it again to switch back to normal

mode.



Full Screen - Switch to full screen mode. Press the “Esc” key to return to normal mode.

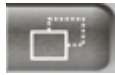

Motion Detection Alert - Enable the motion detection alert function.



Mute – Turn off the sound.



Talk(*) – To communicate through the camera using the computer MIC.



Set Default – Reset to default settings.



NOTE

1. The <Camera Control Panel> functions have no effect on the recorded video. Whatever changes are made to the <Camera Control Panel> **will not** be applied to the recorded video.
2. The LED is not for continuous use and has an estimated life span of 30,000 hours.
3. The LED cannot be replaced.

Configuration

Click <Configuration> on the main page to change the camera settings pages.



NOTE - Only Administrators can access the Configuration page.

Camera/Video/Audio

Camera

Name	Day
Brightness	<input type="range"/>
Contrast	<input type="range"/>
Sharpness	<input type="range"/>
Saturation	<input type="range"/>
Flicker Free	<input type="radio"/> 50Hz <input checked="" type="radio"/> 60Hz
Exposure Control	<input checked="" type="radio"/> Auto <input type="radio"/> Manual
Metering Option	<input type="radio"/> <input type="radio"/> <input type="radio"/> <input type="radio"/>
De-Noise	Level: Auto
Mirror and Flip	<input type="checkbox"/> Mirror <input type="checkbox"/> Flip
Color Effect	<input checked="" type="radio"/> Color <input type="radio"/> Black & White
White Balance	<input checked="" type="radio"/> Auto <input type="radio"/> 3000k <input type="radio"/> 5000k <input type="radio"/> 7000k
<input type="button" value="Test in Full Screen"/>	
<input type="button" value="Apply"/> <input type="button" value="Cancel"/>	

Profile – Up to five profiles can be created for different lighting environments. Day and night are default profiles and users can create up to three additional profiles. Select a profile from the drop-down menu or select different icons to change profile settings.

Name – Profile Name

Brightness - Drag the bar to adjust the image brightness level from -5 to +5.

Contrast - Drag the bar to adjust the image contrast level from -5 to +5.

Sharpness - Drag the bar to adjust the image sharpness level from -5 to +5.

Saturation - Drag the bar to adjust the image saturation level from -5 to +5.

Flicker-Free – Eliminates the problem of flicker.

Exposure Control

Auto: The camera will automatically control exposure.

Manual: Select this option to define the exposure manually

Mirror and Flip

Mirror - Enable to horizontally reflect the display of the live video.

Flip - Enable to vertically reflect the display of the live video.

De-Noise

Auto - The camera will automatically filter the frame-to-frame defects to reduce the visual impact of blur.

The De-noise can be set between 1 to 3, with 3 giving the best video resolution.

Color Effect - Select to display color or black and white video streams.

White Balance: White balance is a camera setting that adjusts for lighting in order to make white.

Profile Management: Profiles can be scheduled to change at scheduled times or under different lightening changes.

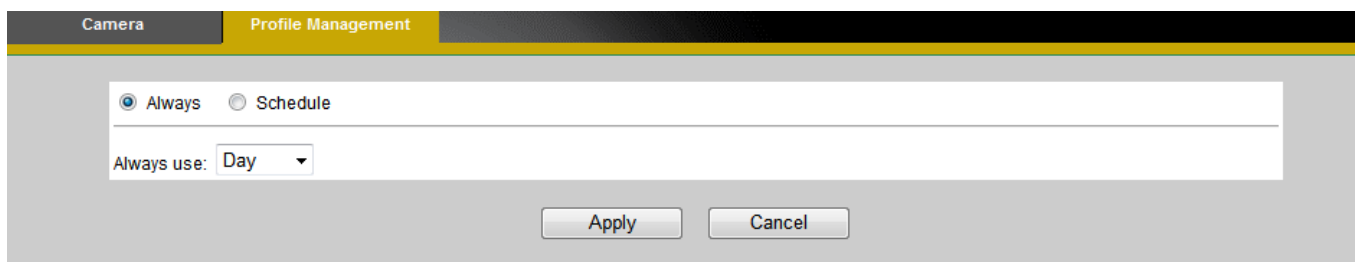

The screenshot shows the 'Profile Management' tab in a camera interface. At the top, there are two tabs: 'Camera' and 'Profile Management'. Below the tabs, there are two radio buttons: 'Always' (which is selected) and 'Schedule'. Below the radio buttons, there is a dropdown menu labeled 'Always use:' with 'Day' selected. At the bottom of the interface, there are two buttons: 'Apply' and 'Cancel'.

Always- Select Always to use a single profile. Select the profile from the drop down menu.

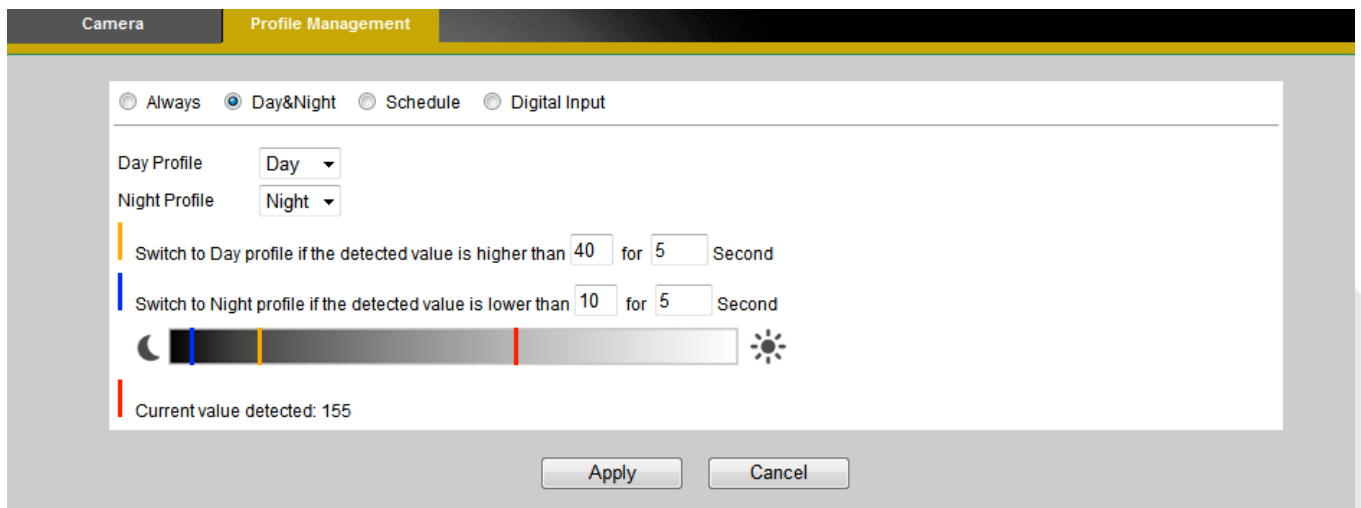

The screenshot shows the 'Profile Management' tab in a camera interface. At the top, there are four radio buttons: 'Always', 'Day&Night' (which is selected), 'Schedule', and 'Digital Input'. Below the radio buttons, there are two dropdown menus: 'Day Profile' with 'Day' selected and 'Night Profile' with 'Night' selected. Below the dropdown menus, there are two lines of text: 'Switch to Day profile if the detected value is higher than 40 for 5 Second' and 'Switch to Night profile if the detected value is lower than 10 for 5 Second'. Below the text, there is a horizontal slider with a moon icon on the left and a sun icon on the right. Below the slider, there is a text label: 'Current value detected: 155'. At the bottom of the interface, there are two buttons: 'Apply' and 'Cancel'.

Day & Night (Only available with models with a light sensor)- Select Day & Night to schedule two profiles for day and night. Select profiles from the drop down menu for the Day and Night Profiles.

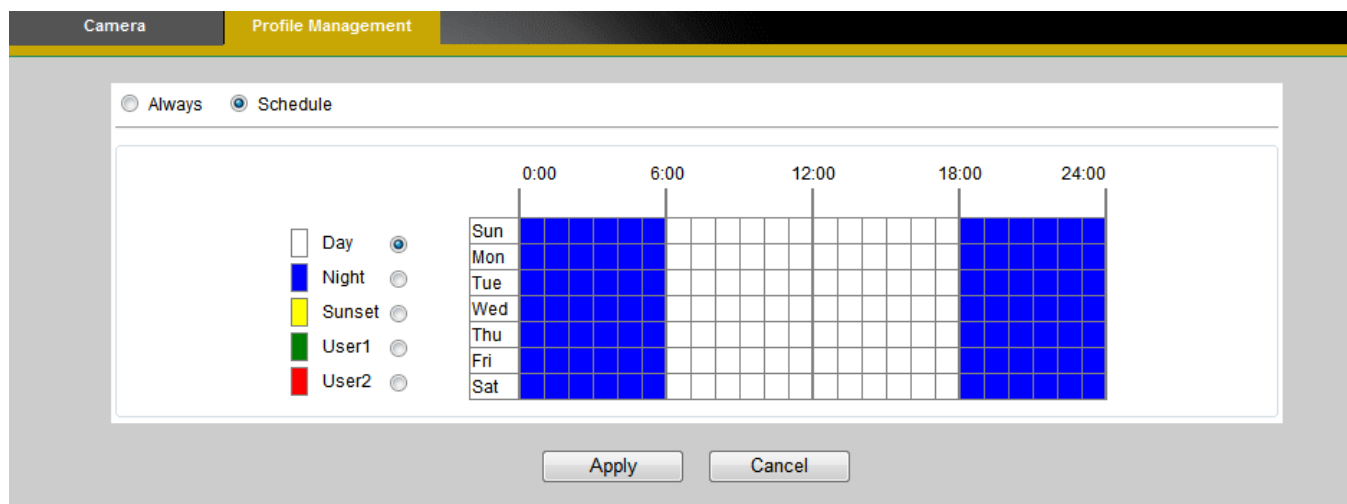

Schedule – Select Schedule to schedule specific time periods for different profiles.

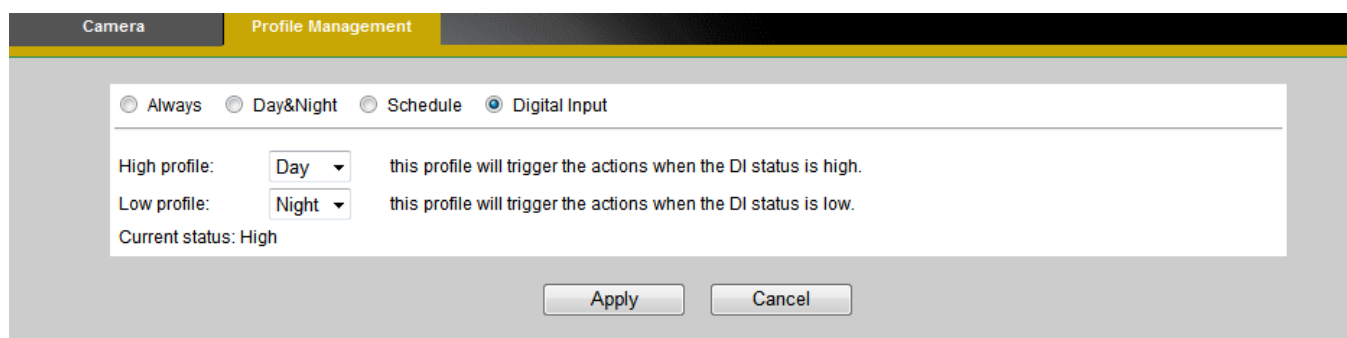

Digital Inputs (Only available with models with a DI terminal)- Select Digital Input to have the profile management controlled by an external sensor. Select profiles from the drop down menu. Profiles will change according to different trigger voltage levels.

Click **Apply** to apply settings or **Cancel** to cancel changes.

Video

The Network Camera offers two separate streams for different viewing options.

Stream		Video Overlay		RTSP Server		Save File Folder		Advanced Settings	
Aspect Ratio									
Mode	<input type="radio"/> 4:3 <input type="radio"/> 16:9 <input checked="" type="radio"/> 16:10								
Stream 1									
Video Codec	H.264								
Video Resolution	1280x800								
Frame Rate	25								
<input type="radio"/> Quality <input checked="" type="radio"/> Bitrate	4000 Kbps. (64~12000)								
GOP	0 (0~30,0:auto)								
Stream 2									
Enable	<input checked="" type="checkbox"/>								
Video Codec	MJPEG								
Video Resolution	1280x800								
Frame Rate	25								
<input checked="" type="radio"/> Quality	3								
Transport	<input type="radio"/> RTP <input type="radio"/> RTP with Quantization Table Header <input checked="" type="radio"/> HTTP Transport								
<small>Note: For stream recording, stream 1 must be set to H.264 or MPEG4 with a bitrate lower than 1.5Mbps or the quality below 3 and the resolution lower than 1280x1024.</small>									
Apply					Cancel				

Stream 1 & Stream 2

Aspect Ratio – Select the width to height image aspect ratio.

Video Codec - The Network Camera offers three choices of video codec standards for real-time viewing: H.264, MPEG-4 and MJPEG.

Video Resolution - Select from the drop-down menu to choose the best resolution recording settings.

Frame Rate - Select the frame rate from drop-down menu. When H.264 or MJPEG is selected, the frame rate ranges from 1 to 30 fps. When MPEG-4 is selected, the frame rate ranges from 1 to 15 fps. Set a higher frame rate for smoother video quality.

Video quality and bit rate - Choose either “quality” or “bitrate” to control the video quality with video codec at H.264 or MPEG4. Only “quality” can be chosen when video codec at MJPEG is selected. Set the bitrate higher for a better video quality.

Transport-

RTP: The Real-time Transport Protocol (RTP) defines a standardized packet format for delivering audio and video over IP networks.

RTP with Quantization Table Header : Choose this option to explicitly include JPEG quantization table in the RTP stream [RFC 2435, section 3.1.8].

HTTP Transport: If MJPEG is used for Video Codec, HTTP Transport protocol must be enabled to remotely access the video stream.



NOTE - a higher bitrate will use higher network bandwidth. The video quality can be set between Level 1 to Level 6, with Level 6 producing the best image quality.

HTTP Transport – If MJPEG is used for Video Codec, users can enable HTTP Transport protocol for video communication.



NOTE – HTTP Transport is for non-IE browser used only.

Click **Apply** to apply settings or **Cancel** to cancel changes.

Video Overlay

Stream	Video Overlay	RTSP Server	Save File Folder	Advanced Settings
Timestamp				
Enable	<input type="checkbox"/>			
Position	Left-Top			
Text				
Enable	<input type="checkbox"/>			
Position	Left-Top			
Text	<input type="text"/>			

The video overlay will only take effect in stream 1

Timestamp

To display the date and time on the screen during live view, check “Enable” to enable the timestamp function and select the display position from the drop-down menu.

Text

To make a note about the camera, check “Enable” and select the display position from the drop-down menu. Enter a video description in the text box.

Click **Apply** to apply settings or **Cancel** to cancel changes.



NOTE - The video overlay will only takes effect in stream 1.

RTSP Server

Stream	Video Overlay	RTSP Server	Save File Folder	Advanced Settings
RTSP Server				
Port	554			
Authentication	NONE			
RTP/RTCP				
RTCP Mode	Without SR			
Apply		Cancel		

To utilize RTSP authentication, the user must first set a password for the camera. RTSP (Real-Time Streaming Protocol) controls the delivery of streaming media. By default the port number is set to 554.

Authentication - Depending on the network security requirements, the camera provides two types of security settings for streaming via RTSP protocol: NONE and DIGEST.

If DIGEST authentication is selected, user credentials are encrypted using MD5 algorithm, thus providing better protection against unauthorized access.

RTCP/RTCP-

RTCP without SR - RTCP without SR (Sender Report) is the default option. Under this option, audio and video received from the IP camera are played immediately and independent of each other.

RTCP with SR - RTCP with SR option allows synchronization between video and audio on live viewing. Choose this option if audio and video become unsynchronized.

Click Apply to apply settings or Cancel to cancel changes.

Save File Folder

Stream	Video Overlay	RTSP Server	Save File Folder	Advanced Settings
Recording Folder Path				
Path	C:\Users\Mars\Documents\Brickcom			Browse...
Snapshot Folder Path				
Path	C:\Users\Mars\Documents\Brickcom			Browse...
Type	JPEG			
These settings are used for Recording and Snapshot functions in the Live View page.				
Apply		Cancel		

Recording folder path - The destination for saving the recording video files. Click Browse to specify the saving path.

Snapshot folder path - The destination for saving the snapshot files. Click Browse to specify the saving path and select the format from the drop-down menu.

Advanced Settings

The screenshot shows a web interface with a navigation bar at the top containing tabs for 'Stream', 'Video Overlay', 'RTSP Server', 'Save File Folder', 'Advanced Settings', and a black tab. The 'Advanced Settings' tab is active. Below the navigation bar, there are two main sections. The first section is titled 'Video usability information (VUI)' and contains an 'Enable' checkbox which is checked. The second section is titled 'Sequence Parameter Set (SPS) & Picture Parameter Set (PPS)' and also contains an 'Enable' checkbox which is checked. At the bottom of the settings area, there are two buttons: 'Apply' and 'Cancel'.

Video usability information (VUI)- Enable this feature to insert extra information into the bit stream to enhance the use of the video for a wide variety of purposes.

Sequence Parameter Set (SPS) & Picture Parameter Set (PPS)-

Enable or disable SPS and PPS in the H.264 packet. Sequence parameter sets (SPS), which apply to a series of consecutive coded video pictures called a coded video sequence, and Picture parameter sets (PPS), which apply to the decoding of one or more individual pictures within a coded video sequence.

Click **Apply** to apply settings or **Cancel** to cancel changes.

Audio

The administrator can set up two separate streams for the camera for different viewing devices. The administrator can enable or disable the audio function on either stream. If audio enable is selected, select the Audio codec from the drop-down menu.

The screenshot shows the 'Stream' tab with 'Advanced Settings' selected. It contains two sections: 'Stream 1' and 'Stream 2'. Each section has an 'Enabled' checkbox (unchecked) and an 'Audio Codec' dropdown menu set to 'G.711'. At the bottom are 'Apply' and 'Cancel' buttons.

Advanced Settings

The screenshot shows the 'Advanced Settings' section. It contains two sections: 'Camera Speaker' and 'Echo Cancellation'. 'Camera Speaker' has an 'Enabled' checkbox checked and a 'Volume' dropdown set to '50%'. 'Echo Cancellation' has an 'Enabled' checkbox unchecked. At the bottom are 'Apply' and 'Cancel' buttons.

Camera Speaker – If the speaker is enabled, select the volume from the drop-down menu.

Echo Cancellation Enabled - Enable to avoid an echo.

Click **Apply** to apply settings or **Cancel** to cancel changes.

Multicast

The screenshot shows the 'Multicast' tab. It contains two sections: 'Stream 1' and 'Stream 2'. Each section has an 'Enabled' checkbox (unchecked), a 'Multicast Address' field with four sub-inputs (234, 1, 2, 3), and a 'Port' field (10000 for Stream 1, 20000 for Stream 2). At the bottom are 'Apply' and 'Cancel' buttons.

Multicast sends a video stream to the multicast group address and allows multiple clients to acquire the stream at the same time by requesting a copy from the multicast group address. Therefore, multicast can effectively save Internet bandwidth. The RTSP (Real-Time Streaming

Protocol) controls the delivery of streaming media.

Click “Enable” to enable Multicast stream 1 or Multicast stream 2. The default value for multicast address and port are 234.1.2.3 and 10000. Use different port number for different streams. It is recommended to use the default values.



NOTE - Using the IP address of the Network Camera enables access to the video.

Example: `rtsp://192.168.1.1/channel1`

Click **Apply** to apply settings or **Cancel** to cancel changes.

Privacy Mask Control

The Cube camera is equipped with a privacy feature which allows users to mask the camera’s live view. A black screen will be displayed in place of the live view window. This application is particularly useful when the camera is being used for home surveillance. With the privacy button, the user can have privacy while they are going about their daily life.

Privacy Mask Control	
Enabled	<input type="checkbox"/>

Hardware Privacy Mask Button	
Enabled	<input checked="" type="checkbox"/>

Apply Cancel

Privacy Mask Control – Enable the Privacy Mask control to remotely mask the camera’s live view.

Hardware Privacy Mask Button – Click to enable the privacy mask button on the camera. If this feature is not enabled, the user will not be able to use the privacy mask button.

Click **Apply** to apply settings or **Cancel** to cancel changes.

Network

IP Settings

This section explains how to configure a wired network connection for the camera. There are several ways to setup the camera over the Internet: (1) obtain an available dynamic IP address assigned by a DHCP server, (2) use a static IP, or use PPPoE (Point-to-point over Ethernet). Select the desire setup mode from the IP settings drop-down menu.

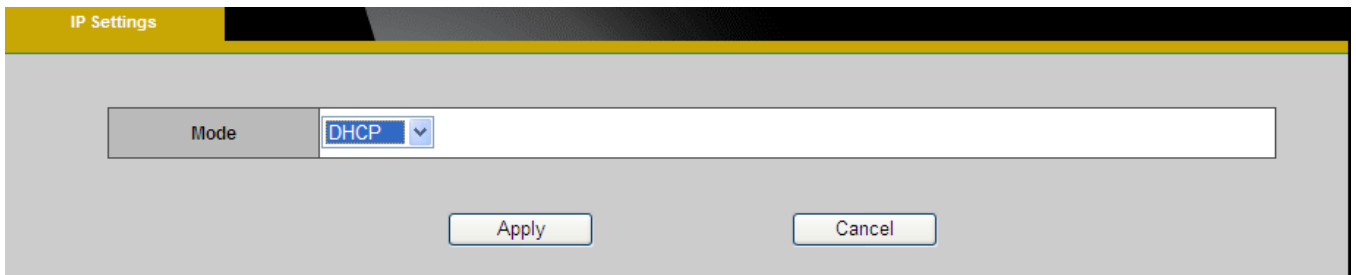

The screenshot shows the 'IP Settings' window with the 'Mode' dropdown menu set to 'DHCP'. Below the dropdown are two buttons: 'Apply' and 'Cancel'.

1. **DHCP** –If this option is selected, the camera will automatically obtain an available dynamic IP address from the DHCP server each time it connects to the LAN.

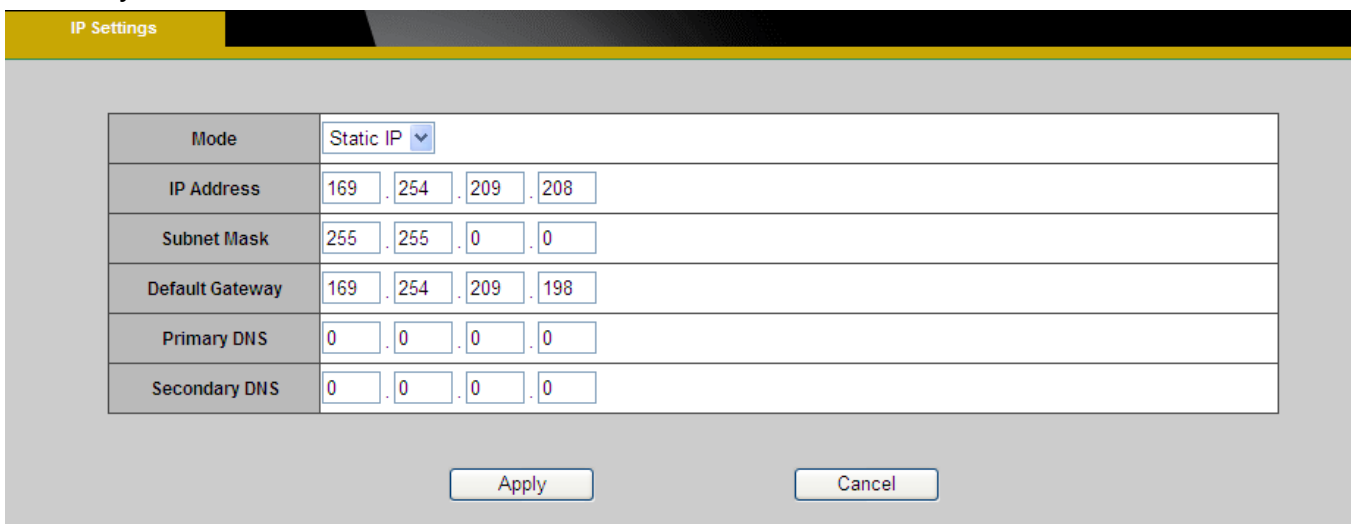

The screenshot shows the 'IP Settings' window with the 'Mode' dropdown menu set to 'Static IP'. Below the dropdown is a table for configuring static IP settings. At the bottom are 'Apply' and 'Cancel' buttons.

Mode	Static IP			
IP Address	169	254	209	208
Subnet Mask	255	255	0	0
Default Gateway	169	254	209	198
Primary DNS	0	0	0	0
Secondary DNS	0	0	0	0

2. **Static IP** - Select this option to manually assign a static IP address to the camera. Enter the static IP address, Subnet mask, Default Gateway, Primary and Secondary DNS provided by the ISP.

The screenshot shows the 'IP Settings' configuration page. The 'Mode' dropdown menu is set to 'PPPoE'. Below it are input fields for 'Username' and 'Password'. At the bottom of the form are 'Apply' and 'Cancel' buttons.

3. **PPPoE** (Point-to-point over Ethernet): Use this mode if connecting to the Internet through a DSL Line.  **NOTE** - To utilize this feature, it requires an account provided by an Internet Service Provider. Enter the user name and password provided by the ISP. Click **Apply** to apply settings or **Cancel** to cancel changes.
4. **3G(*)** – Use this option if using a 3G SIM card to transmit video/audio surveillance over a 3G network

The screenshot shows the 'IP Settings' configuration page with 'Mode' set to '3G'. The form includes input fields for 'APN' (containing 'internet'), 'Dial Number' (containing '*99#'), 'PIN Code' (containing '0000'), 'Username', and 'Password'. 'Apply' and 'Cancel' buttons are at the bottom.

 **NOTE** - This function is only available for GOB models.

- a. Enter the APN (Access Point Number), Dial Number, PIN Code, User Name and Password provided by the ISP.
- b. Click **Apply** to apply the settings. The message below will be displayed if the 3G settings were successfully applied.

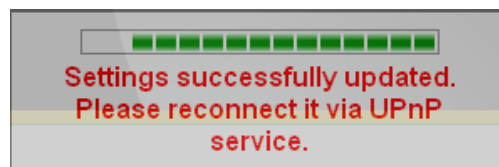

- c. Before disconnected the wired connection with the network camera, obtain the IP Address by opening EasyConfig. The 3G connection IP Address will be displayed in the IP Address column.



d. The network camera can now be accessed over a 3G network. To access the video feed through the internet, open a web browser and enter the network camera's IP address. A dialog window will pop up requesting a username and password. As stated on the previous page, the default username and password for the Administrator account are "admin/admin".

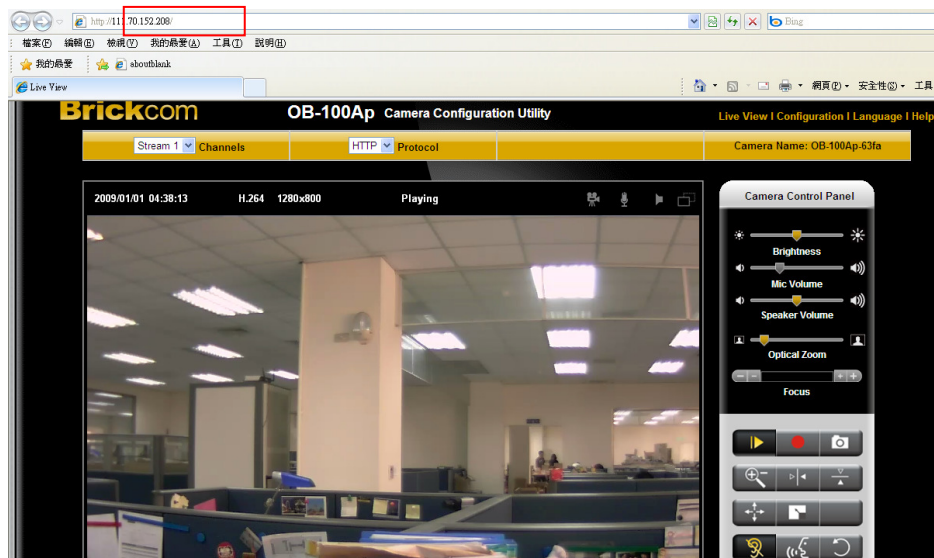

UPnP

Universal Plug and Play (UPnP) simplifies the process of adding a camera to a local area network. Once connected to a LAN, the camera will automatically appear on the intranet. Click "Enable" to enable this function and enter an UPnP name which the camera will appear under on the intranet.

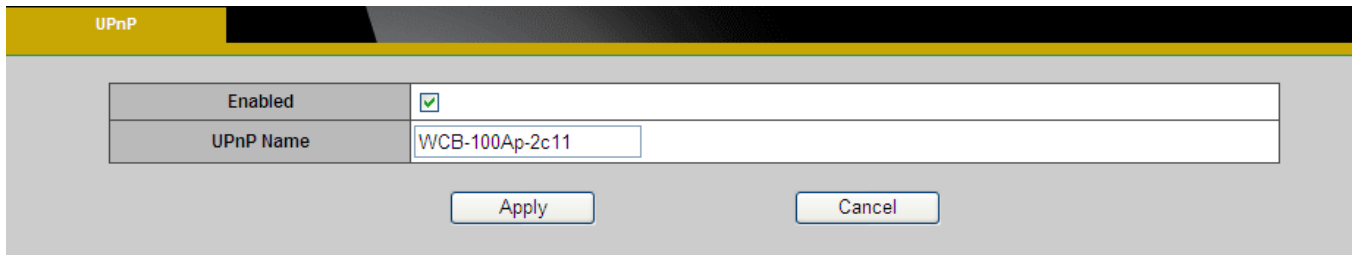

The image shows a configuration window for UPnP. At the top, there is a yellow header with the text "UPnP". Below this, there is a table with two rows: "Enabled" with a checked checkbox and "UPnP Name" with a text box containing "WCB-100Ap-2c11". At the bottom of the window, there are two buttons: "Apply" and "Cancel".

Click **Apply** to apply settings or **Cancel** to cancel changes.

DDNS (dynamic domain name service)

DDNS links a domain name to an IP address, allowing users to easily access their camera even with a changing IP address. Brickcom network cameras are compatible with three DDNS

service providers (1) DynDNS, (2) TZO, and (3) No-IP.  **NOTE** - Before utilizing this function; please apply for a dynamic domain account from a DDNS provider.

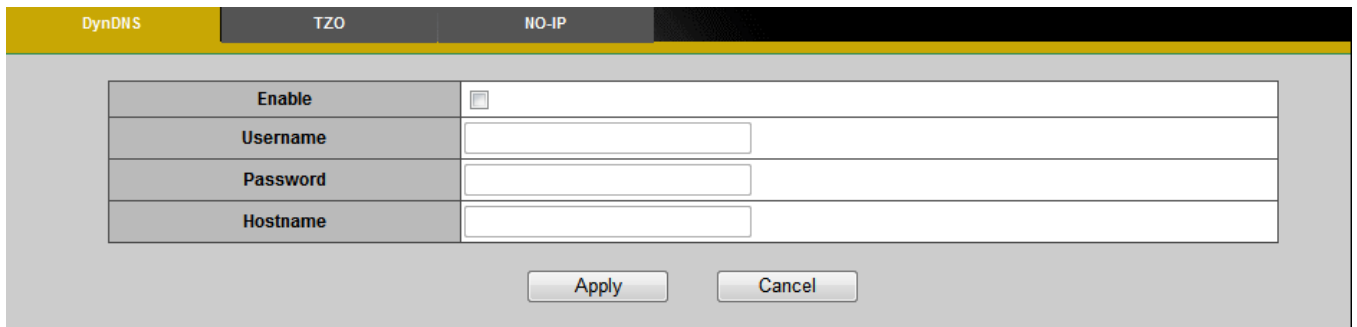

The image shows a configuration window for DynDNS. At the top, there is a yellow header with three tabs: "DynDNS", "TZO", and "NO-IP". The "DynDNS" tab is selected. Below this, there is a table with four rows: "Enable" with an unchecked checkbox, "Username" with a text box, "Password" with a text box, and "Hostname" with a text box. At the bottom of the window, there are two buttons: "Apply" and "Cancel".

DynDNS – Enable the DynDNS to allow the camera to have a fixed host and domain name. Refer to the DynDNS website (www.dyndns.com) to apply for a dynamic domain account. When an account has been created, enter the username, password and hostname.

Click **Apply** to apply settings or **Cancel** to cancel changes.

TZO

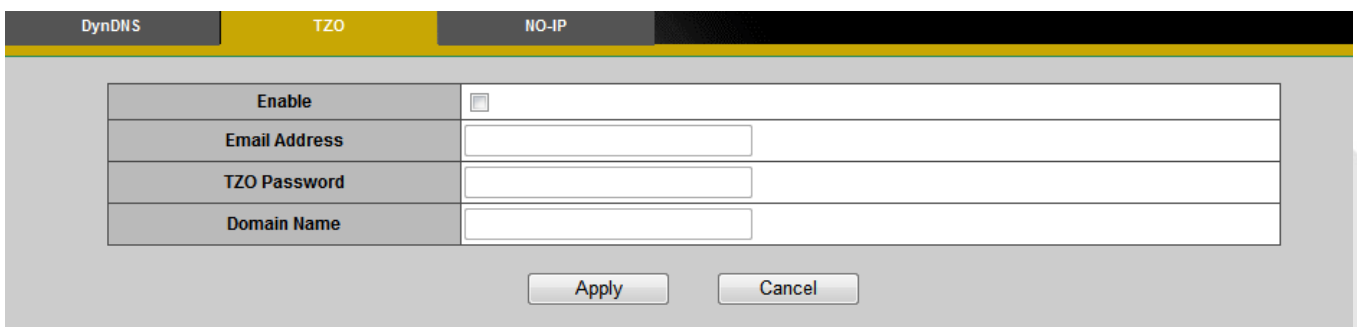

The image shows a configuration window for TZO. At the top, there is a yellow header with three tabs: "DynDNS", "TZO", and "NO-IP". The "TZO" tab is selected. Below this, there is a table with four rows: "Enable" with an unchecked checkbox, "Email Address" with a text box, "TZO Password" with a text box, and "Domain Name" with a text box. At the bottom of the window, there are two buttons: "Apply" and "Cancel".

TZO is a DDNS provider which allows users to create a dynamic DNS. Refer to the TZO website (<http://www.tzo.com/>) to apply for a dynamic domain account. When an account has been created, enter the e-mail address, password and domain name.

Click **Apply** to apply settings or **Cancel** to cancel changes.

No-IP

DynDNS	TZO	NO-IP	
Enable	<input type="checkbox"/>		
Email Address	<input type="text"/>		
Password	<input type="text"/>		
Hostname	<input type="text"/>		
<input type="button" value="Apply"/> <input type="button" value="Cancel"/>			

No-IP is a DDNS provider which offers DNS services, email, network monitoring and SSL certificates. Email services include POP3 email, outbound SMTP email, backup mail services and mail reflection and filtering. Refer to the No-IP website (www.no-ip.com) to apply for a dynamic domain account. When an account has been created, enter the e-mail address, password and domain name.

Click **Apply** to apply settings or **Cancel** to cancel changes.

EasyLink™

EasyLink™ is a unique Brickcom function which allows users to assign a unique EasyLink name to their network camera's IP address. There is no need to configure the router to open up ports or remember hard-to-memorize IP addresses. When this function is enabled, users can log onto [uniqueEasyLinkname].mybrickcom.com to view the camera's web GUI and live view.

1. Check the box to enable EasyLink™.
2. If Auto mode is selected, the following page will be displayed.  **NOTE** - This mode is recommended.
3. Enter a unique EasyLink name whose length must be between 5-32 characters. Verify that the EasyLink name is available.

EasyLink	
Enable	<input checked="" type="checkbox"/>
Mode	<input checked="" type="radio"/> Auto <input type="radio"/> Manual
EasyLink Name	<input type="text" value="00402512aabb"/> .mybrickcom.com <input type="button" value="Verify"/>
EasyLink Status	The EasyLink function cannot work because the IP camera is behind a Double NAT network.
<input type="button" value="Apply"/> <input type="button" value="Cancel"/>	

4. If Manual mode is selected, the following page will be displayed.
 - a. Manually enter the Public IP Address, HTTP port and RTSP port or leave the default values.

Enable	<input checked="" type="checkbox"/>
Mode	<input type="radio"/> Auto <input checked="" type="radio"/> Manual
EasyLink Name	00402512aabb .mybrickcom.com <input type="button" value="Verify"/>
Public IP Address	0 . 0 . 0 . 0
Public HTTP port	80
Public RTSP port	554
EasyLink Status	The EasyLink function cannot work because the IP camera is behind a Double NAT network.

Click **Apply** to apply settings or **Cancel** to cancel changes.



NOTE - The EasyLink function will not work if the following conditions occur:

1. The camera cannot be located behind a double NAT network.
2. The camera's IP address cannot be assigned to specific port numbers using the router's port forwarding.
3. EasyLink uses UPnP to exchange port information with the router. The camera must connect to the internet through a router which supports UPnP.

Wireless

These settings control how a Network Camera interacts with a wireless network. Users can identify the wireless network and enable wireless encryption.

 **NOTE** – This function is only available for WCB models.

Basic Settings

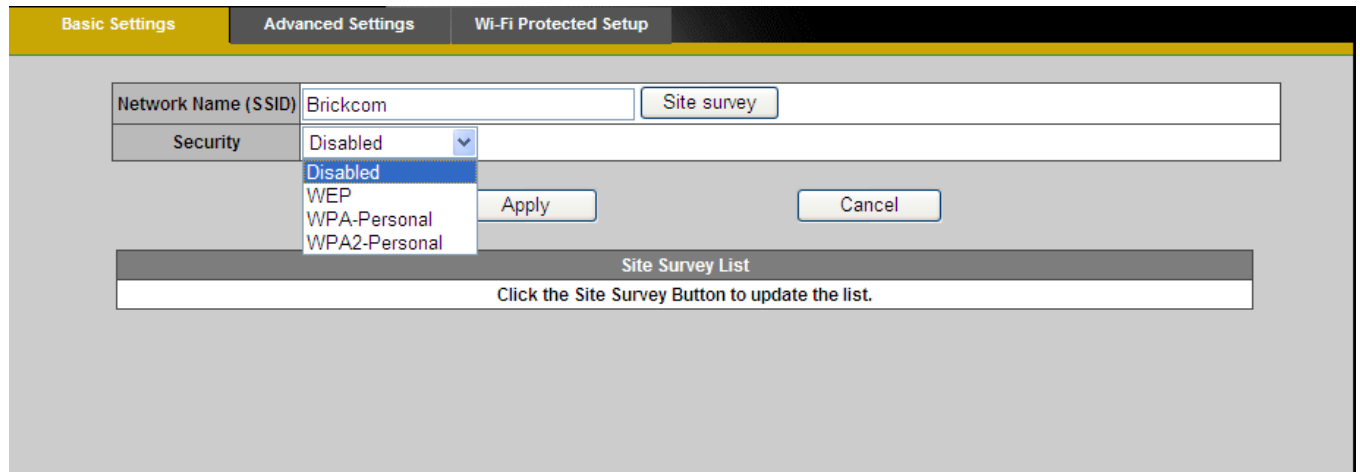

Network Name (SSID) - The Service Set Identifier (SSID) is the network name used to identify the wireless signal emitted from a wireless camera. It is case-sensitive and can be up to 32 characters long.

Wireless devices have a default SSID set by the factory. Brickcom wireless products use **Brickcom** as the default name. It is recommended for users to rename their SSID to something unique in order to distinguish their wireless device from surrounding wireless networks.

 **NOTE** - Be careful when including personal information when naming the SSID as it is viewable by anyone browsing for wireless networks.

Security - Encryption protects data transmitted over a wireless network. Wi-Fi Protected Access (WPA-Personal/WPA2-personal) and Wired Equivalent Privacy (WEP) offer different levels of security for wireless communication. A network encrypted with WPA-Personal/WPA2-personal is more secure than a network encrypted with WEP because WPA-Personal/WPA2-personal uses dynamic key encryption. To protect the information as it passes through the airwaves, it is recommended to enable the highest level of encryption supported by the network equipment.

Site Survey – Survey the local area for available wireless networks. The user should select their Local Area Network (LAN) from the Site Survey List.

The screenshot shows the 'Wi-Fi Protected Setup' configuration page. At the top, there are three tabs: 'Basic Settings', 'Advanced Settings', and 'Wi-Fi Protected Setup'. The 'Network Name (SSID)' field contains 'Brickcom' and the 'Security' dropdown is set to 'Disabled'. Below these fields are 'Apply' and 'Cancel' buttons. The main section is titled 'Site Survey List' and contains a table with the following data:

SSID	Mode	Security	Channel	Signal	Type	Select
test_gary_Brickcom_1	11b/g/n	NONE	1	78%	Infrastructure	Select
SmartHub-AWRT600N	11b/g/n	NONE	1	73%	Infrastructure	Select
Test-FAE	11b/g/n	NONE	1	100%	Infrastructure	Select
bricom_3	11b/g/n	NONE	1	89%	Infrastructure	Select
Test_Cavin	11b/g	NONE	1	57%	Infrastructure	Select
PC-NVR-TEST	11b/g/n	NONE	2	68%	Infrastructure	Select

WEP- Wired Equivalent Privacy (WEP) is a basic encryption method which transmits network broadcast messages using radio signals. It is not as secure as WPA.

Basic Settings
Advanced Settings
Wi-Fi Protected Setup

Network Name (SSID)	<input type="text" value="Brickcom"/>	<input type="button" value="Site survey"/>
Security	<input type="text" value="WEP"/>	
TX Key	<input type="text" value="1"/>	
WEP Encryption	<input type="text" value="40/64 bits (10 hex digits)"/>	
Key 1	<input type="text"/>	
Key 2	<input type="text"/>	
Key 3	<input type="text"/>	
Key 4	<input type="text"/>	
Authentication	<input type="text" value="Open System"/>	

Site Survey List						
SSID	Mode	Security	Channel	Signal	Type	Select
test_gary_Brickcom_1	11b/g/n	NONE	1	78%	Infrastructure	<input type="button" value="Select"/>
SmartHub-AWRT600N	11b/g/n	NONE	1	73%	Infrastructure	<input type="button" value="Select"/>
Test-FAE	11b/g/n	NONE	1	100%	Infrastructure	<input type="button" value="Select"/>
bricom_3	11b/g/n	NONE	1	89%	Infrastructure	<input type="button" value="Select"/>
Test_Cavin	11b/g	NONE	1	57%	Infrastructure	<input type="button" value="Select"/>
PC-MBP-TEST	11b/g/n	NONE	2	88%	Infrastructure	<input type="button" value="Select"/>

Tx Key - Select a key from the drop-down menu.

WEP Encryption - Select a level of WEP encryption: 64 bits 10 hex digits or 128 bits 26 hex digits. The default is 64 bits 10 hex digits.

Key 1-4 - Enter the WEP key(s) manually.

Authentication - The default is set to Open System, which allows either Shared Key or Auto authentication to be used. With Shared Key authentication, the sender and recipient use a WEP key for authentication. With Auto authentication, the sender and the recipient do not use a WEP key for authentication.

Click **Apply** to apply settings or **Cancel** to cancel changes.

WPA-Personal - WiFi Protected Access (WPA)-Personal

Basic Settings Advanced Settings **Wi-Fi Protected Setup**

Network Name (SSID)	<input type="text" value="Brickcom"/> <input type="button" value="Site survey"/>
Security	<input type="text" value="WPA-Personal"/>
Encryption	<input type="text" value="TKIP"/>
Shared Key	<input type="text"/> (8 to 63 characters)

Site Survey List						
SSID	Mode	Security	Channel	Signal	Type	Select
test_gary_Brickcom_1	11b/g/n	NONE	1	78%	Infrastructure	<input type="button" value="Select"/>
SmartHub-AWRT600N	11b/g/n	NONE	1	73%	Infrastructure	<input type="button" value="Select"/>
Test-FAE	11b/g/n	NONE	1	100%	Infrastructure	<input type="button" value="Select"/>
bricom_3	11b/g/n	NONE	1	89%	Infrastructure	<input type="button" value="Select"/>
Test_Cavin	11b/g	NONE	1	57%	Infrastructure	<input type="button" value="Select"/>
PC-NVR-TEST	11b/g/n	NONE	2	68%	Infrastructure	<input type="button" value="Select"/>

Encryption - Supports two encryption methods with dynamic encryption keys: Temporal Key Integrity Protocol (TKIP) and Advanced Encryption Standard (AES). Select the algorithm type from the drop down menu: TKIP or AES. The default is TKIP.

Shared Key - Enter the key shared between the Router and the server keys. Enter a password of 8-63 characters.

Click **Apply** to apply settings or **Cancel** to cancel changes.

WPA2-Persona I - WiFi Protected Access (WPA2-Personal)

Basic Settings | **Advanced Settings** | Wi-Fi Protected Setup

Network Name (SSID)	<input type="text" value="Brickcom"/> <input type="button" value="Site survey"/>
Security	<input type="text" value="WPA2-Personal"/>
Encryption	<input type="text" value="AES"/>
Shared Key	<input type="text"/> (8 to 63 characters)

Site Survey List						
SSID	Mode	Security	Channel	Signal	Type	Select
test_gary_Brickcom_1	11b/g/n	NONE	1	78%	Infrastructure	<input type="button" value="Select"/>
SmartHub-AWRT600N	11b/g/n	NONE	1	73%	Infrastructure	<input type="button" value="Select"/>
Test-FAE	11b/g/n	NONE	1	100%	Infrastructure	<input type="button" value="Select"/>
bricom_3	11b/g/n	NONE	1	89%	Infrastructure	<input type="button" value="Select"/>
Test_Cavin	11b/g	NONE	1	57%	Infrastructure	<input type="button" value="Select"/>
PC-NVP-TEST	11b/g/n	NONE	2	68%	Infrastructure	<input type="button" value="Select"/>

Encryption - WPA2 supports AES encryption method with dynamic encryption keys.

Shared Key - Enter the key shared between the Router and the server keys. Enter a password of 8-63 characters.



NOTE - If using WPA or WPA2, each device in the wireless network must use the same WPA or WPA2 method and shared key or else the network will not function properly.

Advanced Settings

Basic Settings	Advanced Settings	Wi-Fi Protected Setup
Network Mode	BGN-Mixed	
Radio Band	Auto-20/40MHz Channel	
WMM (802.1e QoS)	Disabled	

Network Mode - From the drop-down menu, select the wireless standards running on the network.

- If there are Wireless-B, Wireless-G and Wireless-N (2.4GHz) devices on the network, use the default setting, **BGN-Mixed**.
- If there are Wireless-B and Wireless-G devices on the network, select **BG-Mixed**.
- If there are only Wireless-B devices on the network, select **Wireless-B Only**.
- If there are only Wireless-G devices on the network, select **Wireless-G Only**.
- If there are only Wireless-N (2.4GHz) devices on the network, select **Wireless-N Only**.
- (*) If there are Wireless-A and Wireless-N devices on the network, select **AN-Mixed**.
- (*) If there are Wireless-A, Wireless-B, Wireless-G and Wireless-N (2.4GHz) devices on the network, use the default setting, **ABGN-Mixed**.
- (*) If there are only Wireless-A devices on the network, select **Wireless-A Only**.

Radio Band - The settings are available for the Auto-20/40MHz channel and Standard-20 MHz channel.

Enable WMM (802.1e QoS) - WMM is a wireless Quality of Service feature that improves quality for audio, video, and voice applications by prioritizing wireless traffic. To use this feature, the wireless client devices on the network must support Wireless WMM. The default setting is **Enabled**. To disable this feature, select **Disable**.

Click **Apply** to apply settings or **Cancel** to cancel changes

Wi-Fi Protected Setup

Basic Settings		Advanced Settings		Wi-Fi Protected Setup	
Wi-Fi Protected Setup					
PIN Mode		Enter PIN number 38989827 in the AP device			
		Enter the AP's SSID <input type="text" value="Brickcom"/>			
		Click the Register button on the right to start WPS. <input type="button" value="Register"/>			
Wi-Fi Protected Setup Status		Not Configured			
Hardware WPS Button					
Enabled		<input checked="" type="checkbox"/>			
<input type="button" value="Apply"/>			<input type="button" value="Cancel"/>		

Use this method if the client device has a Wi-Fi Protected Setup PIN number.

1. Enter the network name from the device in the field.
2. Click <Register> to start WPS.
3. Click "Enable" to enable the WPS Button. If this feature is not enabled, the user will not be able to use the WPS button

Click **Apply** to apply settings or **Cancel** to cancel changes.

HTTP/HTTPS

HTTP/HTTPS	
HTTP	
Enabled	<input checked="" type="checkbox"/>
Port	<input type="text" value="80"/>
HTTPS	
Enabled	<input type="checkbox"/>
Port	<input type="text" value="443"/>
<input type="button" value="Apply"/> <input type="button" value="Cancel"/>	

HTTP – (HyperText Transfer Protocol) - This protocol allows for TCP protocol quality without having to open specific ports for streaming. Users inside a firewall can utilize this protocol to allow streaming data through.

HTTPS - (Hypertext Transfer Protocol over SSL) - This protocol allows authentication and encrypted communication over SSL (Secure Socket Layer). It helps protect streaming data transmission over the Internet on a higher security level than HTTP.

Click "Enable" to enable and **Apply** to apply settings or **Cancel** to cancel changes.

To enable HTTPS, users have to create and install a certificate.

1. Click "Continue to this website" to install.

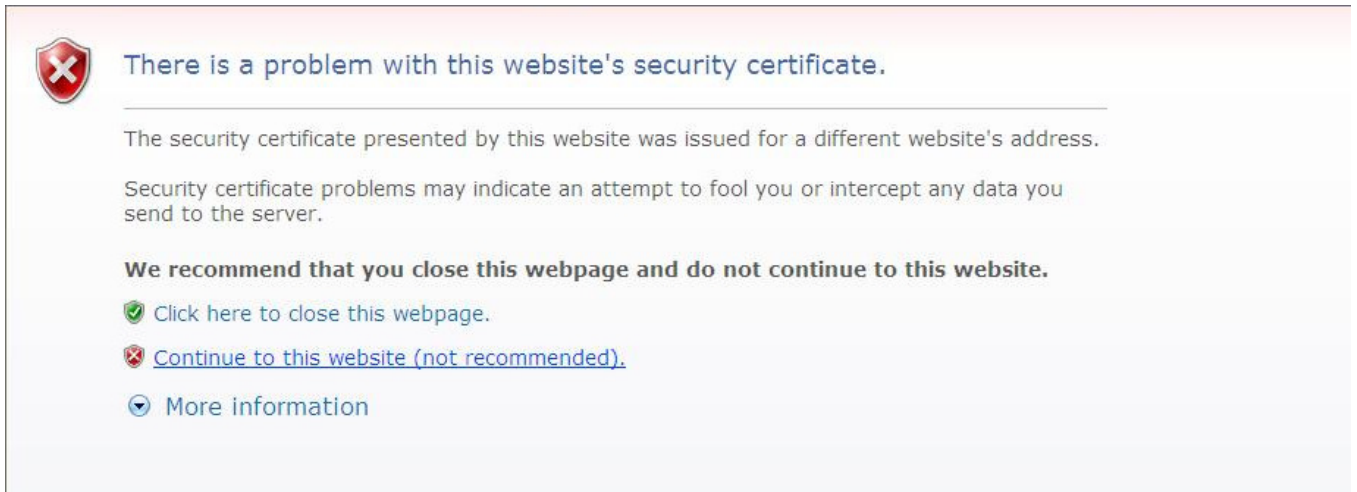

2. Enter the User name and Password of the camera.

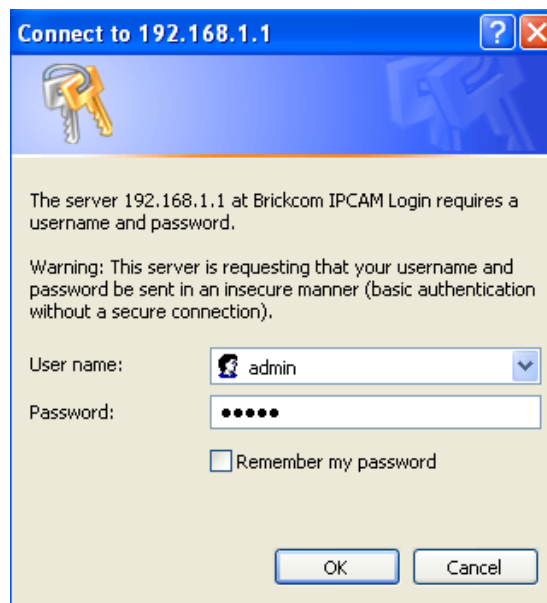

3. Click “Certificate Error” on the top right corner of the window to view the certificate.

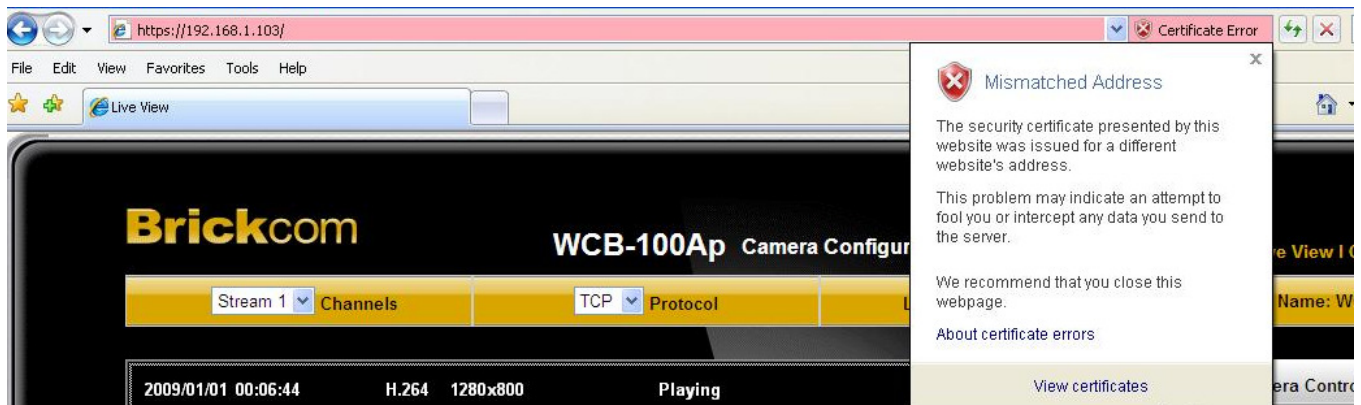

4. Click “Install Certificate” and follow the steps to finish the installation.

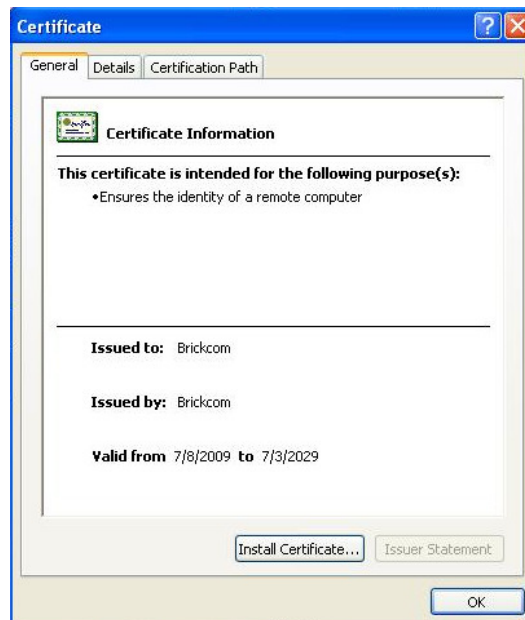

Event

Event Settings

When an event (such as unauthorized movement) occurs, the camera can be scheduled to perform certain actions. An Event Type is a set of parameters that defines these actions. This section describes how to configure the camera to perform certain actions when events occur.

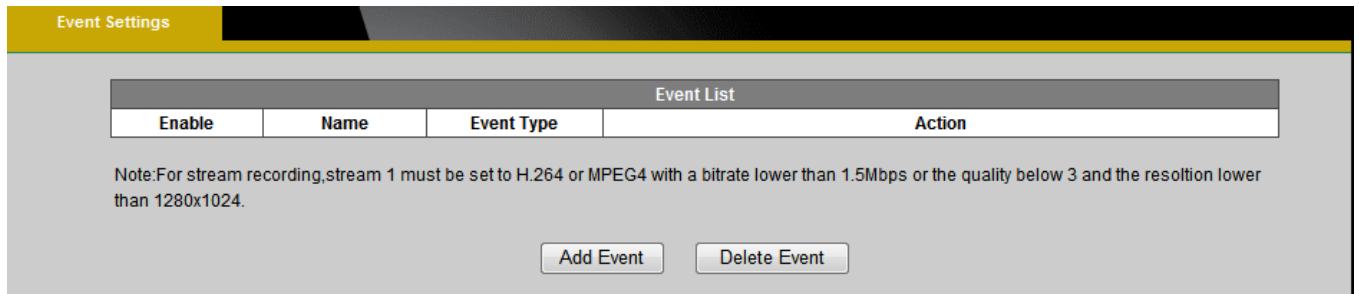

Click <Add Event> on the Event Settings page. The Event Setup page will appear.

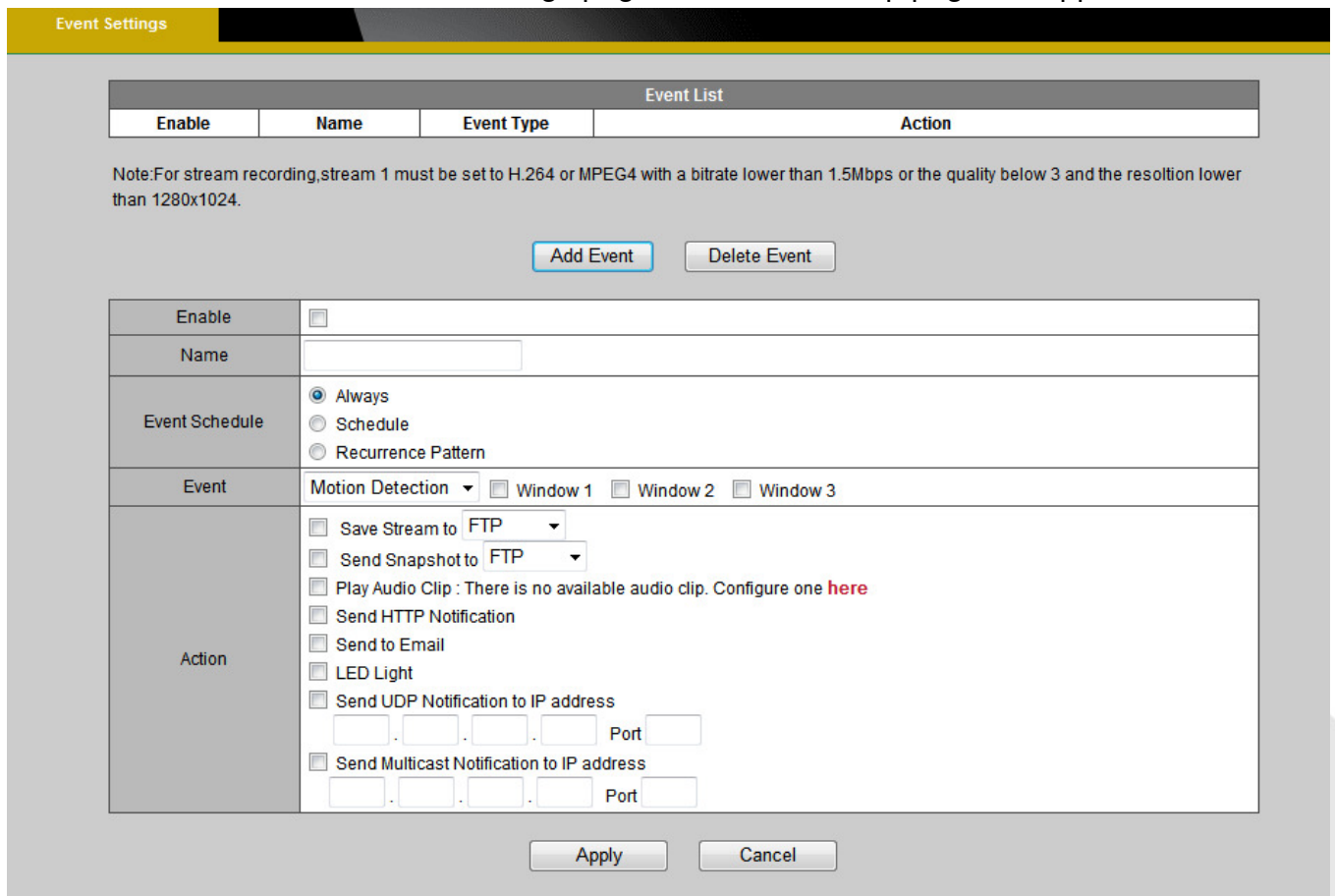

How to Set Up an Event Schedule

Event Schedule describes how and when the camera performs certain actions.

1. Check "Enable" and enter a descriptive name for the event schedule.

2. Set Event Schedule to define when the event is activated by selecting from Always (24 hours), Schedule or Recurrence pattern.
 - a. If Schedule is selected from the Event Schedule, the following page will be displayed:

Enable	<input type="checkbox"/>																																															
Name	<input type="text"/>																																															
Event Schedule	<input type="radio"/> Always <input checked="" type="radio"/> Schedule																																															
	<table border="1"> <tr> <td></td> <td>0:00</td> <td>6:00</td> <td>12:00</td> <td>18:00</td> <td>24:00</td> </tr> <tr> <td>Sun</td> <td></td> <td></td> <td></td> <td></td> <td></td> </tr> <tr> <td>Mon</td> <td></td> <td></td> <td></td> <td></td> <td></td> </tr> <tr> <td>Tue</td> <td></td> <td></td> <td></td> <td></td> <td></td> </tr> <tr> <td>Wed</td> <td></td> <td></td> <td></td> <td></td> <td></td> </tr> <tr> <td>Thu</td> <td></td> <td></td> <td></td> <td></td> <td></td> </tr> <tr> <td>Fri</td> <td></td> <td></td> <td></td> <td></td> <td></td> </tr> <tr> <td>Sat</td> <td></td> <td></td> <td></td> <td></td> <td></td> </tr> </table> <p> <input checked="" type="checkbox"/> Event Schedule <input type="checkbox"/> Not Scheduled </p> <p> <input type="button" value="Select All"/> <input type="button" value="Clear All"/> <input type="button" value="Undo All"/> </p>		0:00	6:00	12:00	18:00	24:00	Sun						Mon						Tue						Wed						Thu						Fri						Sat				
	0:00	6:00	12:00	18:00	24:00																																											
Sun																																																
Mon																																																
Tue																																																
Wed																																																
Thu																																																
Fri																																																
Sat																																																
	<input type="radio"/> Recurrence Pattern																																															
Event	Motion Detection <input type="checkbox"/> Window 1 <input type="checkbox"/> Window 2 <input type="checkbox"/> Window 3																																															
Action	<input type="checkbox"/> Save Stream to <input type="text" value="SD card"/> <input type="button" value="v"/> <input type="checkbox"/> Send Snapshot to <input type="text" value="FTP"/> <input type="button" value="v"/> <input type="checkbox"/> Play Audio Clip : There is no available audio clip. Configure one here <input type="checkbox"/> Send HTTP Notification <input type="checkbox"/> Send to Email <input type="checkbox"/> LED Light <input type="checkbox"/> Send UDP Notification to IP address <input type="text"/> . <input type="text"/> . <input type="text"/> . <input type="text"/> Port <input type="text"/> <input type="checkbox"/> Send Multicast Notification to IP address <input type="text"/> . <input type="text"/> . <input type="text"/> . <input type="text"/> Port <input type="text"/>																																															
<input type="button" value="Apply"/> <input type="button" value="Cancel"/>																																																

A Scheduled Event can be programmed for certain times and day. Click individual boxes to schedule specific times for the camera to detect events.

- b. If Recurrence Pattern is selected, the following page will be displayed.

Event Settings

Event List			
Enabled	Name	Event Type	Action
<input checked="" type="checkbox"/>	12345	Motion Detection	Send to Email
<input checked="" type="checkbox"/>	abcde	PIR	Take Snapshot
<input checked="" type="checkbox"/>	asdf	Audio	LED Light

Enabled	<input checked="" type="checkbox"/>
Name	<input type="text" value="asdf"/>
Event Schedule	<input type="radio"/> Always <input type="radio"/> Schedule <input checked="" type="radio"/> Recurrence Pattern Sun <input checked="" type="checkbox"/> Mon <input type="checkbox"/> Tue <input type="checkbox"/> Wed <input checked="" type="checkbox"/> Thu <input type="checkbox"/> Fri <input type="checkbox"/> Sat <input type="checkbox"/> Start <input type="text" value="00"/> : <input type="text" value="07"/> Duration <input type="text" value="10"/> Minutes
Event	Audio Detection
Action	<input type="checkbox"/> Save Stream to <input type="text" value="SD card"/> <input type="checkbox"/> Send Snapshot to <input type="text" value="FTP"/> <input type="checkbox"/> Play Audio Clip : There is no available audio clip. Configure one here <input type="checkbox"/> Send HTTP Notification <input type="checkbox"/> Send to Email <input checked="" type="checkbox"/> LED Light <input type="checkbox"/> Send UDP Notification to IP address <input type="text"/> . <input type="text"/> . <input type="text"/> . <input type="text"/> Port <input type="text"/> <input type="checkbox"/> Send Multicast Notification to IP address <input type="text"/> . <input type="text"/> . <input type="text"/> . <input type="text"/> Port <input type="text"/>

- i. An event schedule can be programmed to recur at different times according to the user's needs. Select the days for the event schedule to occur. Select a start time and specify the duration.
3. Define what will trigger an event to occur by selecting an option from the Event drop-down list.
4. Select the Actions that will occur when the event is triggered.

a. When <Send to Email> is selected, the following page will be shown:

Enable	<input type="checkbox"/>
Name	<input type="text"/>
Event Schedule	<input checked="" type="radio"/> Always <input type="radio"/> Schedule <input type="radio"/> Recurrence Pattern
Event	Motion Detection ▾ <input type="checkbox"/> Window 1 <input type="checkbox"/> Window 2 <input type="checkbox"/> Window 3
Action	<input type="checkbox"/> Save Stream to FTP ▾ <input type="checkbox"/> Send Snapshot to FTP ▾ <input type="checkbox"/> Play Audio Clip : There is no available audio clip. Configure one here <input type="checkbox"/> Send HTTP Notification <input checked="" type="checkbox"/> Send to Email <input type="checkbox"/> LED Light <input type="checkbox"/> Send UDP Notification to IP address <input type="text"/> . <input type="text"/> . <input type="text"/> . <input type="text"/> Port <input type="text"/> <input type="checkbox"/> Send Multicast Notification to IP address <input type="text"/> . <input type="text"/> . <input type="text"/> . <input type="text"/> Port <input type="text"/>
Email	Sender <input type="text"/> TO <input type="text"/> CC <input type="text"/> Sender's Name <input type="text"/> Subject <input type="text"/>

- i. Sender - Enter the email address of the sender.
 - ii. Recipient - Enter the email address of the recipient. To enter multiple recipients, separate each using a comma.
 - iii. Sender's Name – Enter the sender's name that will appear in the recipient's inbox.
 - iv. Subject - Enter the title of the email.
5. When complete, click **Apply** to save new event or **Cancel** to delete the event. The new event will appear on the event list.
 6. To edit an event setting; select the event from the list. To remove an event setting from the list, select an event name from the list and then click <Delete Event>. Click <Add Event> to add more events.



NOTE - Refer to the Audio Clip section for more details about the “Play Audio Clip” action.

Motion Detection

Motion can be detected by measuring changes in the speed or vector of an object or objects in the monitored area. This section explains how to configure the Network Camera to enable motion detection.

Detection Settings

Region Settings

- Enable Window 1
- Enable Window 2
- Enable Window 3

Sensitivity

Threshold

Use the mouse to resize or move the Motion Detection Window. This chart records the amount of activity within the Motion Detection Window. When the activity level is above the threshold, the user will be notified..

※The MD setting is only activate in stream 1 .

Apply Cancel

Detection Setting – Use this setting to enable and define the motion detection windows. The user can defined up to three areas on the live view window for motion detection.

1. Select <Window1>, <Window2>, or <Window3> to adjust the motion detection window.
2. Check the box to enable the window.
3. Use the mouse to resize or move the motion detection window.
4. Adjust the “Sensitivity” level. Lower sensitivity levels will result in more activity needed to trigger an event.
5. Adjust the “Threshold” to change the threshold level. The higher the threshold, the larger objects need to be to trigger an event.
6. The chart below the Live View window indicates the activity level of the Motion Detection window. When motion is detected by the camera and exceeds the defined threshold, a red bar will appear. Users can use this feature as a trigger source to send photos or videos to a remote server via email or FTP.

Click **Apply** to apply settings or **Cancel** to cancel changes.

PIR(*)

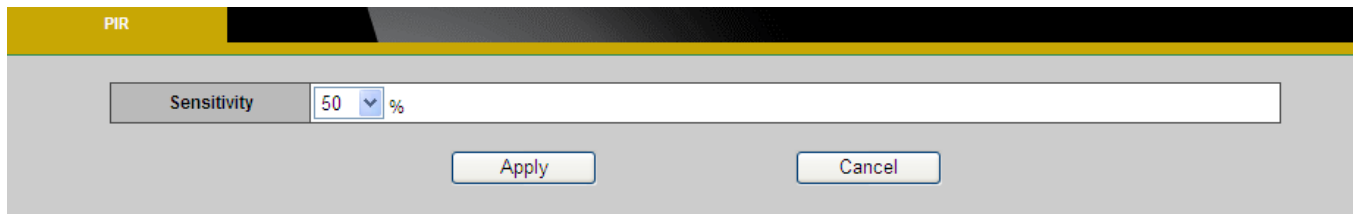

The PIR (Passive InfraRed) sensor measures infrared light radiating from objects in its field of view. This can be used to detect a moving object, such as a person, in dimly lit areas.

Sensitivity – Adjust the sensitivity of the PIR Sensor from the drop down menu. The sensitivity can be set from 10 - 100%; with the default sensitivity set at 50%. Higher sensitivity levels will increase the range of the PIR Sensor. When the sensitivity level is set to 100%, the PIR sensor will be able to detect moving objects within six meters.

Audio Detection

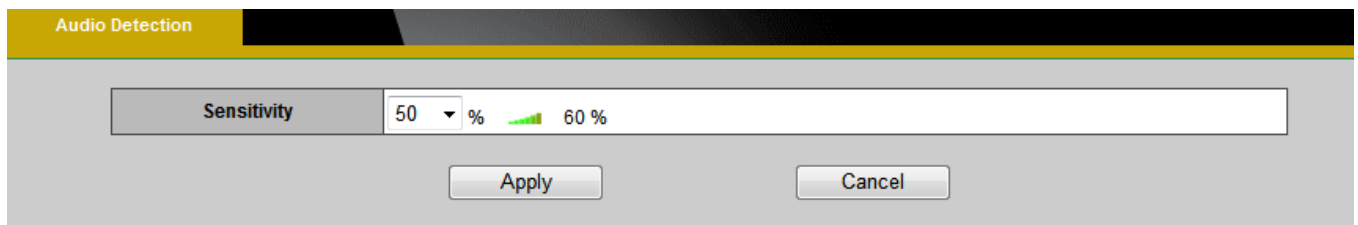

Users can schedule an event to be triggered if there is a change in the sound level of a monitored area. Audio detection can be used to measure change in the ambient voice. Select the sensitivity from the drop-down menu.

Sensitivity - is used to adjust the sensitivity of the sound level from 10 - 100%. The default sensitivity is 50%.

 60 % Display the current sound level.

Click **Apply** to apply settings or **Cancel** to cancel changes.

Notifications

Use the tools in this section to specify what type of notification will be sent when an event occurs. The camera can send buffered images to an FTP server, Samba, Email, or HTTP.

FTP Settings

File Transfer Protocol (FTP) is used as an application component to automatically transfer files for program internal functions. Select “Primary FTP Server” from the Server Selection drop down menu to send media files to a FTP server when an event is triggered. Enter the FTP IP address or hostname. By default, the FTP port server is set to 21. Enter the account name, password and FTP Path to configure the settings.

FTP Settings	
Server Selection	Primary FTP Server
FTP Address	IP Address 0 . 0 . 0 . 0
FTP Port	21
Account Name	
Account Password	
FTP Path	

Apply Test Cancel

Click **Apply** to apply settings or **Cancel** to cancel changes.

E-mail Settings

Select “Primary Email Server” option from the Server Selection drop down menu to send media files to an email server when an event is triggered.

SMTP Server - Enter the server host name of the email server.

SMTP Port - Enter the port number of the email server; by default, the SMTP port is set to 25.

Authentication - Select the authentication type from the drop-down menu.

Email Account - Enter the user name of the email account if necessary.

Email Password - Enter the password of the email account if necessary.

Server Selection	Primary Email Server
SMTP Server	
SMTP Port	25
Authentication	LOGIN
Email Account	
Email Password	

Apply Test Cancel

Click **Apply** to apply settings or **Cancel** to cancel changes.

Samba Settings

Select this option to send the media files via a network neighborhood when an event is triggered.

Server Address - Enter the IP address of the Samba server.

User Name - Enter the user name of the Samba server.

Password - Enter the password of the Samba server.

Work Group - Enter the workgroup of the Samba server.

Shared Folder - Enter the share folder of the Samba server.

Server Address	IP Address	0	0	0	0
Username					
Password					
WorkGroup					
Shared Folder					

Apply Test Cancel

Click **Apply** to apply settings or **Cancel** to cancel changes.

HTTP Settings

Select this option to send the media files via an HTTP notification when an event is triggered.

HTTP Settings	
URL	<input type="text"/>
Message	<input type="text"/>
Username	<input type="text"/>
Password	<input type="text"/>

URL –Specify the URL to send HTTP requests. The URL is normally written as:

[http://ip_address/ notification.cgi?parameter](http://ip_address/notification.cgi?parameter)

ip_address – type the IP address or host name of the HTTP host.

Parameter – type the notification parameter if necessary.

Example

URL - <http://192.168.1.1/xxxx.cgi>

Message - name1=value1&name2=vlaue2

Result - [http://192.168.1.1/xxxx.cgi? name1=value1&name2=vlaue2](http://192.168.1.1/xxxx.cgi?name1=value1&name2=vlaue2)

Ex:

<https://192.168.1.1/notification.cgi?event=MD&camera=FB-100A>

Message - Enter the message notification that will be sent when an event is triggered.

Enter the user name and password if necessary.

Click **Apply** to apply settings or **Cancel** to cancel changes.

Video Clip

Video Clip	
Pre-Alarm Buffer	<input type="text" value="5"/> Seconds (0-10)
Post-Alarm Buffer	<input type="text" value="5"/> Seconds (0-30)
Maximum Buffer Size	<input type="text" value="1024"/> Kbytes (128-1500)

This function is used to determine when video clips will be recorded and stored after an event is triggered.

Pre-alarm buffer - Images can be stored internally on the server from the time immediately preceding the trigger. Enter the desired length of time.

Post-alarm buffer - Images can be stored internally on the server from the time immediately following the trigger. Enter the desired length of time.

Maximum buffer size –Specify the maximum file size allowed.

Click **Apply** to apply settings or **Cancel** to cancel changes.

Audio Clip(*)

Audio Recording – Audio clips can be recording and played when an event occurs.

The screenshot displays the 'Audio Recording' interface. At the top, there is a yellow header with the text 'Audio Recording'. Below this is a table titled 'Audio Clip List' with two columns: 'Index' and 'File Name'. The first row contains the value '1' in the 'Index' column and '11111.wav' in the 'File Name' column. Below the table are four buttons: 'Play', 'Stop', 'Delete', and 'Export'. Underneath these buttons is an 'Import' section with the text 'Please select a file to import' followed by a text input field, a 'Browse...' button, and an 'Import' button. At the bottom is the 'Audio Recording Settings' section, which includes a 'File Name' text input field, a 'Duration' dropdown menu set to '5' with a 'Second' label, and a 'Record' button.

Click **Browse** to import a file from a local hard drive or network disk. Select the file and click

Import.  **NOTE** – The camera can only play audio clips which are saved as .wav files with G.711 u-law encoding in 8000 Hz sampling rate.

To record a new clip using the camera's microphone:

1. File Name-Enter a file name.
2. Duration - Enter the number of seconds to record.
3. Click **Record** to record the new audio clip.
4. The new audio clip will appear on the audio clip list.
5. Select an audio clip file from the Audio Clip List.
 - a. Play- Select to hear the audio clip
 - b. Stop- Select to stop playing the audio clip.
 - c. Delete- Select to delete an audio clip.
 - d. Export- Select to export the audio clip to a local hard drive or network disk.

LED Light(*)

LED Light	
Mode	<input checked="" type="radio"/> Keep active during event <input type="radio"/> Keep active for 1 Sec (1~10)
LED Control	Activate: On Inactivate: Off

Apply Cancel

Mode – Select “Keep active during event” or “Keep active for” a specific amount of time when an event is triggered.

LED Control - The LED on the front of the camera can be set to flash at a configurable interval when an event is triggered. From the Activate drop down menu, select a percentage which the LED will brighten to. When the LED reaches the selected percentage, it can be configured to fade to off or turn off. Select the option from the Inactivate menu.

Click **Apply** to apply settings or **Cancel** to cancel changes.

System

System Log

Log – Set up the camera to record a system log when an event is triggered.

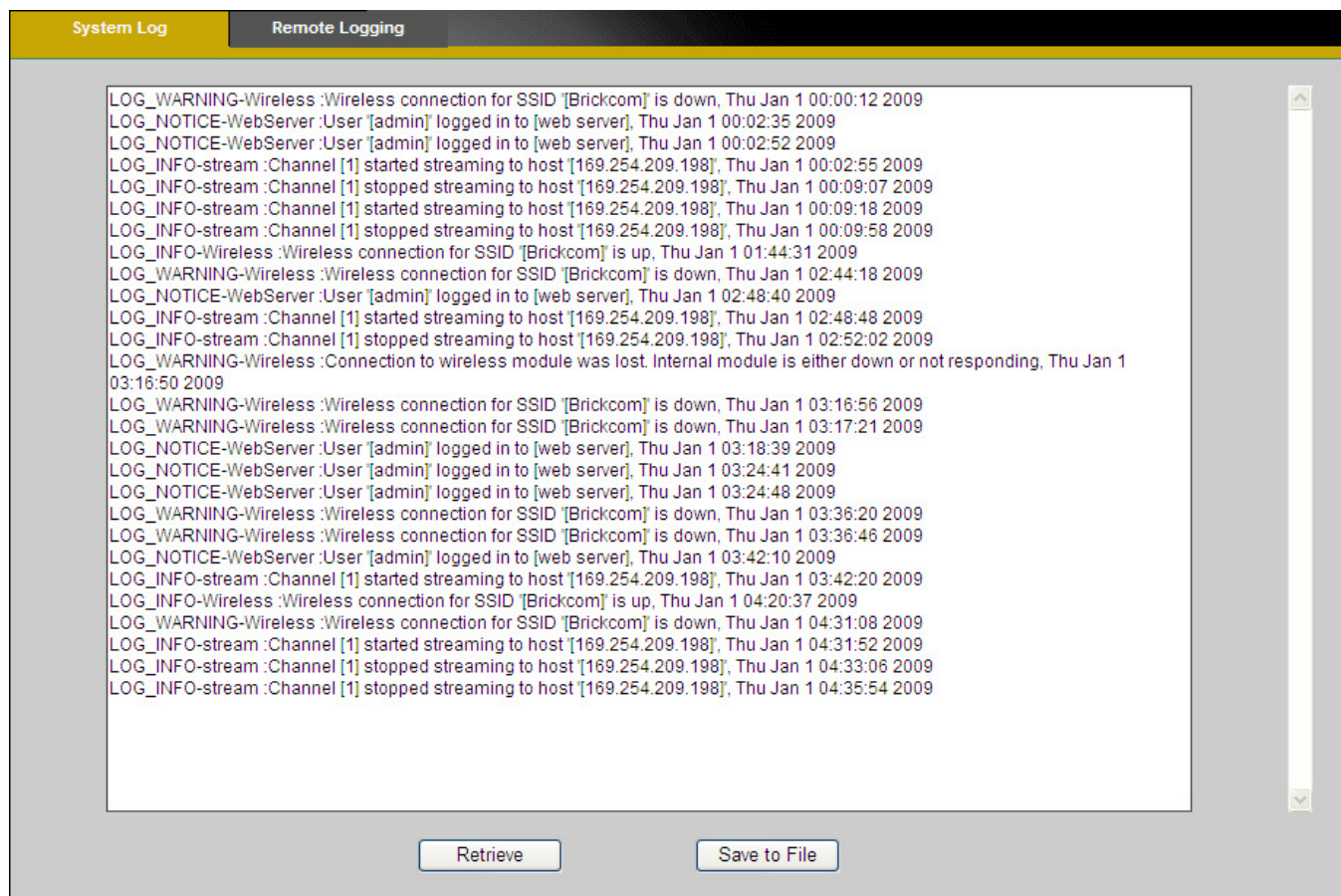

The screenshot shows a web interface for viewing system logs. At the top, there are two tabs: "System Log" (selected) and "Remote Logging". Below the tabs is a large text area containing a list of log entries in chronological order. The entries include various messages such as "Wireless connection for SSID [Brickcom] is down", "User [admin] logged in to [web server]", and "Channel [1] started/stopped streaming to host [169.254.209.198]". At the bottom of the interface, there are two buttons: "Retrieve" and "Save to File".

```
LOG_WARNING-Wireless :Wireless connection for SSID [Brickcom] is down, Thu Jan 1 00:00:12 2009
LOG_NOTICE-WebServer :User [admin] logged in to [web server], Thu Jan 1 00:02:35 2009
LOG_NOTICE-WebServer :User [admin] logged in to [web server], Thu Jan 1 00:02:52 2009
LOG_INFO-stream :Channel [1] started streaming to host [169.254.209.198], Thu Jan 1 00:02:55 2009
LOG_INFO-stream :Channel [1] stopped streaming to host [169.254.209.198], Thu Jan 1 00:09:07 2009
LOG_INFO-stream :Channel [1] started streaming to host [169.254.209.198], Thu Jan 1 00:09:18 2009
LOG_INFO-stream :Channel [1] stopped streaming to host [169.254.209.198], Thu Jan 1 00:09:58 2009
LOG_INFO-Wireless :Wireless connection for SSID [Brickcom] is up, Thu Jan 1 01:44:31 2009
LOG_WARNING-Wireless :Wireless connection for SSID [Brickcom] is down, Thu Jan 1 02:44:18 2009
LOG_NOTICE-WebServer :User [admin] logged in to [web server], Thu Jan 1 02:48:40 2009
LOG_INFO-stream :Channel [1] started streaming to host [169.254.209.198], Thu Jan 1 02:48:48 2009
LOG_INFO-stream :Channel [1] stopped streaming to host [169.254.209.198], Thu Jan 1 02:52:02 2009
LOG_WARNING-Wireless :Connection to wireless module was lost. Internal module is either down or not responding, Thu Jan 1
03:16:50 2009
LOG_WARNING-Wireless :Wireless connection for SSID [Brickcom] is down, Thu Jan 1 03:16:56 2009
LOG_WARNING-Wireless :Wireless connection for SSID [Brickcom] is down, Thu Jan 1 03:17:21 2009
LOG_NOTICE-WebServer :User [admin] logged in to [web server], Thu Jan 1 03:18:39 2009
LOG_NOTICE-WebServer :User [admin] logged in to [web server], Thu Jan 1 03:24:41 2009
LOG_NOTICE-WebServer :User [admin] logged in to [web server], Thu Jan 1 03:24:48 2009
LOG_WARNING-Wireless :Wireless connection for SSID [Brickcom] is down, Thu Jan 1 03:36:20 2009
LOG_WARNING-Wireless :Wireless connection for SSID [Brickcom] is down, Thu Jan 1 03:36:46 2009
LOG_NOTICE-WebServer :User [admin] logged in to [web server], Thu Jan 1 03:42:10 2009
LOG_INFO-stream :Channel [1] started streaming to host [169.254.209.198], Thu Jan 1 03:42:20 2009
LOG_INFO-Wireless :Wireless connection for SSID [Brickcom] is up, Thu Jan 1 04:20:37 2009
LOG_WARNING-Wireless :Wireless connection for SSID [Brickcom] is down, Thu Jan 1 04:31:08 2009
LOG_INFO-stream :Channel [1] started streaming to host [169.254.209.198], Thu Jan 1 04:31:52 2009
LOG_INFO-stream :Channel [1] stopped streaming to host [169.254.209.198], Thu Jan 1 04:33:06 2009
LOG_INFO-stream :Channel [1] stopped streaming to host [169.254.209.198], Thu Jan 1 04:35:54 2009
```

This page displays the system's log in chronological order. The system log is stored in the camera's buffer area and will be overwritten when the buffer area is full.

Click **Retrieve** to retrieve the log or click **Save to file** to save the system log.

Remote Logging

System Log	Remote Logging
Enabled	<input type="checkbox"/>
IP Address	0 . 0 . 0 . 0 Port 514
Apply Cancel	

The user can configure the camera to send the system log file to a remote server as a log backup.

Click to enable remote log and enter the IP address of the remote server.

Enter the port number of the remote server.

Click **Apply** to apply settings or **Cancel** to cancel changes.

Date and Time

Manual – Manually enter the date and time.

Clone from PC – The camera will sync with the time, date and time zone of the computer used to modify the camera settings. Check “Clone” to utilize this option. The read-only date and time of the PC will be displayed.

NTP – (Network Time Protocol) - NTP is a protocol for synchronizing the clocks of a computer system. Select to update the time with a NTP server on an hourly, daily, weekly, or monthly basis.

Time Zone – Select the local time zone from drop-down menu.

NTP Server 1 and Server 2 - Enter the address of the NTP server

Daylight Saving - Enable this option to automatically update for Daylight Savings Time.

Date and Time	
Manual	Year 2009 Month 1 Day 1 Hour 0 Minute 0 Second 0
Clone from PC	Year 2010 Month 8 Day 3 Hour 17 Minute 27 Second 33
	<input type="checkbox"/> Clone
NTP	TimeZone (GMT+8)HONG KONG
	NTP Server 1 tick.stdtime.gov.tw
	NTP Server 2 clock.stdtime.gov.tw
	Daylight Saving <input checked="" type="checkbox"/> Enabled
Apply Cancel	

Click **Apply** to apply settings or **Cancel** to cancel changes.

Device Information

System Information – Displays the complete system information of the camera.

System Information	Network Settings	Video/Audio Settings	Client Information
LAN MAC Address	00:26:82:B6:3C:7B		
Firmware Version	v3.1.0.2		
Product Name	CB-100Ap		
Hardware Version	V2		
Company Name	Brickcom Corporation		
UPnP Name	CB-100Ap-3c7b		

Network Settings –Displays the complete network settings information of the camera.

System Information	Network Settings	Video/Audio Settings	Client Information
IP Information			
IP Setting Type	DHCP		
IP Address	192.168.1.21		
Subnet Mask	255.255.255.0		
Default Gateway	192.168.1.2		
Primary DNS	192.168.1.2		
Secondary DNS	192.168.1.2		
Network Services			
UPnP	Enabled		
DynDNS	Disabled		
TZO	Disabled		
NO-IP	Disabled		

Video/Audio Settings –Displays the complete video/audio settings information of the camera.

System Information	Network Settings	Video/Audio Settings	Client Information
Stream 1			
Video Codec	H.264		
Video Resolution	1280x800		
Video Frame Rate	25 fps		
Video Bitrate	4000 Kbps		
Audio Codec	N/A		
Multicast IP	N/A		
Stream 2			
Video Codec	MJPEG		
Video Resolution	1280x800		
Video Frame Rate	25 fps		
Video Quality	3		
Audio Codec	N/A		
Multicast IP	N/A		

Wireless - Displays the complete wireless information of the camera.

System Information	Network Settings	Video/Audio Settings	Wireless
Wireless MAC Address	00:26:82:1B:DB:92		
Radio Band	Auto-20/40MHz Channel		
Network Mode	BGN-Mixed		
Security	Disabled		
Network Name (SSID)	Brickcom_MARS		
Wireless Channel	6		
Wireless Signal Strength	85%		
Status	Connected		

Client Information- Displays the RTSP Client .You will see a list of RTSP clients with the following information: IP Address and channel.

System Information	Network Settings	Video/Audio Settings	Client Information
Index	IP Address	Channel	
			<input type="button" value="Refresh"/>

Storage Management (*)

Storage Management is used to view all the recorded files on the Micro-SD/SDHC card.

The screenshot displays the 'Storage Management' interface. At the top, there are two tabs: 'Storage Management' (selected) and 'Advanced Settings'. Below the tabs is a table titled 'Local Storage Information' with the following data:

Item	SD Card
Total Capacity	7.41GB
Used Space	2.27GB
Available Space	5.14GB

Below the table is a 'Memory Card Management' section with three buttons: 'Reload', 'Remove', and 'Format'. To the right of these buttons is a file explorer view showing a folder named 'sd' containing four sub-folders: 'offline', 'schedule', 'snapshot', and 'videoclip'. The left pane of the file explorer is empty, and the text 'Storage Management' is visible in the background.

Click **Reload** to refresh the list of recorded files.

Click **Remove** to safely remove the Micro-SD/SDHC memory card.

Click **Format** to format the Micro-SD/SDHC memory card.

Left click on the folder to list the recorded files. The user can either play the snapshot of the recorded files by moving the mouse pointer over the file or double click on a file to play it.

Right click on the folder to download, play or delete the recorded files.



NOTE – The user may need to install QuickTime multimedia framework to play the video clips.

Advanced Settings

Storage Management		Advanced Settings	
Automatic Recycle			
Enable	<input checked="" type="checkbox"/>		
Offline Record			
Enable	<input type="checkbox"/>		
File Encryption			
Enable	<input type="checkbox"/>		
Password	<input type="text"/>		
Encryption Ciphers	AES128		

If the Automatic Recycle function is disabled, there must be at least 50MB Hard Drive space available for the network camera to record video.

If the Automatic Recycle function is enabled, it will automatically overwrite the recorded files when the available space remaining is less than 100MB.

Automatic Recycle (*) – Enable to automatically overwrite older files when the available space remaining on the Micro-SD/SDHC card is less than 100MB. If the Automatic Recycle function is disabled, there must be at least 50MB hard drive space available for the camera to be able to record video files.

Offline Record – Enable to keep recording if the Network Camera is offline.

File Encryption – Enable the File Encryption to encrypt recorded video files. Files are encrypted using OPENSSL.

To unlock the encrypted file, please download and install the OPENSSL toolkit from the OPENSSL Web site.

<http://gnuwin32.sourceforge.net/packages/openssl.htm>

Use the following command to encrypted file:

```
openssl enc -ciphername [-in filename] [-out filename] [-pass arg] [-e] [-d] [-a/-base64] [-A] [-k password] [-kfile filename] [-K key] [-iv IV] [-S salt] [-salt] [-nosalt] [-z] [-md] [-p] [-P] [-bufsize number] [-nopad] [-debug] [-none] [-engine id]
```

For example: `openssl enc -d -aes128 -in encryptfile -out decryptfile -k password`

Click **Apply** to apply settings or **Cancel** to cancel changes.

LED Indicators

The LED on the front of the camera can be configured to remain unlit. Check “OFF” to enable

this function.

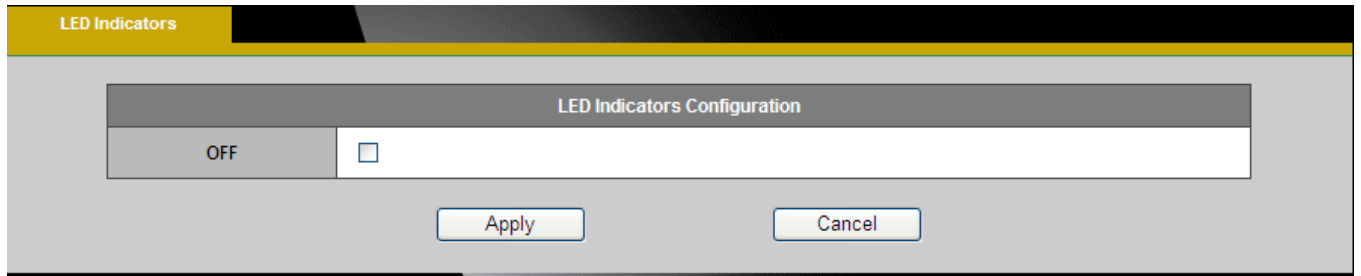

Click **Apply** to apply settings or **Cancel** to cancel changes.

Maintenance

User Management

This section explains how to enable password protection and create multiple accounts.

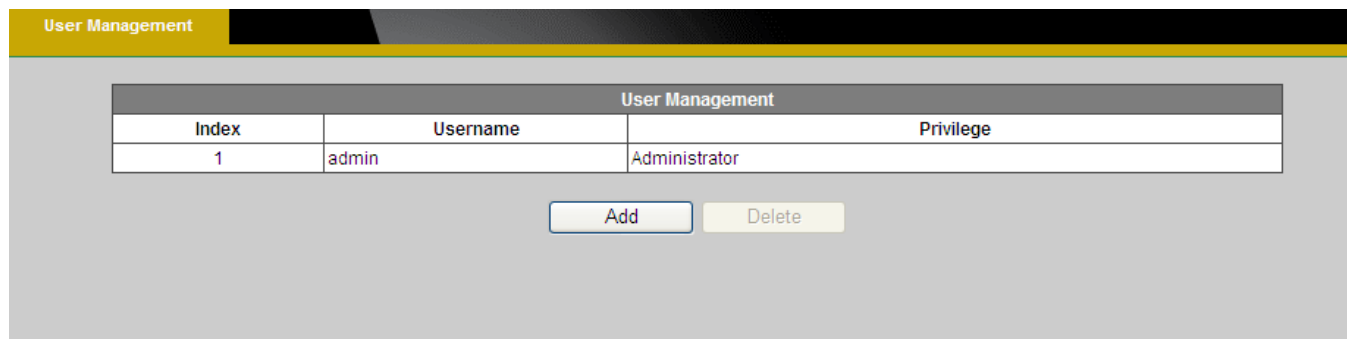

The administrator account name is “admin”, which is permanent and cannot be deleted. Click **Add** to create an account.

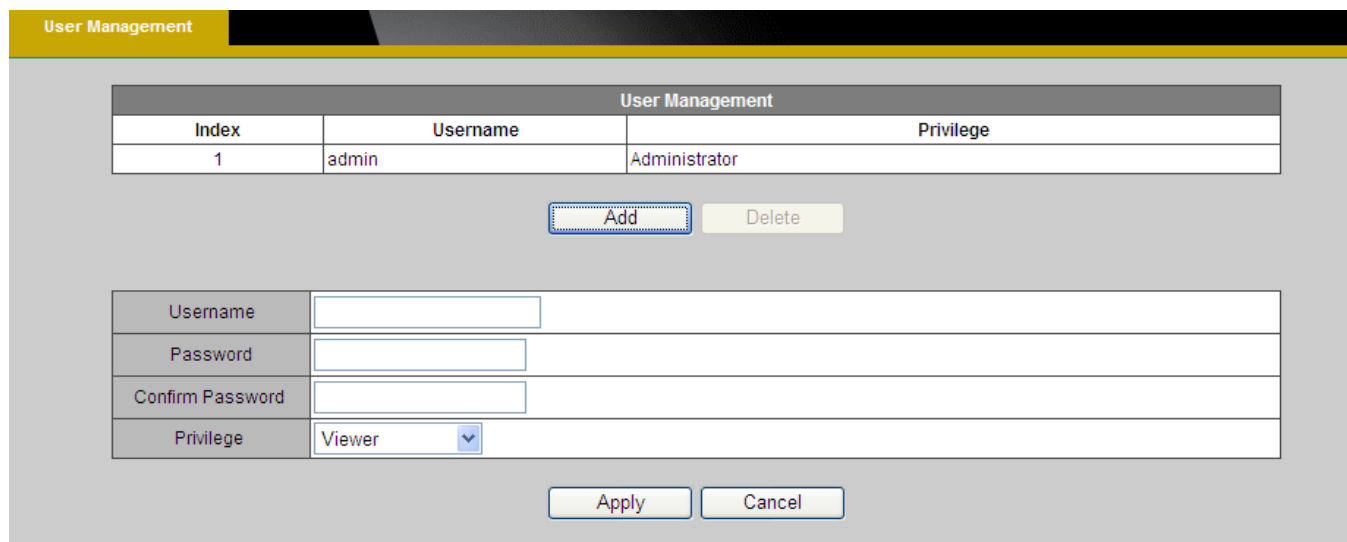

Enter the new user’s name, password and confirm password. Administrators can add up to 10 user accounts.

Select the privilege level for the new user account from the drop-down list. Privilege levels can be assigned as:

- ◆ Administrator - user has access to view and change the Configuration page. Users with administrator privilege can change other user's access rights and delete user accounts. Click **Delete** or **Update** to delete or modify a user's account.
- ◆ Viewer - user can only access the main page for live viewing.
- ◆ Remote Viewer - user can only access the main page for live viewing using TCP protocol.

Language

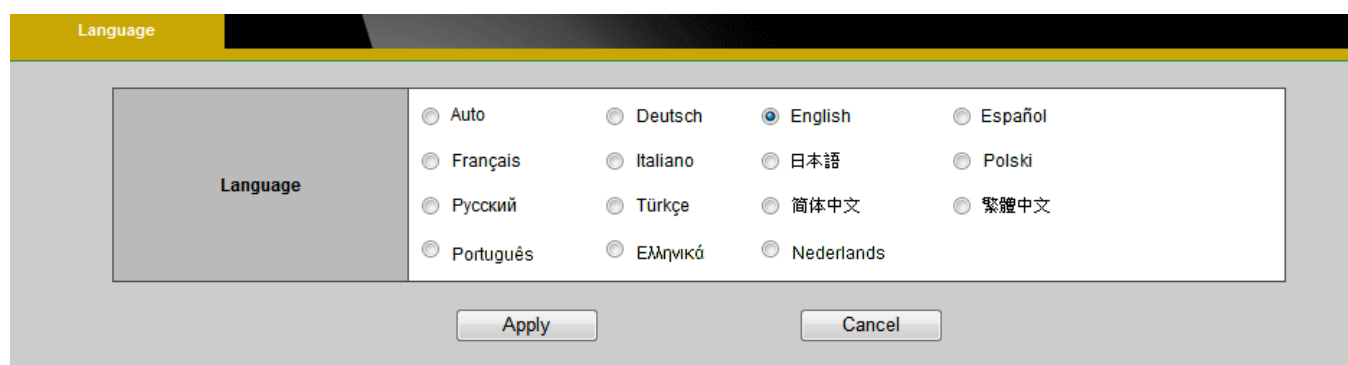

Select the desired language from the radio button.

Click **Apply** to apply settings or **Cancel** to cancel changes.

IP Filter

The IP Filter is used to filter the IP addresses which are able to access the network camera. Enable the IP Filter and select to allow or deny a range of IP addresses access to the server. Click **Add to list** to add the IP range to the IP filter list.

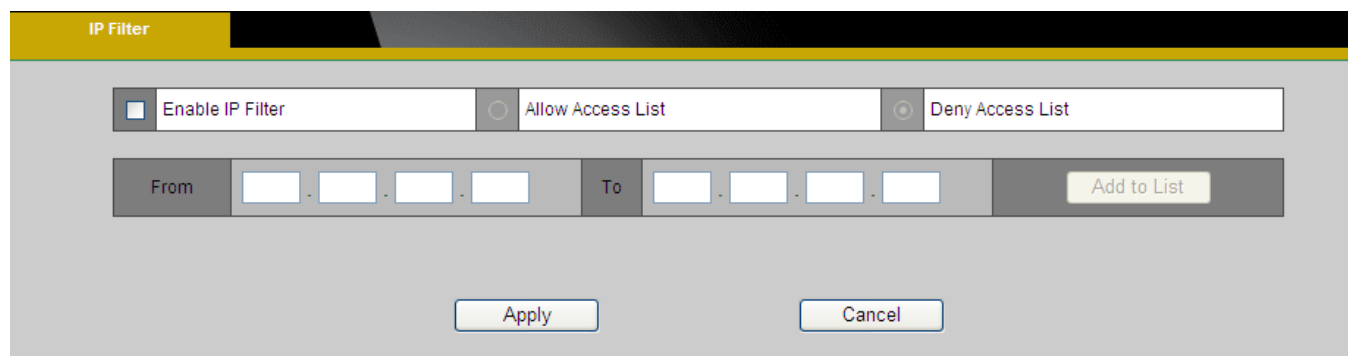

Click **Apply** to apply settings or **Cancel** to cancel changes.

Firmware Upgrade

This feature allows the user to upgrade the camera firmware. It will take a few minutes to complete the process.



NOTE - Do not power off the camera or camera during the upgrade.

Upgrade - Click **Browse...** and specify the firmware file. Click **Upgrade**. The camera will begin upgrading and will reboot automatically when the upgrade is finished.

Firmware Upgrade	
Select a File	<input type="text"/> <input type="button" value="Browse..."/> <input type="button" value="Upgrade"/>

Configuration

This feature allows the user to export/import the configuration files of the network camera.

Import/Export - Click **export** to pop up a dialog to indicate the location and file to export. Click **browse** to indicate the location and file of the camera configuration and click **import** to import the configuration file back into the network camera.

Import / Export	
Export	<input type="button" value="Export"/>
Import	Please select a file to import <input type="text"/> <input type="button" value="Browse..."/>
	<input type="button" value="Import"/>

Reset to Default

This section is used to restore the camera to default factory settings. Check the boxes to preserve the IP, Wireless, Date and Time, EasyLink, or Language settings. Click **Apply** to restore the camera to default factory settings.

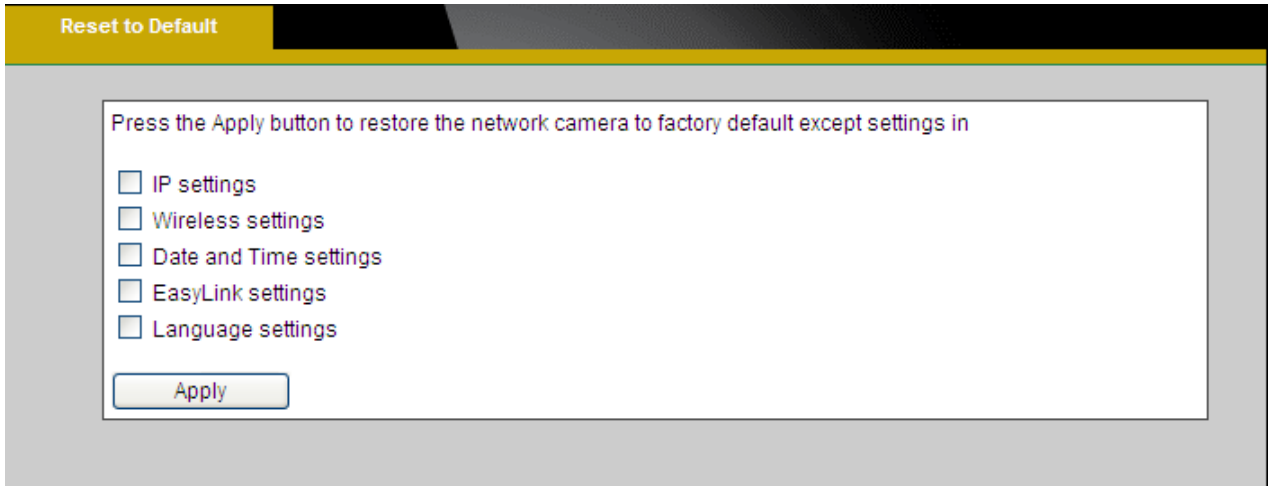

Reboot

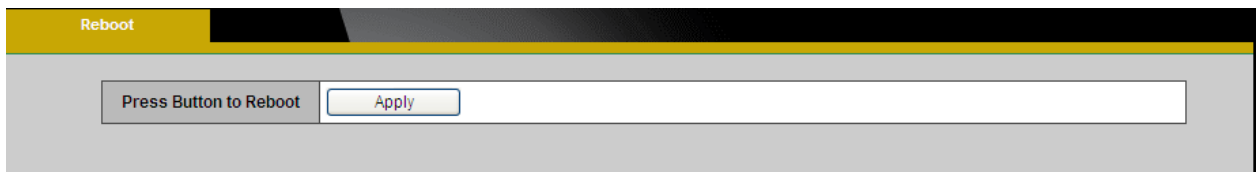

This feature will reboot the camera. Click **Apply** to begin. A message will pop up asking “The device will reboot. Are you sure?” Click “OK” to continue. The camera will take about one minute to reboot.

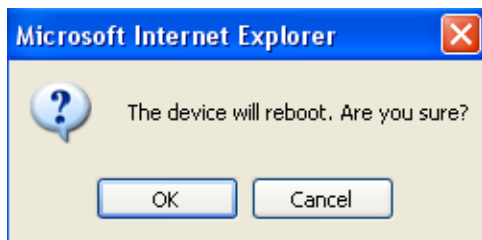

The following message will show during the rebooting process.

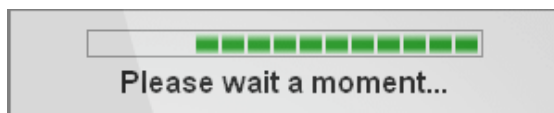

When completed, the live video page will be displayed in the web browser.