



4” Outdoor Dome Series Hardware Manual

D71, D72, D81, D82, E71, E72, E73,
E74, E81, E82, E83, E84, E85, E86,
E87

2013/03/06



ACTi
Connecting Vision

Table of Contents

Precautions	3
--------------------------	----------

Introduction.....	4
--------------------------	----------

The List of Models	4
Package Contents	5
Safety Instructions	6
Physical Description	7

Installation and Access	9
--------------------------------------	----------

Basic Connections	9
1) Remove the cover.....	9
2) Insert the cable.....	9
3) Adjust viewing angle and focus	9
Camera Installation	11
Mount the IP Outdoor Dome (Surface).....	12
Mount the IP Outdoor Dome (Flush)	13
Mount the IP Indoor Dome (Wall).....	14
How to Do the Waterproof with Conduit Installation	15
Accessing Camera	18

Precautions

Read these instructions

You should read all the safety and operating instructions before using this product.

Heed all warnings

You must adhere to all the warnings on the product and in the instruction manual. Failure to follow the safety instruction given may directly endanger people, cause damage to the system or to other equipment.

Servicing

Do not attempt to service this video device yourself as opening or removing covers may expose you to dangerous voltage or other hazards. Refer all servicing to qualified service personnel.

Trademarks

All names used in this manual are probably registered trademarks of respective companies.

Liability

Every reasonable care has been taken during the writing of this manual. Please inform your local office if you find any inaccuracies or omissions. We cannot be held responsible for any typographical or technical errors and reserve the right to make changes to the product and manuals without prior notice.















FCC/CE Regulation

NOTE: This equipment has been tested and found to comply with the limits for a Class B digital device, pursuant to Part 15 of the FCC Rules. These limits are designed to provide reasonable protection against harmful interference when the equipment is operated in a commercial environment. This equipment generates, uses, and can radiate radio frequency energy and, if not installed and used in accordance with the instruction manual, may cause harmful interference to radio communications. Operation of this equipment in a residential area is likely to cause harmful interference in which case the users will be required to correct the interference at their own expense.

Introduction

The List of Models

This hardware manual contains the following models:

D71		1MP Outdoor Dome with D/N, IR, Fixed lens, f2.93mm/F2.0, H.264, 720p/30fps, DNR, MicroSDHC, PoE, IP66, IK10
D72		3MP Outdoor Dome with D/N, IR, Fixed lens, f2.93mm/F2.0, H.264, 1080p/30fps, DNR, MicroSDHC, PoE, IP66, IK10
D81		1MP Outdoor Dome with D/N, IR, Vari-focal lens, f2.8-12mm/F1.4, H.264, 720p/30fps, DNR, MicroSDHC, PoE, IP66, IK10
D82		3MP Outdoor Dome with D/N, IR, Vari-focal lens, f2.8-12mm/F1.4, H.264, 1080p/30fps, DNR, MicroSDHC, PoE, IP66, IK10
E71		1MP Outdoor Dome with D/N, IR, Basic WDR, Fixed lens, f2.93mm/F2.0, H.264, 720p/30fps, DNR, MicroSDHC, PoE, IP66, IK10
E72		3MP Outdoor Dome with D/N, IR, Basic WDR, Fixed lens, f2.93mm/F2.0, H.264, 1080p/30fps, DNR, MicroSDHC, PoE, IP66, IK10
E73		5MP Outdoor Dome with D/N, IR, Basic WDR, Fixed lens, f2.93mm/F2.0, H.264, 1080p/30fps, DNR, MicroSDHC, PoE, IP66, IK10
E74		3MP Outdoor Dome with D/N, IR, Superior WDR, Fixed lens, f2.93mm/F2.0, H.264, 1080p/30fps, DNR, MicroSDHC, PoE, IP66, IK10
E81		10MP Outdoor Dome with D/N, IR, Basic WDR, Fixed lens, f3.6mm/F1.8, H.264, 1080p/30fps, DNR, MicroSDHC, PoE, IP66, IK10
E82		1MP Outdoor Dome with D/N, IR, Basic WDR, Vari-focal lens, f2.8-12mm/F1.4, H.264, 720p/30fps, DNR, MicroSDHC, PoE, IP66, IK10
E83		3MP Outdoor Dome with D/N, IR, Basic WDR, Vari-focal lens, f2.8-12mm/F1.4, H.264, 1080p/30fps, DNR, MicroSDHC, PoE, IP66, IK10
E84		5MP Outdoor Dome with D/N, IR, Basic WDR, Vari-focal lens, f2.8-12mm/F1.4, H.264, 1080p/30fps, DNR, MicroSDHC, PoE, IP66, IK10
E85		2MP Outdoor Dome with D/N, IR, Basic WDR, SLLS, Vari-focal lens, f2.8-12mm/F1.4, H.264, 1080p/30fps, DNR, MicroSDHC, PoE, IP66, IK10
E86		1MP Outdoor Dome with D/N, IR, Superior WDR, Vari-focal lens, f2.8-12mm/F1.4, H.264, 720p/30fps, DNR, MicroSDHC, PoE, IP66, IK10
E87		3MP Outdoor Dome with D/N, IR, Superior WDR, Vari-focal lens, f2.8-12mm/F1.4, H.264, 1080p/30fps, DNR, MicroSDHC, PoE, IP66, IK10

From the installation perspective these models are very similar; therefore you can use one manual for all of them.

Package Contents

1. Camera



OR



D71, D72, E71, E72, E73, E74

D81, D82, E81, E82, E83, E84, E85, E86, E87

2. Lens Focus Tuner



Only provided with following models: D71, D72, E71, E72, E73, E74

3. Conduit Gland (Watertight Fitting)



4. Screw Pack



These screws are for surface mounting. If you need to use specific mounting accessories, the screws are included in the package of mounting accessories

5. Quick Installation Guide



6. Warranty Policy

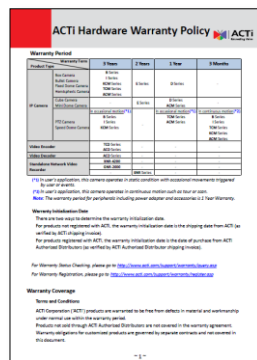

7. Drill Template

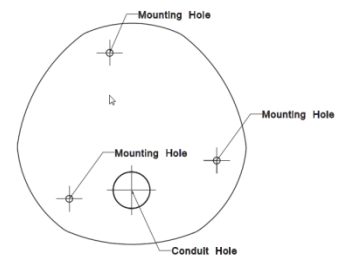

Safety Instructions

Cleaning

Disconnect this video product from the power supply before cleaning.

Attachments

Do not use attachments not recommended by the video product manufacturer as they may cause hazards.

Do not use accessories not recommended by the manufacturer

Only install this device in a dry place protected from weather

Servicing

Do not attempt to service this video product yourself. Refer all servicing to qualified service personnel.

Damage Requiring service

Disconnect this video product from the power supply immediately and refer servicing to qualified service personnel under the following conditions.

- 1) When the power-supply cord or plug is damaged
- 2) If liquid has been spilled, or objects have fallen into the video product.
- 3) If the inner parts of video product have been directly exposed to rain or water.
- 4) If the video product does not operate normally by following the operating Instructions in this manual. Adjust only those controls that are covered by the instruction manual, as an improper adjustment of other controls may result in damage, and will often require extensive work by a qualified technician to restore the video product to its normal operation.

Safety Check

Upon completion of any service or repairs to this video product, ask the service technician to perform safety checks to determine if the video product is in proper operating condition.

Physical Description

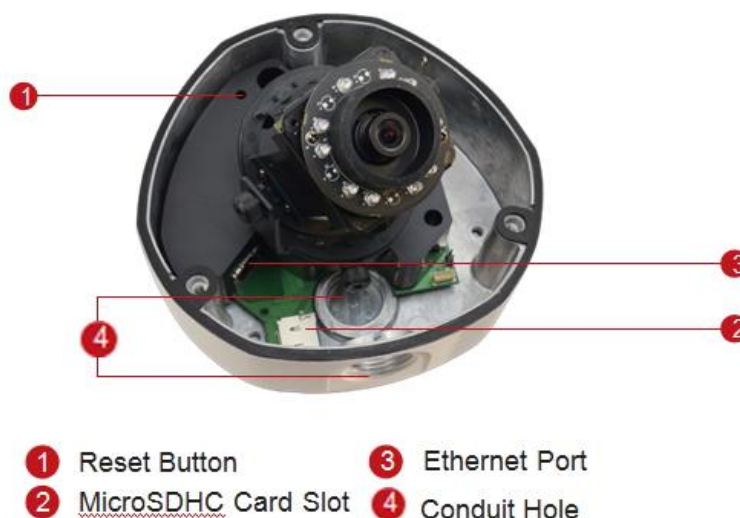

1) Reset Button

The purpose of reset button is to restore the factory default settings of the camera, including administrator's password.

The reset button can be used for following purposes:

1. The administrator's password has been forgotten and therefore the camera cannot be accessed.
2. In case of IP address, mask, or allow/deny filter related issues, resulting with inability to modify these settings.
3. In case of connectivity issues or abnormal video quality.

How to do the reset properly?

Step 1: Disconnect the power supply (e.g. disconnect the Ethernet cable with PoE).

Step 2: Press and continue to hold the Reset Button (using a pin).

Step 3: Connect the power supply while keeping the Reset Button pressed.

Step 4: Wait for 45 seconds and release the Reset Button.

2) Micro SDHC Card Slot

This slot only supports MicroSDHC standard. Do not use the MicroSD standard card. The card is not included. For more information about how to operate with MicroSDHC card, please refer to the Firmware User Manual.

3) Ethernet Port

The IP device connects to the Ethernet via a standard RJ45 connector.

4) Conduit Hole

Conduit holes are openings where cables pass through. There are two conduit holes on this device, used for different mounting angles.

Installation and Access

Basic Connections

1) Remove the cover

Remove the dome cover with Phillips screwdriver.



2) Insert the cable

There are two conduit holes on the outdoor dome. One is at the bottom, while the other is at the side and covered with a plug. Remove the plug if your cable will go through the one at the side of the outdoor dome

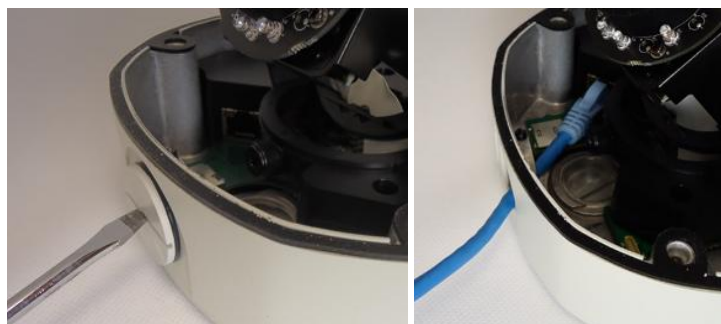

3) Adjust viewing angle and focus

The illustration shows where to adjust each axis.

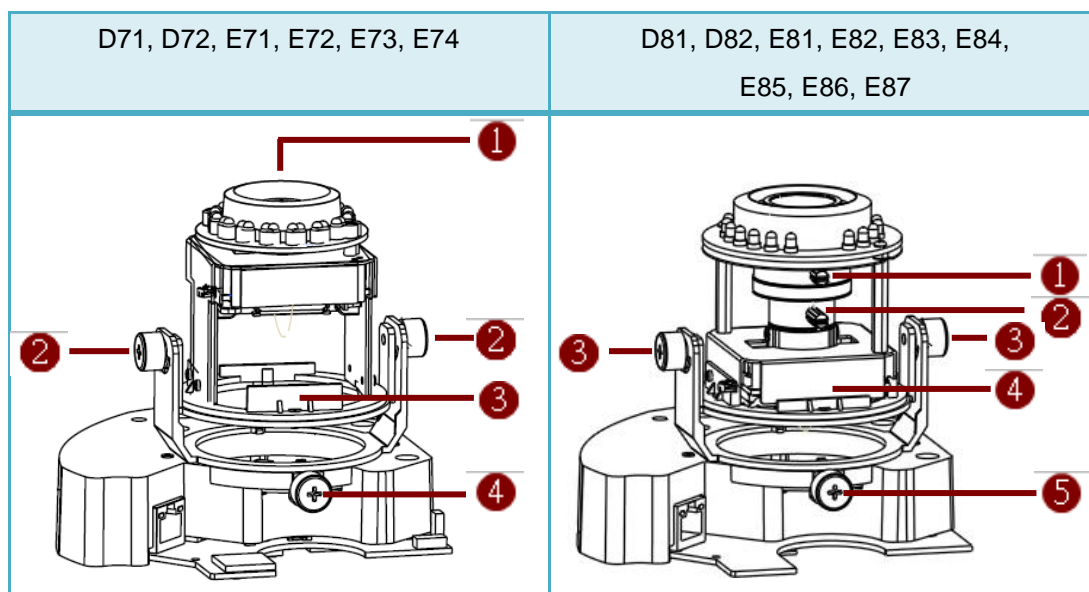

<ol style="list-style-type: none"> 1. Focus ring 2. Tilt adjustment screw 3. Rotation adjustment axis 4. Pan adjustment screw 	<ol style="list-style-type: none"> 1. Zoom lever 2. Focus lever 3. Tilt adjustment screw 4. Rotation adjustment axis 5. Pan adjustment screw
---	---

1. Based on the live view from the camera, please rotate the lens and adjust the viewing orientation with pan and tilt direction to make the dome camera work properly under given installation
2. Adjust the focus while giving a proper viewing orientation and clear image on the live view monitor.

For D7x and E7x series models, they are fixed lens cameras, the Lens Focus Tuner is included in the package to focus the fixed lens.

Attach the focus tuner on lens to adjust the focus of lens. Remove the lens focus tuner until the image is satisfactory.



For D8x and E8x series models, they are zoom lens cameras, please loosen the zoom and focus lock screws first, then adjust the zoom and focus. And please tighten these screws gently until the image is satisfactory.

3. Attach the dome cover to the camera.



Camera Installation

There are several popular mounting types of installation methods for this IP outdoor dome camera.

For more information about mounting solutions and accessories, please refer to the Buyer's Guide.

Mount Types	Accessories	
Surface Mount	Accessories not required 	
Flush Mount	PMAX-1003 	
L Type Wall Mount	PMAX-0308 	
Pendant Mount	PMAX-0101+ PAMX-0103 	
Gooseneck Pole Mount	PMAX-0101+ PMAX-0303 + PMAX-0503 	

Mount the IP Outdoor Dome (Surface)

This camera can be surface mounted without needing any additional accessories. Use the screws from the screw pack and mount the camera to the surface using following screw holes.



If you need to drill the holes to the surface first, such as concrete wall or ceiling, please use the drill template, provided in the camera package.

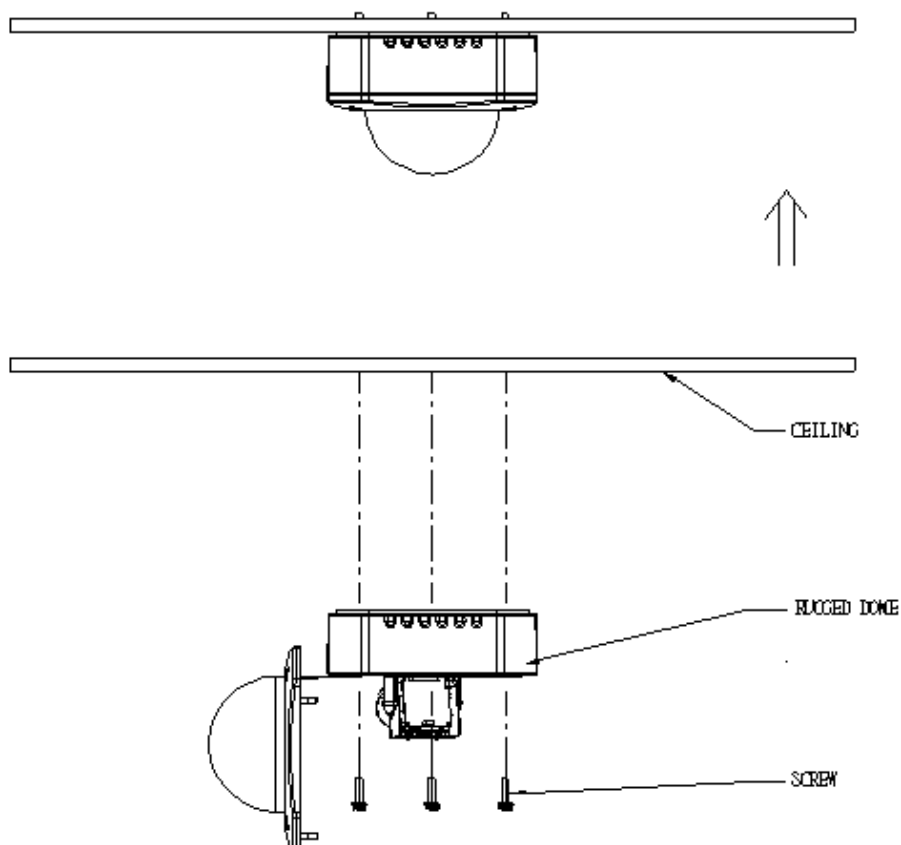

Mount the IP Outdoor Dome (Flush)

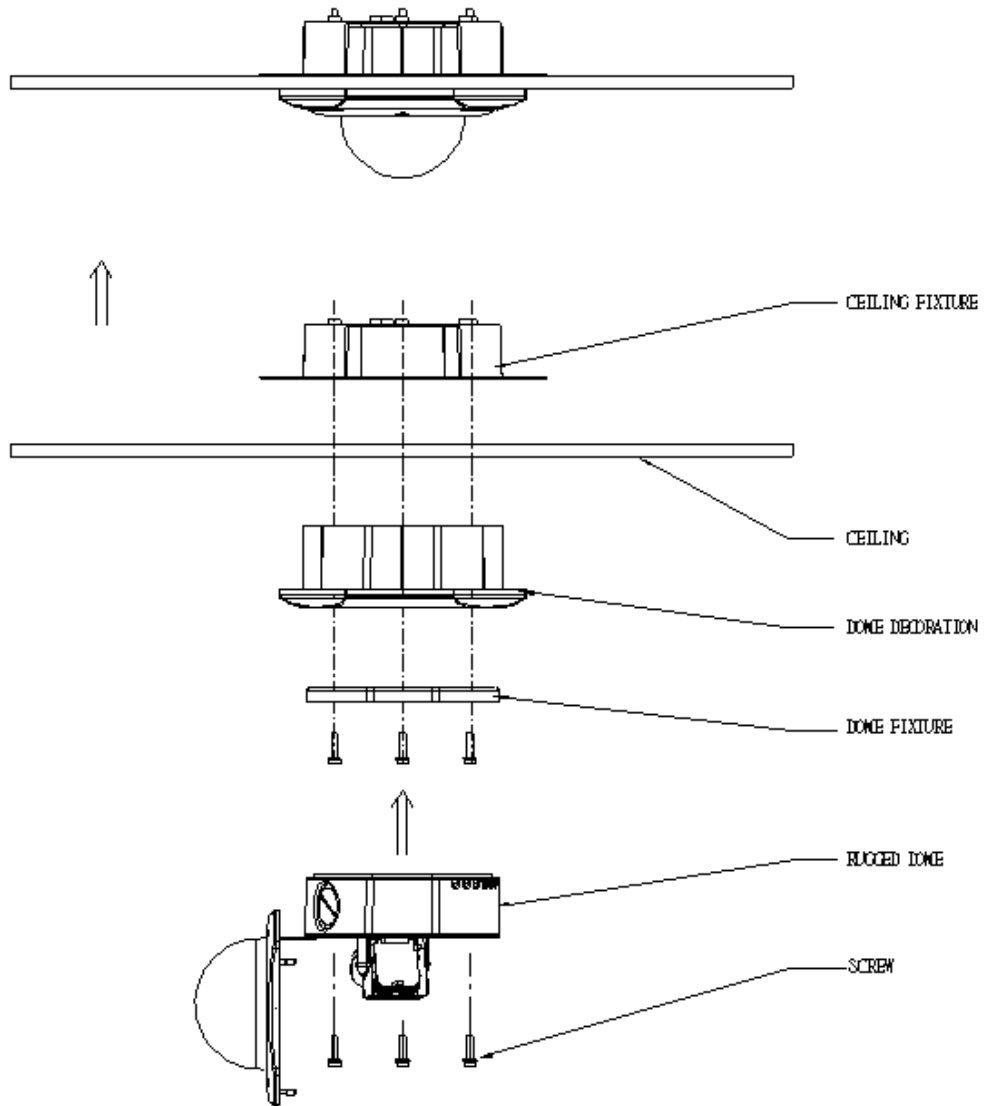

Mount the IP Indoor Dome (Wall)

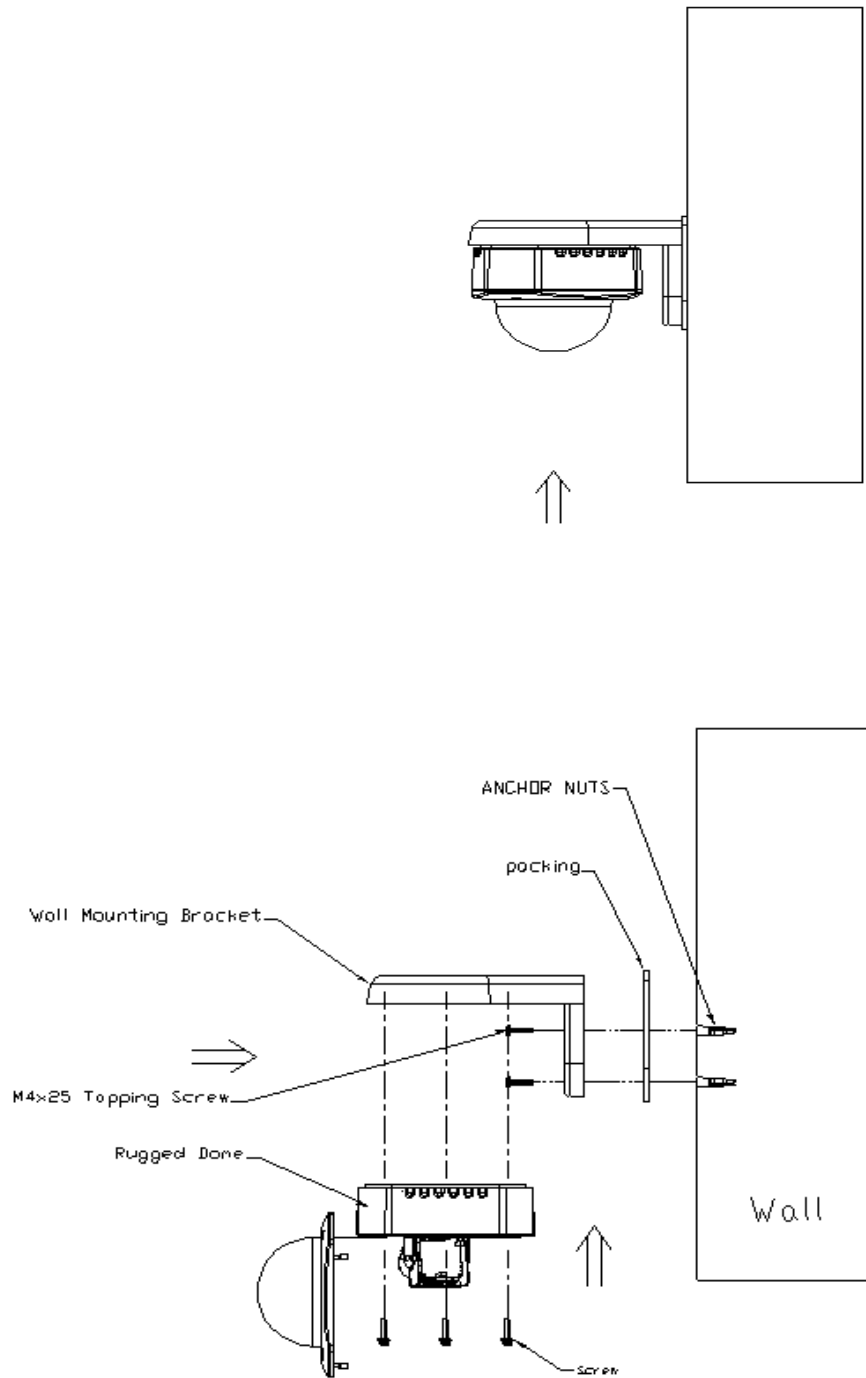

How to Do the Waterproof with Conduit Installation

The following installation procedure makes the camera be water-resistant even for the situations where the camera can easily be flooded by pouring rain.

The important part to focus on during the installation:

The protection of the cabling has to be done by a proper flex conduit (corrugated tubing). The size of conduit hole on camera is **3/4"**, hence the size of the flex conduit that matches with the conduit gland is **3/4"** (trade size), or with actual physical diameter of **26.441mm**.



Please note that the **conduit gland is included to the package** of the outdoor dome camera and the size of the flex conduit that matches with this conduit gland is **3/8"**.

The conduit gland consists of six parts: Lock Nut, Washer(Gasket), Body, Sealing Insert and Clamping Nut as shown below. Lock Nut of this conduit gland is not accessory on our outdoor dome camera.



The following images show the step-by-step procedure of completing the water-proof installation.



1. Disassemble the conduit gland as shown on the photo.



Example – using the side hole



2. Pull the network cable through the flex conduit. Please note that the size of the conduit and the gland is big enough to let the RJ-45 connector pass through all the way, you may also consider to do the RJ-45 connector crimping after pushing the cable through the conduit.
3. Slide the **clamping nut** around flex conduit some 10-20 cm away from the top. Fit the **sealing insert** (made of rubber) to the top of the flex conduit.
4. On the camera side, decide which of the 2 possible holes you are going to use to connect the flex conduit. There is one hole on the side, and one on the bottom. Whichever you pick, remember to seal off the other one with the metal **patch** (included in the camera set).
5. Screw the **body with washer** of the conduit gland into the camera and fix it .



6. Connect the Ethernet cable to the camera's network port.
7. Push the head of the flex conduit, wrapped with sealing insert, into the body of the conduit gland.
8. Screw the clamping nut tightly onto the body of the conduit gland.
9. Adjust the viewing angle and focus of the camera and put the dome cover back on, and tighten it by using the screws.
10. You have completed a fully waterproof installation, the camera is now ready to withstand even the most severe rain storms.

Accessing Camera

Connect the Equipment

To be able to connect to the camera firmware from your PC, both the camera and the PC have to be connected to each other via Ethernet cable. At the same time, the camera has to have its own power supply. In case of PoE cameras, you can use a PoE Injector or a PoE Switch between the camera and the PC. The cameras that have the DC power connectors may be powered on by using a power adaptor.

The Ethernet port LED or Power LED of the camera will indicate that the power supply for the camera works normally.

Configure the IP Addresses

In order to be able to communicate with the camera from your PC, both the camera and the PC have to be within the same network segment. In most cases, it means that they both should have very similar IP addresses, where only the last number of the IP address is different from each other. There are 2 different approaches to IP Address management in Local Area Networks – by DHCP Server or Manually.

Using DHCP server to assign IP addresses:

If you have connected the computer and the camera into the network that has a DHCP server running, then you do not need to configure the IP addresses at all – both the camera and the PC would request a unique IP address from DHCP server automatically. In such case, the camera will immediately be ready for the access from the PC. The user, however, might not know the IP address of the camera yet. It is necessary to know the IP address of the camera in order to be able to access it by using a Web browser.

The quickest way to discover the cameras in the network is to use the simplest network search, built in the Windows system – just by pressing the “Network” icon, all the cameras of the local area network will be discovered by Windows thanks to the UPnP function support of our cameras.

In the example below, we successfully found **D11** camera that we had just connected to the network.

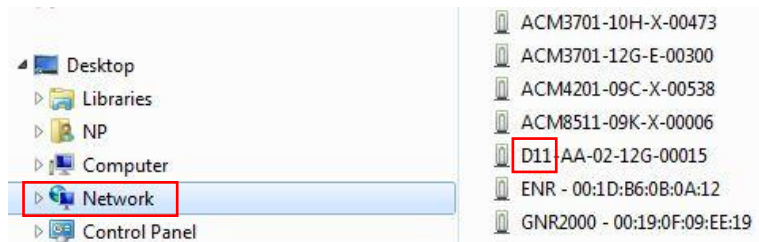

With the left mouse click on D11 it is possible to automatically launch the default browser of the PC with the IP address of the target camera filled in the address bar of the browser already.

If you work with our cameras regularly, then **there is even a better way to discover the cameras in the network** – by using **IP Utility**. The IP Utility is a light software tool that can not only discover the cameras, but also list lots of valuable information, such as IP and MAC addresses, serial numbers, firmware versions, etc, and allows quick configuration of multiple devices at the same time.

The IP Utility can be downloaded for free from http://www.acti.com/IP_Utility

With just 1 click, you can launch the IP Utility and there will be an instant report as follows:

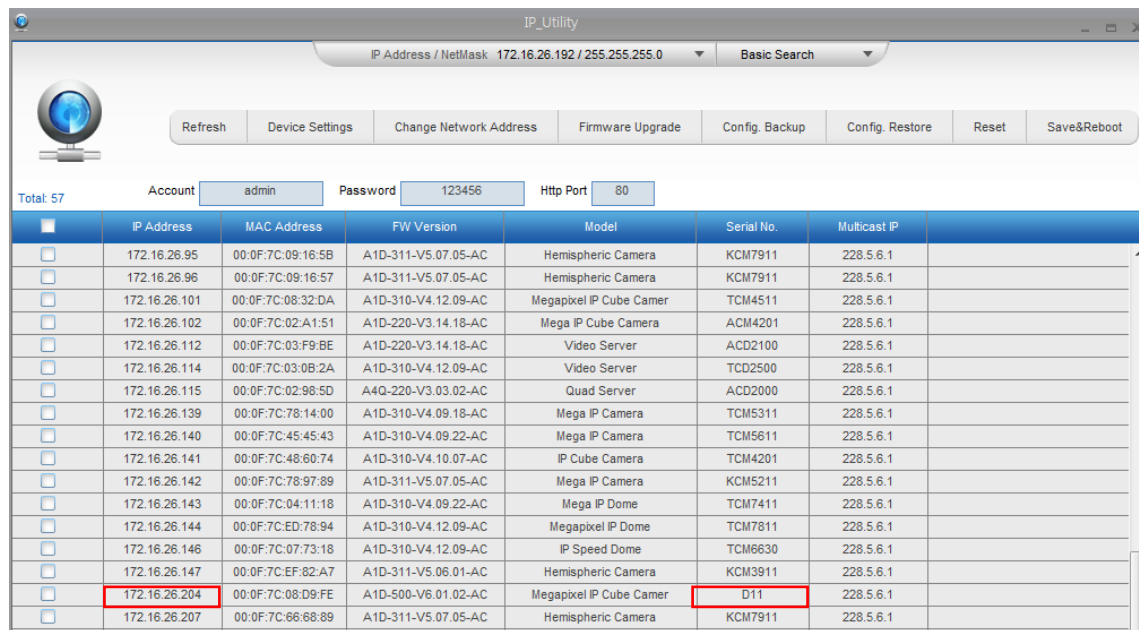

	IP Address	MAC Address	FW Version	Model	Serial No.	Multicast IP
<input type="checkbox"/>	172.16.26.95	00:0F:7C:09:16:5B	A1D-311-V5.07.05-AC	Hemispheric Camera	KCM7911	228.5.6.1
<input type="checkbox"/>	172.16.26.96	00:0F:7C:09:16:57	A1D-311-V5.07.05-AC	Hemispheric Camera	KCM7911	228.5.6.1
<input type="checkbox"/>	172.16.26.101	00:0F:7C:08:32:DA	A1D-310-V4.12.09-AC	Megapixel IP Cube Camer	TCM4511	228.5.6.1
<input type="checkbox"/>	172.16.26.102	00:0F:7C:02:A1:51	A1D-220-V3.14.18-AC	Mega IP Cube Camera	ACM4201	228.5.6.1
<input type="checkbox"/>	172.16.26.112	00:0F:7C:03:F9:BE	A1D-220-V3.14.18-AC	Video Server	ACD2100	228.5.6.1
<input type="checkbox"/>	172.16.26.114	00:0F:7C:03:0B:2A	A1D-310-V4.12.09-AC	Video Server	TCD2500	228.5.6.1
<input type="checkbox"/>	172.16.26.115	00:0F:7C:02:98:5D	A4Q-220-V3.03.02-AC	Quad Server	ACD2000	228.5.6.1
<input type="checkbox"/>	172.16.26.139	00:0F:7C:78:14:00	A1D-310-V4.09.18-AC	Mega IP Camera	TCM5311	228.5.6.1
<input type="checkbox"/>	172.16.26.140	00:0F:7C:45:45:43	A1D-310-V4.09.22-AC	Mega IP Camera	TCM5611	228.5.6.1
<input type="checkbox"/>	172.16.26.141	00:0F:7C:48:60:74	A1D-310-V4.10.07-AC	IP Cube Camera	TCM4201	228.5.6.1
<input type="checkbox"/>	172.16.26.142	00:0F:7C:78:97:89	A1D-311-V5.07.05-AC	Mega IP Camera	KCM5211	228.5.6.1
<input type="checkbox"/>	172.16.26.143	00:0F:7C:04:11:18	A1D-310-V4.09.22-AC	Mega IP Dome	TCM7411	228.5.6.1
<input type="checkbox"/>	172.16.26.144	00:0F:7C:ED:78:94	A1D-310-V4.12.09-AC	Megapixel IP Dome	TCM7811	228.5.6.1
<input type="checkbox"/>	172.16.26.146	00:0F:7C:07:73:18	A1D-310-V4.12.09-AC	IP Speed Dome	TCM6630	228.5.6.1
<input type="checkbox"/>	172.16.26.147	00:0F:7C:EF:82:A7	A1D-311-V5.06.01-AC	Hemispheric Camera	KCM3911	228.5.6.1
<input type="checkbox"/>	172.16.26.204	00:0F:7C:08:D9:FE	A1D-500-V6.01.02-AC	Megapixel IP Cube Camer	D11	228.5.6.1
<input type="checkbox"/>	172.16.26.207	00:0F:7C:66:68:89	A1D-311-V5.07.05-AC	Hemispheric Camera	KCM7911	228.5.6.1

You can quickly notice the **D11** model in the list. Click on the IP address to automatically launch the default browser of the PC with the IP address of the target camera filled in the address bar of the browser already.

Use the default IP address of a camera:

If there is no DHCP server in the given network, the user may have to assign the IP addresses to both PC and camera manually to make sure they are in the same network segment.

When the camera is plugged into network and it does not detect any DHCP services, it will automatically assign itself a default IP:

192.168.0.100

Whereas the default port number would be **80**. In order to access that camera, the IP address of the PC has to be configured to match the network segment of the camera.

Manually adjust the IP address of the PC:

In the following example, based on Windows 7, we will configure the IP address to **192.168.0.99** and set Subnet Mask to **255.255.255.0** by using the steps below:

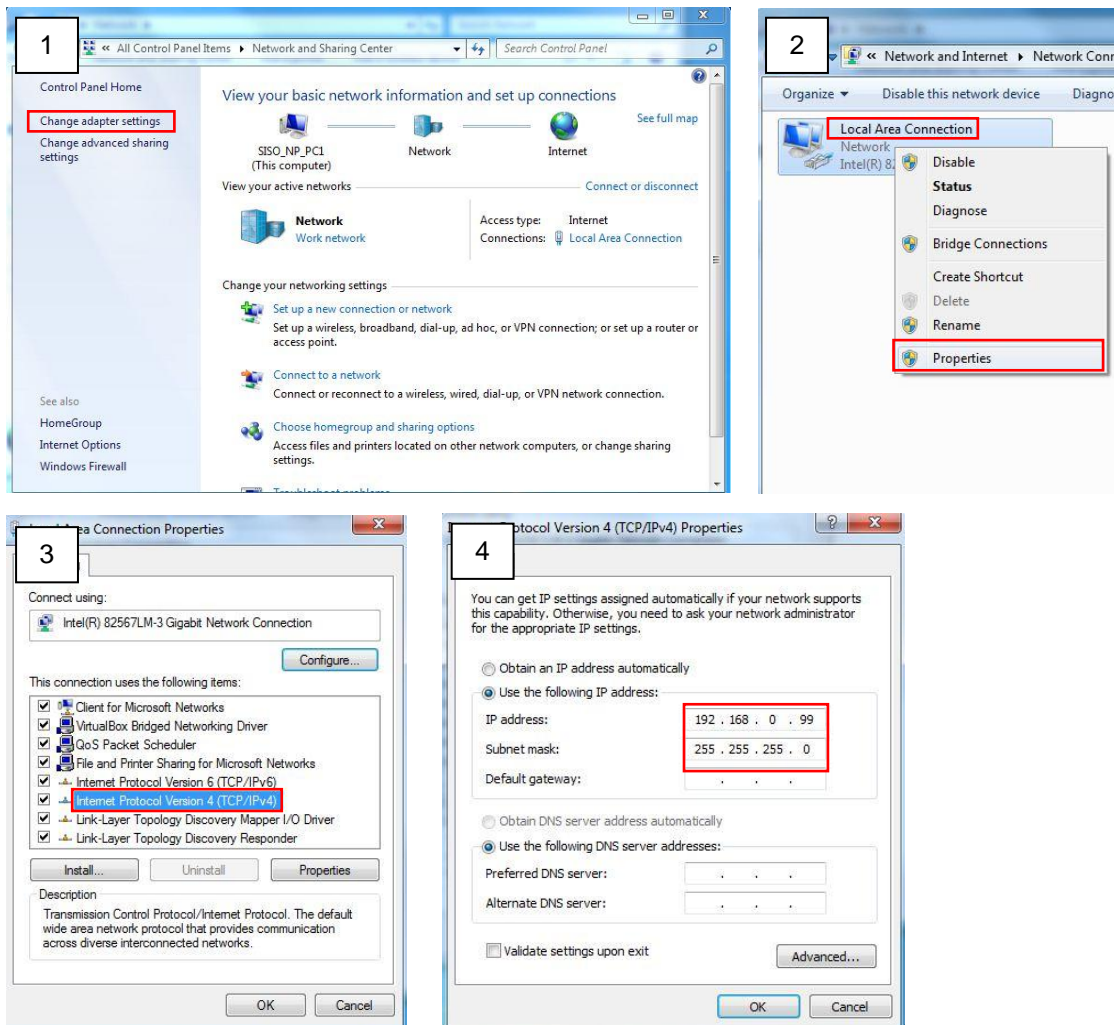

Manually adjust the IP addresses of multiple cameras:

If there are more than 1 camera to be used in the same local area network and there is no DHCP server to assign unique IP addresses to each of them, all of the cameras would then have the initial IP address of **192.168.0.100**, which is not a proper situation for network devices – all the IP addresses have to be different from each other. The easiest way to assign cameras the IP addresses is by using **IP Utility**:

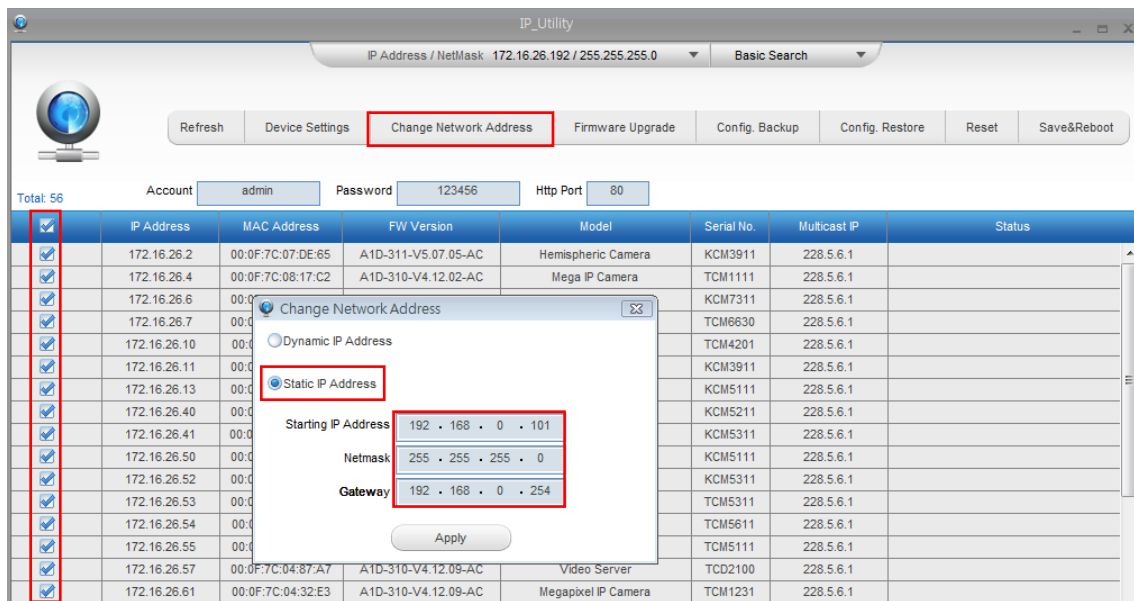

With the procedure shown above, all the cameras will have unique IP addresses, starting from 192.168.0.101. In case there are 20 cameras selected, the last one of the cameras would have the IP 192.168.0.120.

Later, by pressing the “Refresh” button of the IP Utility, you will be able to see the list of cameras with their new IP addresses.

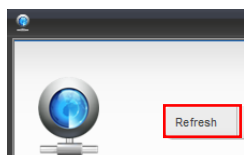

Please note that it is also possible to change the IP addresses manually by using the Web browser. In such case, please plug in only one camera at a time, and change its IP address by using the Web browser before plugging in the next one. This way, the Web browser will not be confused about two devices having the same IP address at the same time.

Access the Camera

Now that the camera and the PC are both having their unique IP addresses and are under the same network segment, it is possible to use the Web browser of the PC to access the camera.

You can use **any of the browsers** to access the camera, however, the full functionality is provided only for **Microsoft Internet Explorer**.

The browser functionality comparison:

Functionality	Internet Explorer	Other browsers
Live Video	Yes	Yes*
Live Video Area Resizable	Yes	No
PTZ Control	Yes	Yes
Capture the snapshot	Yes	Yes
Video overlay based configuration (Motion Detection regions, Privacy Mask regions)	Yes	No
All the other configurations	Yes	Yes

* The basic **VLC media player** (<http://www.videolan.org>) has to be installed in PC first before using any non-Internet Explorer browsers to be able to get live video feed from the camera with those browsers. It is a free and open source cross-platform multimedia player.

Disclaimer Notice: The camera manufacturer does not guarantee the compatibility of its cameras with VLC player – since it is a third party software, the third party has the right to modify their utility any time which might affect the compatibility. In such cases, please use Internet Explorer browser instead.

When using Internet Explorer browser, the ActiveX control for video stream management will be downloaded from the camera directly – the user just has to accept the use of such control when prompted so. No other third party utilities are required to be installed in such case.

The following examples in this manual are based on Internet Explorer browser in order to cover all functions of the camera.

Assuming that the camera's IP address is **192.168.0.100**, you can access it by opening the Web browser and typing the following address into Web browser's address bar:

http://192.168.0.100

Upon successful connection to the camera, the user interface called **Web Configurator** would appear together with the login page. The HTTP port number was not added behind the IP address since the default HTTP port of the camera is 80, which can be omitted from the address for convenience.

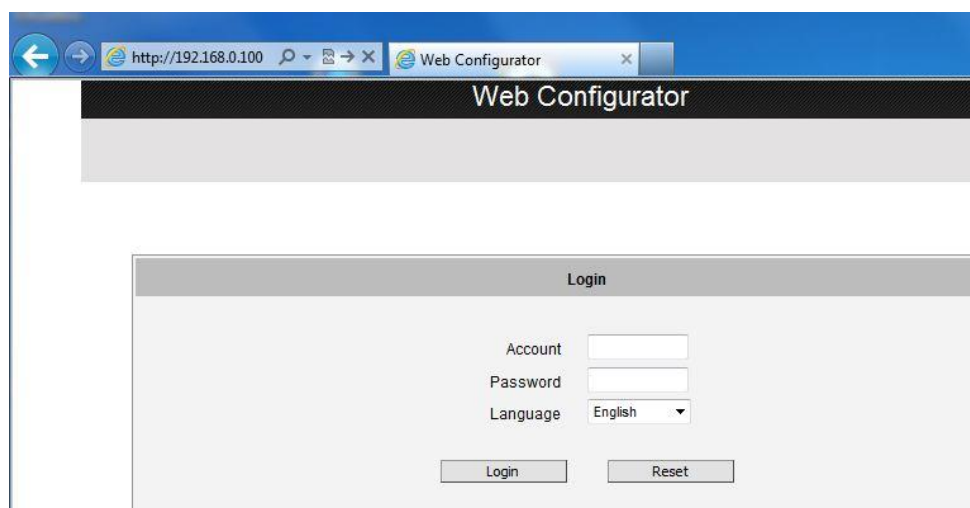

Before logging in, you need to know the factory default Account and Password of the camera.

Account: **Admin**

Password: **123456**

For further operations, please refer to the **Firmware User Manual**.