

Face Recognition Access Controller

User's Manual

V1.0.3

General

This manual introduces the installation and basic operation of the Face Recognition Access Controller (hereinafter referred to as "access controller").

Safety Instructions

The following categorized signal words with defined meaning might appear in the manual.

Signal Words	Meaning
 NOTE	Provides additional information as the emphasis and supplement to the text.

Revision History

Version	Revision Content	Release Date
V1.0.3	Updated the manual.	October 2022
V1.0.2	Add touch screen notes to the related content.	August 2020
V1.0.0	First Release.	August 2019

About the Manual

- The manual is for reference only. If there is inconsistency between the manual and the actual product, the actual product shall prevail.
- We are not liable for any loss caused by the operations that do not comply with the manual.
- The manual would be updated according to the latest laws and regulations of related regions. For detailed information, see the paper manual, CD-ROM, QR code or our official website. If there is inconsistency between paper manual and the electronic version, the electronic version shall prevail.
- All the designs and software are subject to change without prior written notice. The product updates might cause some differences between the actual product and the manual. Please contact the customer service for the latest program and supplementary documentation.
- There still might be deviation in technical data, functions and operations description, or errors in print. If there is any doubt or dispute, please refer to our final explanation.
- Upgrade the reader software or try other mainstream reader software if the manual (in PDF format) cannot be opened.
- All trademarks, registered trademarks and the company names in the manual are the properties of their respective owners.
- Please visit our website, contact the supplier or customer service if there is any problem occurred when using the device.
- If there is any uncertainty or controversy, please refer to our final explanation.

Important Safeguards and Warnings

This Chapter describes the contents covering proper handling of the access controller, hazard prevention, and prevention of property damage. Read these contents carefully before using the access controller, comply with them when using, and keep it well for future reference.

Operation Requirement

- Do not place or install the access controller in a place exposed to sunlight or near the heat source.
- Keep the access controller away from dampness, dust or soot.
- Keep the access controller installed horizontally on the stable place to prevent it from falling.
- Do not drop or splash liquid onto the access controller, and make sure there is no object filled with liquid on the access controller to prevent liquid from flowing into the access controller.
- Install the access controller in a well-ventilated place, and do not block the ventilation of the access controller.
- Operate the access controller within the rated range of power input and output.
- Do not disassemble the access controller.
- Transport, use and store the access controller under the allowed humidity and temperature conditions.

Electrical Safety

- Improper battery use might result in fire, explosion, or inflammation.
- When replacing battery, make sure the same model is used.
- Use the recommended power cables in the region and conform to the rated power specification.
- Use the power adapter provided with the access controller; otherwise, it might result in people injury and device damage.
- The power source shall conform to the requirement of the Safety Extra Low Voltage (SELV) standard, and supply power with rated voltage which conforms to Limited power Source requirement according to IEC60950-1. Please note that the power supply requirement is subject to the device label.
- Connect the device (I-type structure) to the power socket with protective earthing.
- The appliance coupler is a disconnection device. When using the coupler, keep the angle for easy operation.

Table of Contents

Foreword	I
Important Safeguards and Warnings	II
1 Overview	1
1.1 Introduction	1
1.2 Features	1
1.3 Dimension and Component	1
2 Installation	6
2.1 Cable Connections.....	6
2.2 Installation	7
3 System Operation	9
3.1 Initialization.....	9
3.2 Standby Interface.....	9
3.3 Unlocking Methods.....	11
3.3.1 Cards.....	11
3.3.2 Face	11
3.3.3 Fingerprints.....	11
3.3.4 User Passwords	11
3.3.5 Administrator Password	12
3.4 Main Menu.....	12
3.5 User Management	14
3.5.1 Adding New Users	14
3.5.2 Viewing User information	16
3.6 Access Management.....	16
3.6.1 Period Management.....	17
3.6.2 Unlock	18
3.6.3 Alarm Configuration	21
3.6.4 Door Status.....	22
3.6.5 Lock Holding Time	22
3.7 Network Communication	22
3.7.1 IP Address	23
3.7.2 Serial Port Settings	24
3.7.3 Wiegand Configuration	24
3.8 System	25
3.8.1 Time.....	25
3.8.2 Face Parameter	26
3.8.3 Fill Light Mode Setting.....	26
3.8.4 Fill Light Brightness Setting	27
3.8.5 Volume Adjustment	27
3.8.6 IR Light Brightness Adjustment.....	27
3.8.7 FP Parameter.....	27
3.8.8 Restore to Factory Settings	27

3.8.9 Reboot.....	27
3.9 USB	27
3.9.1 USB Export.....	28
3.9.2 USB Import	28
3.9.3 USB Update	29
3.9.4 Features	29
3.9.5 Privacy Setting	31
3.9.6 Result Feedback	32
3.10 Record.....	34
3.11 Auto Test	35
3.12 System Info	36
4 Web Operation.....	37
4.1 Initialization.....	37
4.2 Login	38
4.3 Reset the Password.....	39
4.4 Alarm Linkage	41
4.4.1 Setting Alarm Linkage.....	41
4.4.2 Alarm Log.....	43
4.5 Data Capacity.....	43
4.6 Video Setting	44
4.6.1 Data rate.....	44
4.6.2 Image.....	45
4.6.3 Exposure.....	46
4.6.4 Motion Detection.....	47
4.6.5 Volume Setting	48
4.6.6 Image Mode.....	49
4.7 Face Detect.....	49
4.8 Network Setting.....	51
4.8.1 TCP/IP	51
4.8.2 Port.....	53
4.8.3 P2P.....	54
4.9 Safety Management.....	55
4.9.1 IP Authority	55
4.9.2 Systems.....	56
4.9.3 User Management	56
4.9.4 Maintenance	57
4.9.5 Configuration Management.....	57
4.9.6 Upgrade.....	58
4.9.7 Version Information	58
4.9.8 Online User.....	58
4.10 System Log.....	59
4.10.1 Query Logs.....	59
4.10.2 Backup Logs	59
4.11 Admin Log.....	59
4.12 Exit.....	60
5 Smart PSS Configuration	61
5.1 Login.....	61

5.2 Add Devices	61
5.2.1 Auto Search	61
5.2.2 Manual Add	62
5.3 Add Users	63
5.3.1 Card Type Selection	64
5.3.2 Adding One User	65
5.4 Adding Door Group	66
5.5 Access Permission Configuration	68
5.5.1 Giving Permission by Door Group	68
5.5.2 Giving Permission by User ID	70
Appendix 1 Cybersecurity Recommendations	72

1.1 Introduction

The access controller is an access control panel that supports unlock through faces, passwords, fingerprints, cards, and supports unlock through their combinations.

1.2 Features

- Support face unlock, IC card unlock, fingerprint unlock, and password unlock; unlock by period
- With face detection box; the largest face among faces that appear at the same time is recognized first; the maximum face size can be configured on the web
- 2MP wide-angle WDR lens; with auto/manual fill light
- Face-camera distance: 0.3 m–2.0 m; human height: 0.9 m–2.4 m
- With face recognition algorithm, the terminal can recognize more than 360 positions on human face
- Face verification accuracy>99.5%; low false recognition rate
- Support profile recognition; the profile angle is 0°–90°
- Support liveness detection
- Support duress alarm and tamper alarm
- Support general users, duress users, patrol users, blocklist users, VIP users, guest users, and the disabled users
- With 4 unlock status display modes and various voice prompt modes

1.3 Dimension and Component

The access controller has two types: 7-inch and 10-inch access controllers. See Figure 1-1 to Figure 1-4.

7-Inch Access Controller

Figure 1-1 Dimensions and components (1) (mm [inch])

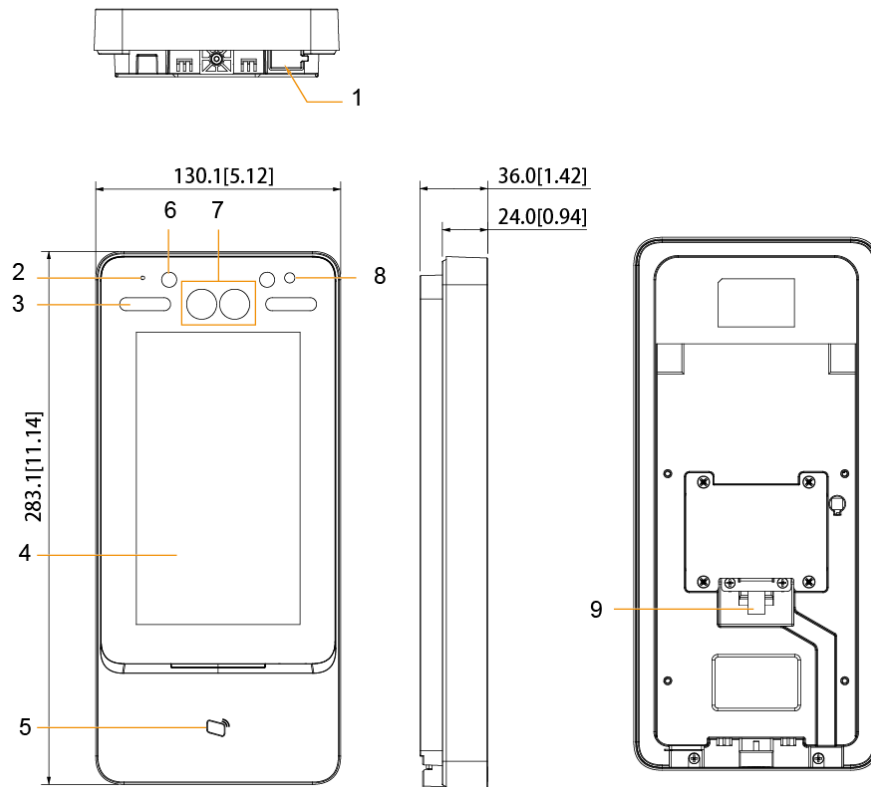

Table 1-1 Component description (1)

No.	Name	No.	Name
1	USB port	6	IR light
2	MIC	7	Dual camera
3	White fill light	8	Phototransistor
4	Display	9	Cable entry
5	Card swiping area	-	-

Figure 1-2 Dimensions and components (2) (mm [inch])

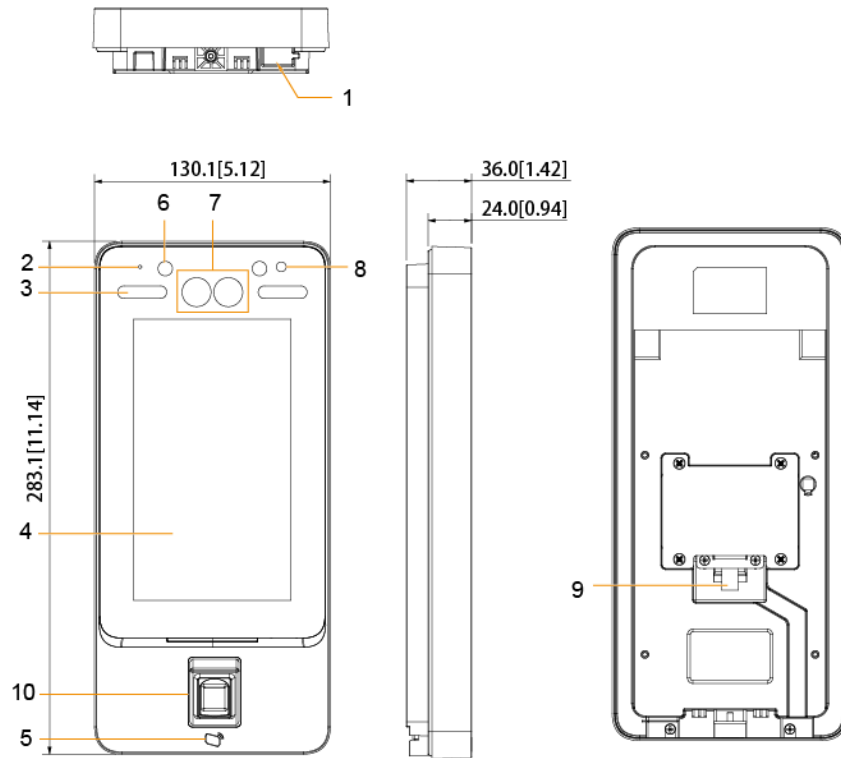

Table 1-2 Component description (2)

No.	Name	No.	Name
1	USB port	6	IR light
2	MIC	7	Dual camera
3	White fill light	8	Phototransistor
4	Display	9	Cable entry
5	Card swiping area	10	Fingerprint sensor

10-Inch Access Controller

Figure 1-3 Dimensions and components (3) (mm [inch])

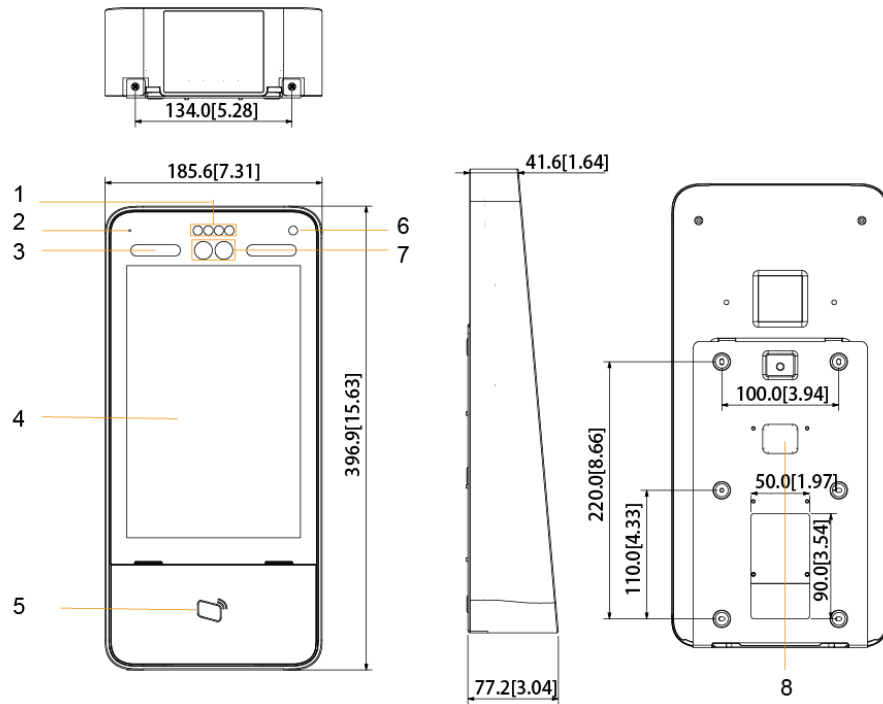

Table 1-3 Component description (3)

No.	Name	No.	Name
1	IR light	6	Phototransistor
2	MIC	7	Dual camera
3	White fill light	8	Cable entry
4	Display	9	–
5	Card swiping area	10	–

Figure 1-4 Dimensions and components (4) (mm [inch])

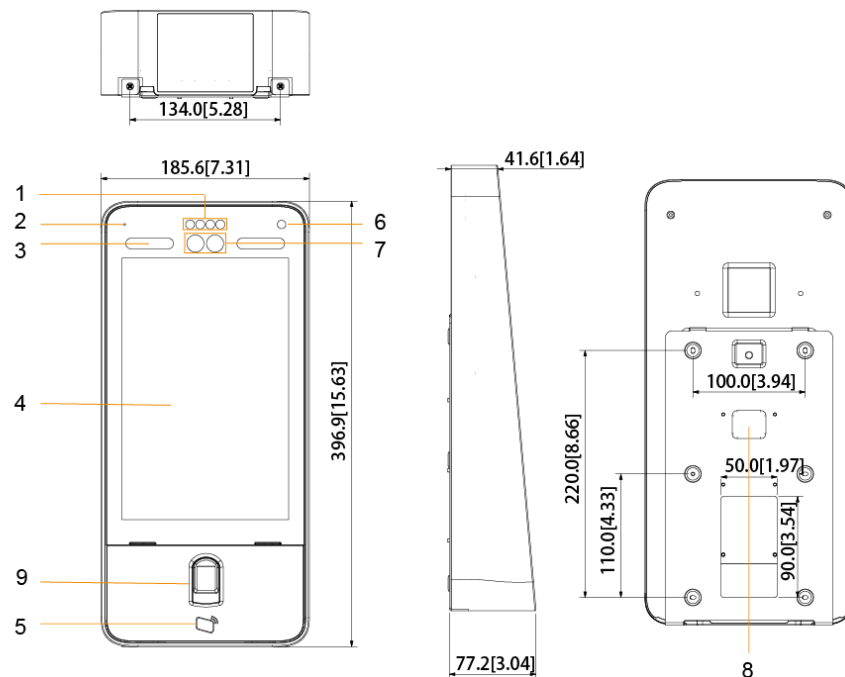

Table 1-4 Component description (4)



No.	Name	No.	Name
1	IR light	6	Phototransistor
2	MIC	7	Dual camera
3	White fill light	8	Cable entry
4	Display	9	Fingerprint sensor
5	Card swiping area	10	–

2 Installation

2.1 Cable Connections

The access controller needs to be connected to devices like sirens, readers, and door contacts. For cable connection, see Table 2-1.

Table 2-1 Port description

Port	Cable color	Cable name	Description
CON1	Black	RD-	Negative electrode of external card reader power supply.
	Red	RD+	Positive electrode of external card reader power supply.
	Blue	CASE	Tamper alarm input of the external card reader.
	White	D1	Wiegand D1 input (connected to external card reader)/output (connected to controller).
	Green	D0	Wiegand D0 input (connected to external card reader)/output (connected to controller).
	Brown	LED	Connected to external reader indicator in
	Yellow	B	RS-485 negative electrode input (connected to external card reader)/output (connected to controller, or connected to door control security module).  <ul style="list-style-type: none"> If the security module is enabled, you need to purchase access control security module separately. The security module needs separate power supply to provide power. Once the security module is enabled, the exit button, lock control and firefighting linkage will be invalid.
	Purple	A	RS-485 positive electrode input (connected to external card reader)/output (connected to controller, or connected to door control security module).  <ul style="list-style-type: none"> If the security module is enabled, you need to purchase access control security module separately. The security module needs separate power supply to provide power. Once the security module is enabled, the exit button, lock control and firefighting linkage will be invalid.

Port	Cable color	Cable name	Description
CON2	White and red	ALARM1_NO	Alarm 1 normally open output port.
	White and orange	ALARM1_COM	Alarm 1 common output port.
	White and blue	ALARM2_NO	Alarm 2 normally open output port.
	White and gray	ALARM2_COM	Alarm 2 common output port.
	White and green	GND	Connected to the common GND port.
	White Brown	ALARM1	Alarm 1 input port.
	White and yellow	GND	Connected to the common GND port.
	White and purple	ALARM2	Alarm 2 input port.
CON3	Black and red	RX	RS-232 receiving port.
	Black and orange	TX	RS-232 sending port.
	Black and blue	GND	Connected to the common GND port.
	Black and gray	SR1	Used for door contact detection.
	Black and green	PUSH1	Door open button of door No.1
	Black and brown	DOOR1_COM	Lock control common port.
	Black and yellow	DOOR1_NO	Lock control normally open port.
	Black and purple	DOOR1_NC	Lock control normally closed port.

2.2 Installation

Installation methods of all controllers are the same. Make sure that the distance between the lens and ground is 1.4 meters. See Figure 2-1.

Figure 2-1 Installation height

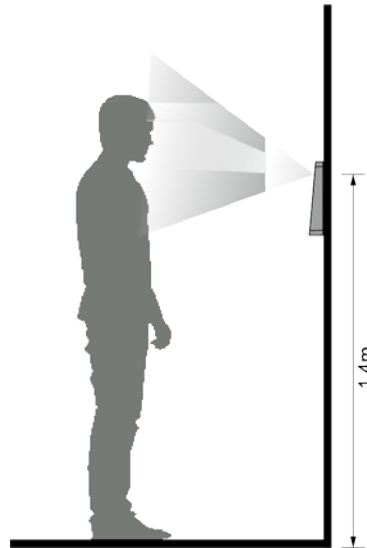
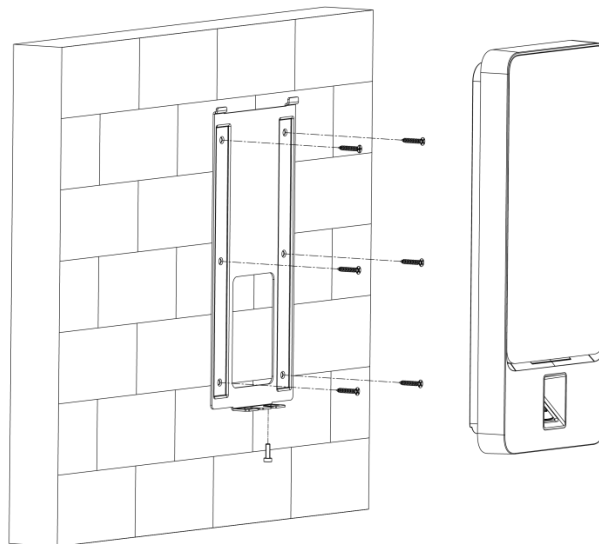

Figure 2-2 Installation diagram



Installation Procedure

- Step 1** Drill seven holes (six bracket installation holes and one cable entry) in the wall according to holes in the bracket.
- Step 2** Fix the bracket on the wall by installing the expansion screws into the six bracket installation holes.
- Step 3** Connect cables for access controller.
See "2.1 Cable Connections."
- Step 4** Hang the access controller on the bracket hook.
- Step 5** Tighten the screws at the bottom of the access controller.
- Step 6** The installation is completed.

3 System Operation



Some operations are supported only by the access controller with touch screen. The actual product shall prevail.

3.1 Initialization (Touch Screen Only)

Administrator password and an email should be set the first time the access controller is turned on; otherwise the access controller cannot be used.

Figure 3-1 Initialization

Device Initialization

Admin admin

PWD

PWD Confirm

E-mail

Yes Clear



- Administrator and password set on this interface are used to log in to the web management platform.
- The administrator password can be reset through the email address you entered if the administrator forgets the administrator password.
- The password should consist of 8 to 32 non-blank characters and contain at least two types of characters among upper case, lower case, number, and special character (excluding ' " ; : &).

3.2 Standby Interface

You can unlock the door through faces, passwords, cards and fingerprints. See Table 3-1.



If there are no operations in 30 seconds, the access controller will go to the standby mode.

Figure 3-2 Homepage

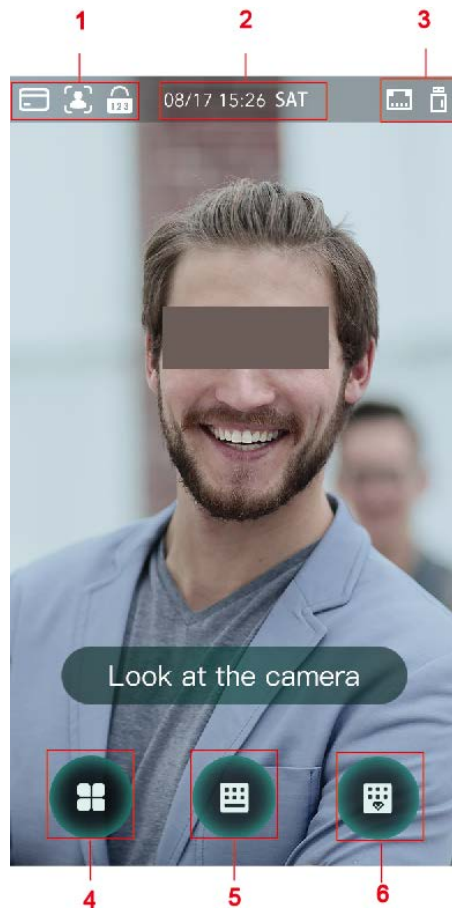





Table 3-1 Homepage description

No.	Description
1	<p>Unlock methods: Card, face, fingerprint, and password.</p>  <p>When card, face, fingerprint, and password are all set as unlock mode, the password icon will not be displayed at the top left corner of the access controller.</p>
2	Date & Time: Current date and time is displayed here.
3	Network status and USB status are displayed here.
4	<p>Main menu icon.</p>  <ul style="list-style-type: none"> • Only the administrator can enter the main menu. • Only the access controller with touch screen supports this function.
5	<p>Password unlock icon.</p>  <p>Only the access controller with touch screen supports this function.</p>
6	<p>Administrator password unlock icon.</p>  <p>Only the access controller with touch screen supports this function.</p>

3.3 Unlocking Methods

You can unlock the door through faces, passwords, fingerprints, and cards.

3.3.1 Cards

Put the card at the card swiping area to unlock the door.

3.3.2 Face

Make sure that your face is centered on the face recognition frame, and then you can unlock the door.

3.3.3 Fingerprints

Place your fingerprint at the fingerprint sensor to unlock the door.

3.3.4 User Passwords (Touch Screen Only)

Enter the user passwords, and then you can unlock the door.

Step 1 Tap  on the homepage.

Step 2 Enter the User ID, and then tap .

Step 3 Enter the User password, and then tap .

The door is unlocked.

3.3.5 Administrator Password (Touch Screen Only)

Enter the administrator password, and then you can unlock the door. There is only one administrator password for one access controller. The administrator password can unlock the door without being subject to user levels, unlock modes, periods, holiday plans, and anti-passback.



Administrator password cannot be used when NC is selected at "3.6.1.5 NC Period."

Step 1 Tap  on the homepage.

Step 2 Tap **Please Enter Administrator PWD.**

Step 3 Enter the administrator password, and then tap .

The door is unlocked.

3.4 Main Menu (Touch Screen Only)

Administrators can add users of different levels, set access-related parameters, do network configuration, view access records and system information, and more in the main menu.

Step 1 Tap  on the standby interface.

The **Administrator Login** interface is displayed.



Different modes support different unlock methods, and the actual interface shall prevail.

Figure 3-3 Administrator login

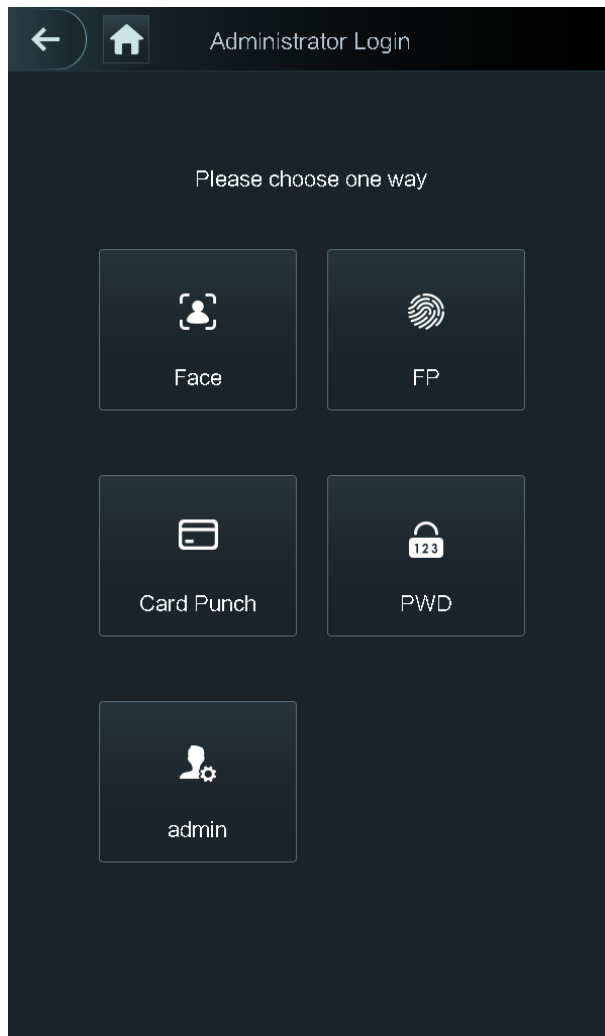

Step 2 Select a main menu entering method.
The main menu interface is displayed.

Figure 3-4 Main Menu

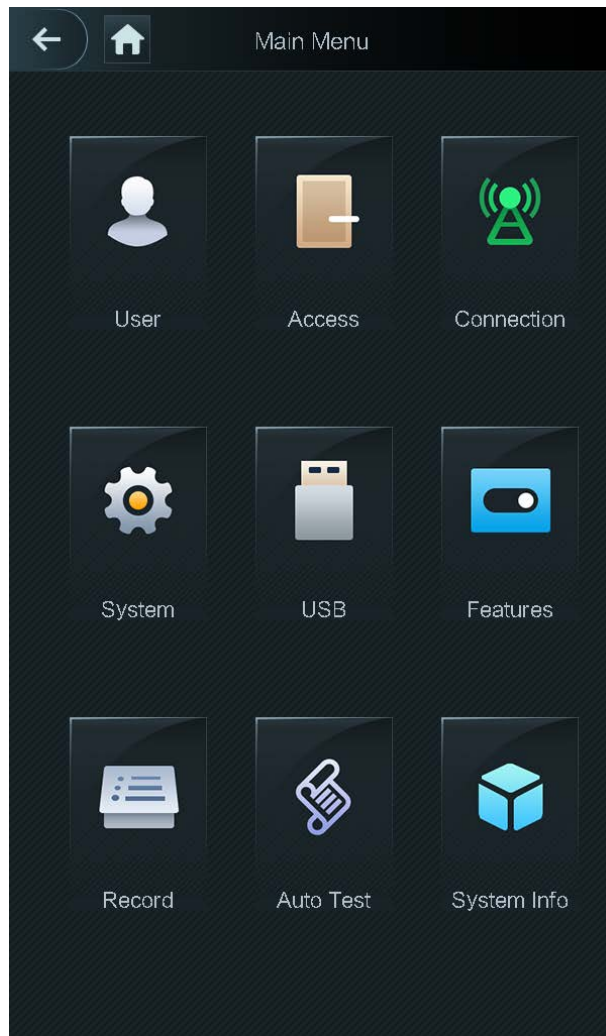

3.5 User Management (Touch Screen Only)

You can add new users, view user lists, admin lists, and modify the administrator password on the **User** interface.

3.5.1 Adding New Users

You can add new users by entering user IDs, names, importing fingerprints, face images, cards, passwords, selecting user levels, and more.



The following figures are for reference only, and the actual interface shall prevail.

Step 1 Select **User > New User**.

The **New User Info** interface is displayed. See Figure 3-5.

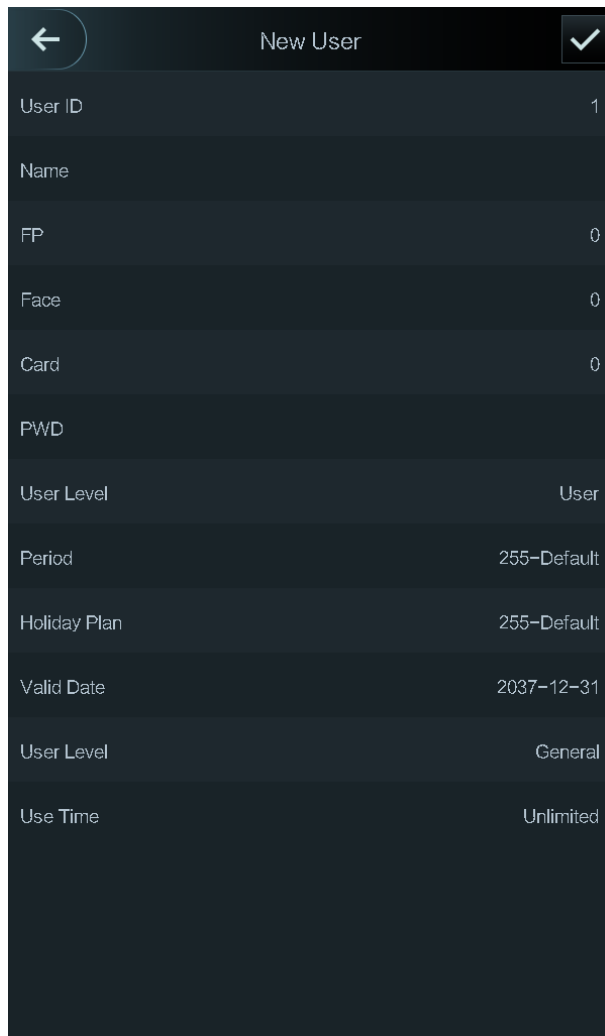

Figure 3-5 New User Info



Step 2 Configure parameters on the interface. See Table 3-2.

Table 3-2 New user parameter description

Parameter	Description
User ID	You can enter user IDs. The IDs can be numbers, letters, and their combinations, and the maximum length of the ID is 32 characters.
Name	You can enter names with at most 32 characters (including numbers, symbols, and letters).
FP	<p>At most three fingerprints of one user can be recorded, and one fingerprints need to be verified three times.</p> <p>You can enable the Duress FP function under each fingerprint, and only one of the three fingerprints can be the duress fingerprint. Alarms will be triggered if a duress fingerprint is used to unlock the door.</p>  <p>It is not recommended that you select the first fingerprint as the duress fingerprint.</p>
Face	Make sure that your face is centered on the picture capturing frame and the access controller will take a picture of the new user's face automatically. For details, see the <i>Quick Start Guide</i> .

Parameter	Description
Card	<p>You can register five cards for each user. On the card registration interface, enter your card number or swipe your card, and then the card information will be read by the access controller.</p> <p>You can enable the Duress Card function on the card registration interface. Alarms will be triggered if a duress card is used to unlock the door.</p>  <p>Only certain models support card unlock.</p>
PWD	The door unlocking password. The maximum length of the ID digits is 8.
User Level	<p>You can select a user level for new users. There are two options:</p> <ul style="list-style-type: none"> ● User: Users only have door unlock authority. ● Admin: Administrators can not only unlock the door but also have parameter configuration authority.  <p>No matter whether there is an administrator in the access controller, administrator identity authentication is needed.</p>
Period	You can set a period in which the user can unlock the door.
Holiday Plan	You can set a holiday plan in which the user can unlock the door.
Valid Date	You can set a period during which the unlocking information of the user is valid.
User Level	<p>There are six levels:</p> <ul style="list-style-type: none"> ● General: General users can unlock the door normally. ● Blocklist: When users in the blocklist unlock the door, service personnel will get a prompt. ● Guest: Guests are allowed to unlock the door certain times. Once they exceed the maximum times, they cannot unlock the door again. ● Patrol: Paroling users can get their attendance tracked, but they have no unlock authority. ● VIP: When VIP unlocks the door, service personnel will get a prompt. ● Disable: When the disabled unlock the door, there will be a delay of 5 seconds before the door is closed.
Use Time	When the user level is Guest, you can set the maximum number of times that the user can unlock the door.

Step 3 After you have configured all the parameters, tap  to save the configuration.

3.5.2 Viewing User information

You can view user list, admin list and enable administrator password through the User interface.

3.6 Access Management (Touch Screen Only)

You can do access management on period, unlock mode, alarm, door status, and lock holding time.

Tap **Access** to go to the access management interface.

3.6.1 Period Management

You can set periods, holiday periods, holiday plan periods, door normally on periods, door normally closed periods, and remote verification periods.

3.6.1.1 Period Config

You can configure 128 periods (weeks) whose number range is 0–127. You can set four periods on each day of a period (week). Users can only unlock the door in the periods that you set.

3.6.1.2 Holiday Group

You can set group holidays, and then you can set plans for holiday groups. You can configure 128 groups whose number range is 0–127. You can add 16 holidays into a group. Configure the start time and end time of a holiday group, and then users can only unlock the door in the periods that you set.



You can enter names with 32 characters (including numbers, symbols, and letters). Tap  to save the holiday group name.

3.6.1.3 Holiday Plan

You can add holiday groups into holiday plans. You can use holiday plans to manage user access authority in different holiday groups. Users can only unlock the door in the period that you set.

3.6.1.4 NO Period

If a period is added to the NO period, then the door is normally open in that period.



The NO/NC period permissions are higher than permissions in other periods.

3.6.1.5 NC Period

If a period is added to the NC period, then the door is normally closed in that period. Users can not unlock the door in this period.

3.6.1.6 Remote Verification Period

If you configured the remote verification period, then when unlock doors during the period you configured, remote verification is required. To unlock the door in this period, a door unlock instruction sent by the management platform is needed.



You need to enable the Remote Verification Period.

-  means enabled.

-  means not enabled.

3.6.2 Unlock

There are three unlock modes: unlock mode, unlock by period, and group combination. Unlock modes vary with controller access models, and the actual controller access shall prevail.

3.6.2.1 Unlock Mode

When the **Unlock Mode** is on, users can unlock through cards, fingerprints, faces, passwords, or any one of all the unlocking methods.

Step 1 Select **Assess > Unlock Mode > Unlock Mode**.

The **Element (Multiple Choice)** interface is displayed. See Figure 3-6.

Figure 3-6 Element (multiple choice)

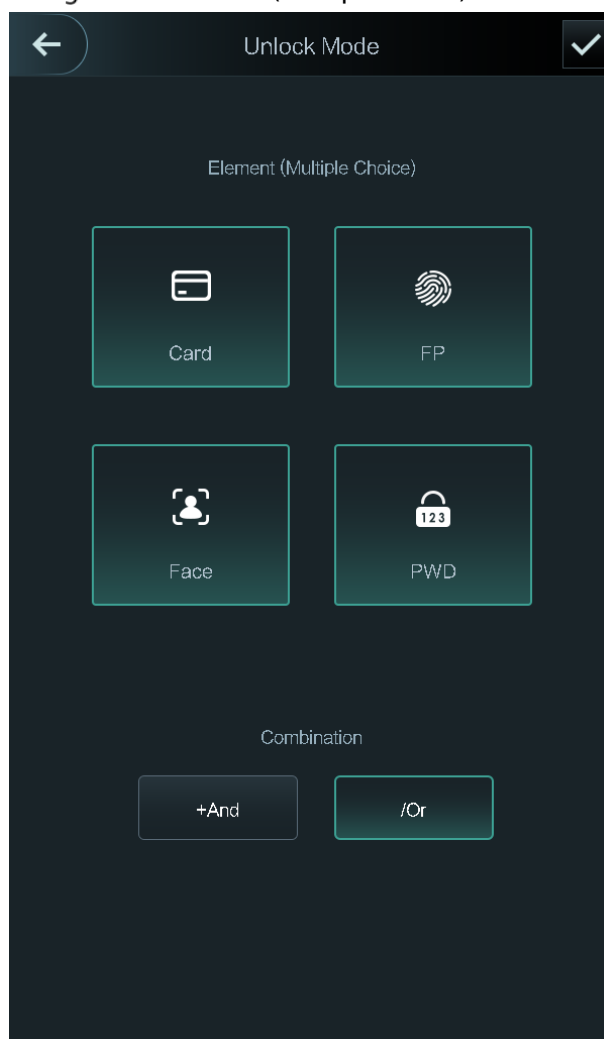

Step 2 Select unlock mode(s).



Tap a selected unlock mode again, the unlock mode will be deleted.

Step 3 Select a combination mode.



- **+ And** means "and". For example, if you selected card + FP, it means, to unlock the door, you need to swipe your card first, and then get your fingerprint scanned.

- / **Or** means "or". For example, if you selected card/FP, it means, to unlock the door, you can either swipe your card or get your fingerprints scanned.

Step 4 Tap  to save the settings.

And then the **Unlock Mode** interface is displayed.

Step 5 Enable the Unlock Mode.

-  means enabled.
-  means not enabled.

3.6.2.2 Unlock by Period

Doors can be unlocked through different unlock modes in different periods. For example, in period 1, the door can only be unlocked through card; and in period 2, doors can only be unlocked through fingerprints.

Step 1 Select Assess > Unlock Mode > Unlock by Period.

The **Unlock Config by Period** interface is displayed. See Figure 3-7.

Figure 3-7 Unlock by period

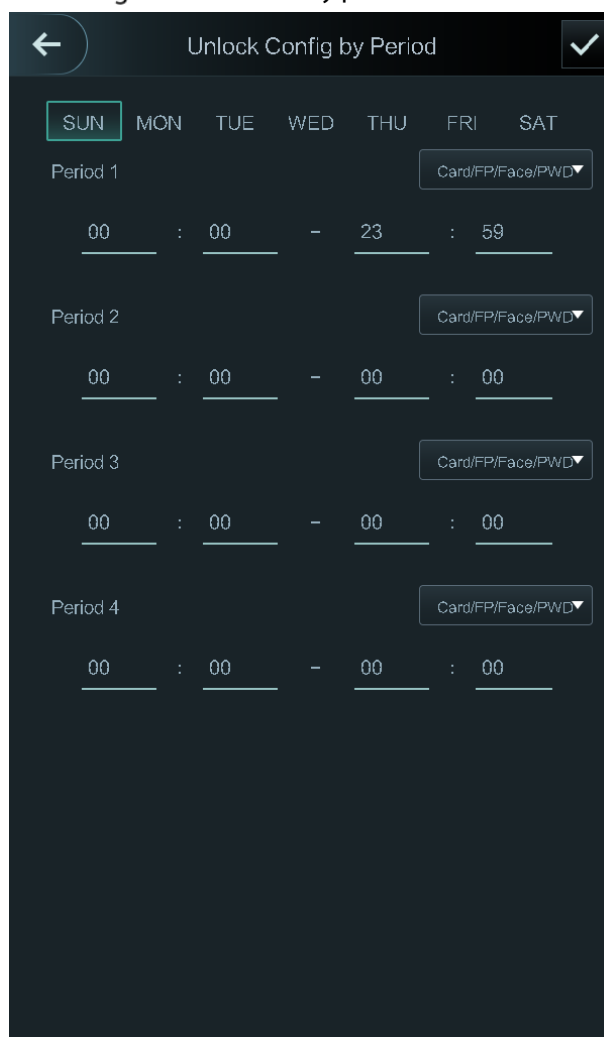



Step 2 Set starting time and end time for a period, and then select a unlock mode.

Step 3 Tap  to save the settings.

The **Unlock Mode** interface is displayed.

Step 4 Enable the Unlock by Period function.

-  means enabled.
-  means not enabled.

3.6.2.3 Group Combination

Doors can only be unlocked by a group or groups that consist of more than two users if the Group Combination is enabled.

Step 1 Select **Assess > Unlock Mode > Group Combination**.

The **Group Combination Config** interface is displayed. See Figure 3-8.

Figure 3-8 Group Combination

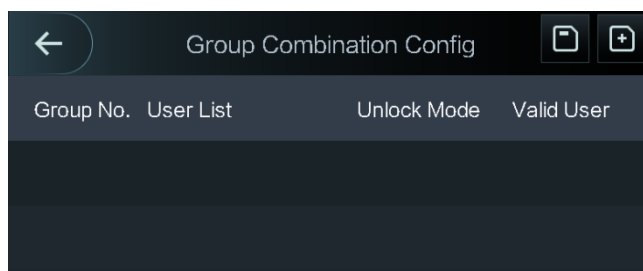

Step 2 Tap  to create a group.

The **Add Group** interface is displayed. See Figure 3-9.

Figure 3-9 Add a group

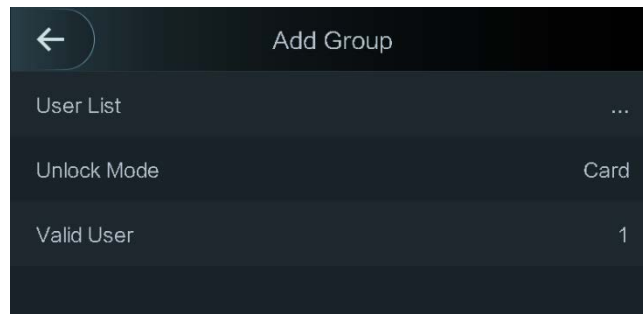





Table 3-3 Group parameter

Parameter	Description
User List	<p>Add users to the newly created group.</p> <ol style="list-style-type: none"> 1. Tap User List. The User List interface is displayed. 2. Tap , and then enter a user ID. 3. Tap  to save the settings.
Unlock Mode	There are four options: Card, FP, PWD and Face .
Valid User	<p>Valid users are the ones that have unlock authority. Doors can be unlocked only when the number of users to unlock the doors equals the valid user number.</p> <ul style="list-style-type: none"> • Valid users cannot exceed the total number of users in a group. • If valid users equal total user numbers in a group, doors can only be unlocked by all the users in the group. • If valid users are less than the total number of users in a group, doors can be unlocked by any users whose number equals the valid user number.

Step 3 Tap  to go back to the previous interface.

Step 4 Tap  to save the settings.

Step 5 Enable the **Group Combination**.

-  means enabled.
-  means not enabled.

3.6.3 Alarm Configuration

Administrators can manage visitors' unlock authority through alarm configuration. Select **Access > Alarm**. The Alarm interface is displayed. See Figure 3-10.

Figure 3-10 Alarm

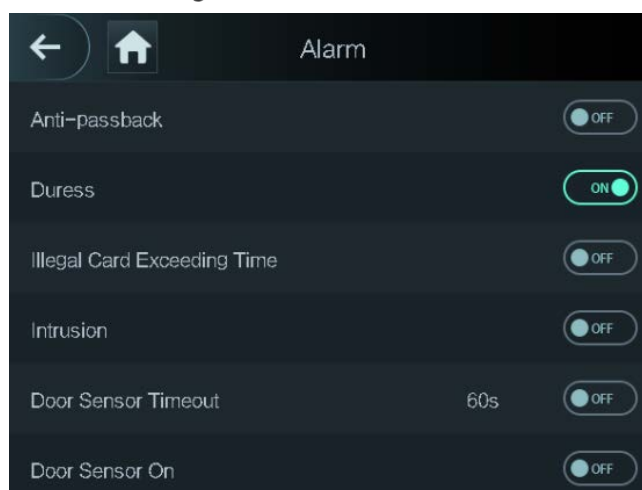

-  means enabled.

-  means not enabled.

Table 3-4 Parameters on the alarm interface

Parameter	Description
Anti-passback	<ul style="list-style-type: none"> • If a person unlocks the door with the identity checked by the access controller, but when the person gets out without getting the identity checked by the access controller, an alarm will be triggered and the person will have no authority to unlock the door any more. • If a person gets inside a building or a room without swiping the card, and the person swiped the card to get out, then the person will have no authority to unlock the door any more.
Duress	An alarm will be triggered when a duress card, duress password, or duress fingerprint is used to unlock the door.
Illegal Card Exceeding Time	After an unauthorized card is used to unlock the door more than 5 times in 50 seconds, an alarm will be triggered.
Intrusion	An intrusion alarm will be triggered if a door is unlocked without having the door contact released.
Door Sensor Timeout	A timeout alarm will be triggered if the time that a user takes to unlock the door exceeds the Door Sensor Timeout time. The Door Sensor Timeout time range is 1–9999 seconds.
Door Sensor On	Only when the Door Sensor On is enabled can the intrusion alarm and door sensor timeout alarm be triggered.

3.6.4 Door Status

There are three options: **NO**, **NC**, and **Normal**.

- **NO**: If **NO** is selected, the door status is normally open, which means the door will never be closed.
- **NC**: If **NC** is selected, the door status is normally closed, which means the door will not be unlocked.
- **Normal**: If **Normal** is selected, the door will be unlocked and locked depending on your settings.

3.6.5 Lock Holding Time

Lock Holding Time is the duration in which the lock is unlocked. If the lock has been unlocked for a period that exceeds the duration, the lock will be automatically locked.

3.7 Network Communication (Touch Screen Only)

To make the access controller work normally, you need to configure parameters for network, serial ports and Wiegand ports.

3.7.1 IP Address

3.7.1.1 IP Configuration

Configure an IP address for the access controller to make it be connected to the network. See Figure 3-11 and Table 3-5.

Figure 3-11 IP address configuration



Table 3-5 IP configuration parameters

Parameter	Description
IP Address/Subnet Mask/Gateway IP Address	The IP address, subnet mask, and gateway IP address should be on the same network segment. After configuration, tap  to save the configurations.
DHCP	DHCP (Dynamic Host Configuration Protocol). When the DHCP is enabled, the IP address can be automatically acquired, and the IP address, subnet mask and gateway IP address cannot be manually configured.
P2P	P2P is a private network traversal technology which enables user to manage devices without requiring DDNS, port mapping or transit server.

3.7.1.2 Active Register

By active registering, you can connect the access controller to the management platform, and then you can manage the access controller through the management platform.



Configurations you have made can be cleared on the managing platform, and the access controller can be initialized, you need to protect the platform managing authority in case of data loss caused by misoperation.

For active register parameter, see Table 3-6.

Table 3-6 Active register

Name	Parameter
Server IP Address	IP address of the managing platform.
Port	Port number of the managing platform.
Device ID	Subordinate device number on the managing platform.

3.7.1.3 Wi-Fi

You can connect the access controller to the network through Wi-Fi if the access controller has Wi-Fi function.

3.7.2 Serial Port Settings

Select serial input or serial output according to the entering direction and exiting direction.

Select **Connection > Serial Port**, and then the **Serial Port** interface is displayed. See Figure 3-12.

Figure 3-12 Serial port

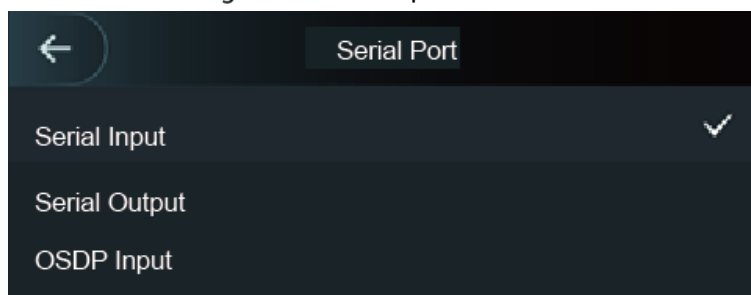

- Select **Serial Input** when external devices that are with card reading and writing functions are connected to the access controller. **Serial Input** is selected to enable access card information to be sent to the access controller and the management platform.
- For access controllers with face recognition, fingerprint recognition, card reading and writing functions, if you select **Serial Output**, access controller will send lock/unlock information to the access controller. There are two types of lock/unlock information:
 - ◇ User ID
 - ◇ Card No.
- Select **OSDP Input** when card reader of OSDP protocol is connected to the access controller. The access controller can send card information to the management platform.



This access controller cannot be connected to other devices as a card reader.

3.7.3 Wiegand Configuration

Select **Wiegand Input** or **Wiegand Output** according to the entering direction and exiting direction.

Select **Connection > Wiegand**, and then the **Wiegand** interface is displayed. See Figure 3-13.

Figure 3-13 Weigand

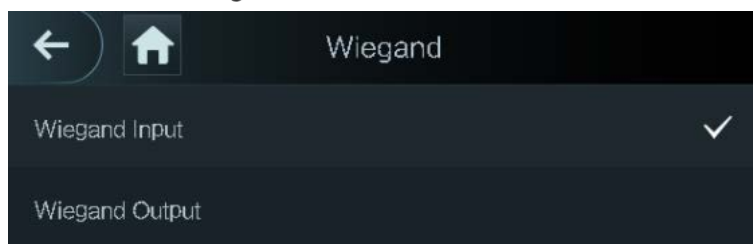

- Select **Weigand Input** when an external card swipe mechanism is connected to the access controller.
- Select **Weigand Output** when the access controller works as a reader that can be connected to the controller. See Table 3-7.

Table 3-7 Weigand output

Parameter	Description
Weigand output type	The Weigand Output Type determines the card number or the digit of the number than can be recognized by the access controller. <ul style="list-style-type: none"> • Weigand26, three bytes, six digits. • Weigand34, four bytes, eight digits. • Weigand66, eight bytes, sixteen digits.
Pulse Width	You can set pulse width and pulse interval.
Pulse Interval	
Output Data Type	You can select the types of output data. <ul style="list-style-type: none"> • User ID: If User ID is selected, and then user ID will be output. • Card No.: If Card No. is selected, and then card number will be output.



This access controller cannot be connected to other devices as a card reader.

3.8 System (Touch Screen Only)

3.8.1 Time

You can do date format setting, date setting, time setting, DST setting, NTP check, and time zone settings.



- When you select Network Time Protocol (NTP), you need to enable the NTP Check function first. Server IP Address: enter the IP address of the time server, time of the access controller will be synchronized with the time server.
- Port: Enter the port number of the time server.
- Interval (min): NPT check interval. Tap the save icon to save.

3.8.2 Face Parameter

Figure 3-14 Face parameter

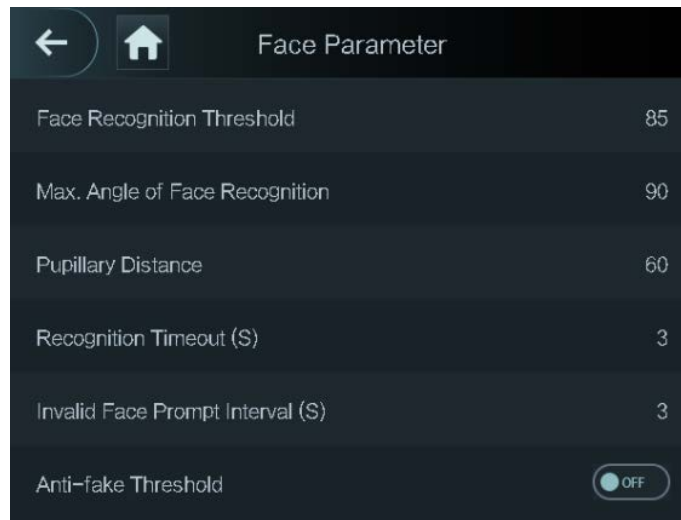

Tap a parameter and do configuration, and then tap .

Table 3-8 Face parameter

Name	Description
Face Recognition Threshold	Face recognition accuracy can be adjusted. The larger the value is, the higher the accuracy will be.
Max. Angle of Face Recognition	You can set the control panel shooting angle of profiles. The larger the value is, the wider range of the profiles will be recognized.
Pupillary Distance	Pupillary distance is the pixel value of the image between the centers of the pupils in each eye. You need to set an appropriate value so that the access controller can recognize faces as needed. The value changes according to the face sizes and the distance between faces and the lens. The closer the face is to the lens, the greater the value should be. If an adult is 1.5 meters away from the lens, the pupillary distance value can be within 50 to 70.
Recognition Timeout	When a person who does not have the access authority stands in front of the access controller and gets the face recognized, the controller will prompt that face recognition failed. The prompt interval is called recognition timeout.
Recognition Interval	When a person who has the access authority stands in front of the access controller and gets the face recognized, the controller will prompt that face recognition succeeded. The prompt interval is the recognition interval.
Anti-fake Threshold	This function prevents people from unlocking by human face images or face models. The larger the value is, the more difficult face images can unlock the door. The recommended value range is above 80.

3.8.3 Fill Light Mode Setting

You can select fill light modes according to your needs. There are three modes:

- Auto: When the photo sensor detects that the ambient environment is not dark, the fill light is normally off; otherwise, the fill light will be on.
- NO: The fill light is normally on.
- NC: The fill light is normally closed.

3.8.4 Fill Light Brightness Setting

You can select fill light brightness according to your needs.

3.8.5 Volume Adjustment

Tap  or  to adjust the volume.

3.8.6 IR Light Brightness Adjustment

The larger the value is, the clearer the images will be; otherwise the unclearer the images will be.

3.8.7 FP Parameter

Set the fingerprint accuracy level. The higher the level is, the lower the false recognition rate will be.

3.8.8 Restore to Factory Settings



- Data will be lost if you restore the access controller to the factory settings.
- After the access controller is restored to the factory settings, IP address will not be changed.

You can select whether to retained user information and logs.

- You can select to restore the access controller to the factory settings with all user information and device information deleted.
- You can select to restore the access controller to the factory settings with user information and device information retained.

3.8.9 Reboot

Select **Setting** > **Reboot**, tap **Reboot**, and the access controller will be rebooted.

3.9 USB (Touch Screen Only)



- Make sure that the USB is inserted before exporting user information and updating. During exporting or updating, do not pull out the USB or do other operations; otherwise the exporting or updating will fail.
- You need to import information from one access controller to the USB before using USB to import information to another access controller.

- USB can also be used to update the program.

3.9.1 USB Export

You can export data from the access controller to the USB after inserting the USB. The data exported is encrypted and cannot be edited.

Step 1 Select **USB > USB Export**.

The **USB Export** interface is displayed. See Figure 3-15.

Figure 3-15 USB export

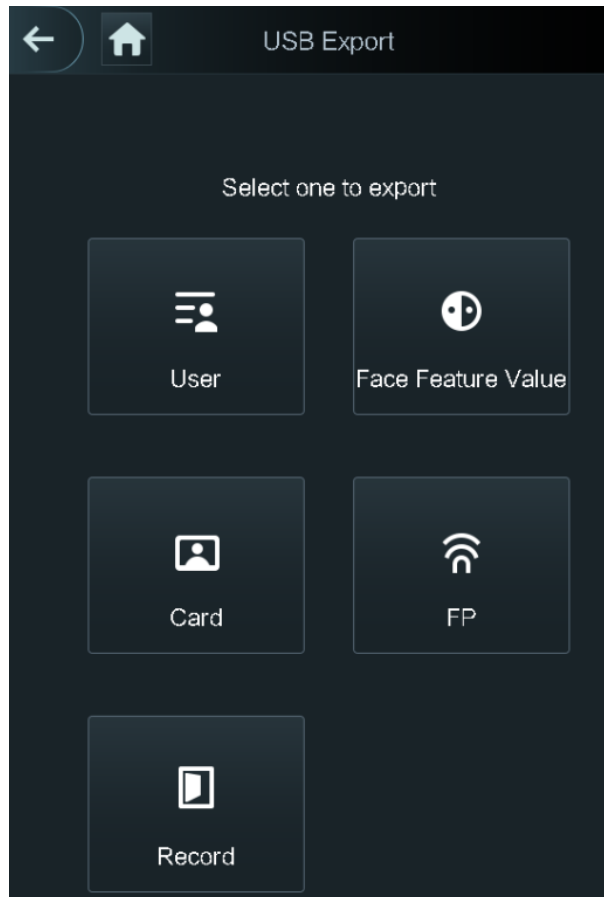

Step 2 Select the data type that you want to export.

The prompt Confirm to export is displayed.

Step 3 Tap **OK**.

Data exported will be saved in the USB.

3.9.2 USB Import

Only data in the USB that was exported from one access controller can be imported into another access controller.

Step 1 Select **USB > USB Import**.

The **USB Import** interface is displayed. See Figure 3-16.

Figure 3-16 USB Import

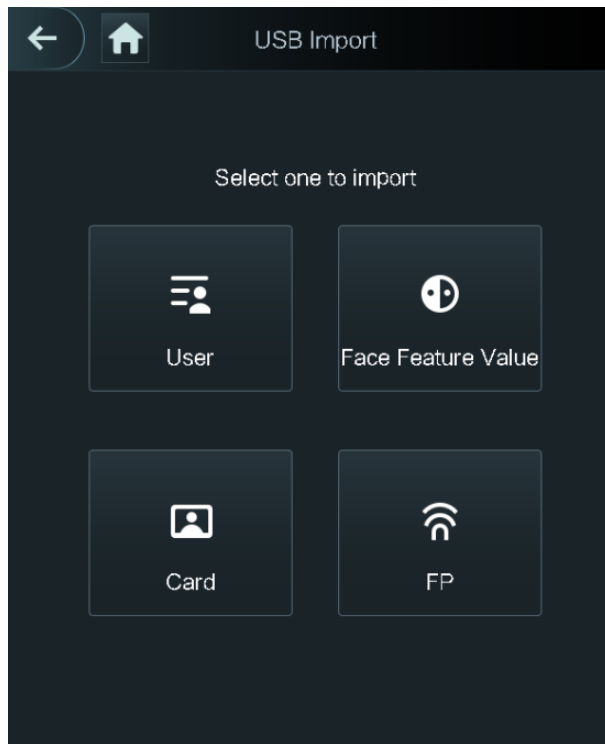

Step 2 Select the data type that you want to import.

The prompt **Confirm to import** is displayed.

Step 3 Tap **OK**.

Data in the USB will be imported into the access controller.

3.9.3 USB Update

USB can be used to update the system.

Step 1 Rename the updating file name to "update.bin", and save the "update.bin" file in the root directory of the USB.

Step 2 Select **USB > USB Update**.

The prompt **Confirm to Update** is displayed.

Step 3 Tap **OK**.

The update starts, and the access controller reboots after the update is finished.

3.9.4 Features

You can do settings about privacies, card number reverse, security module, door sensor type, and result feedback. For details of the functions mentioned, see Figure 3-17 and Table 3-9.

Figure 3-17 Features

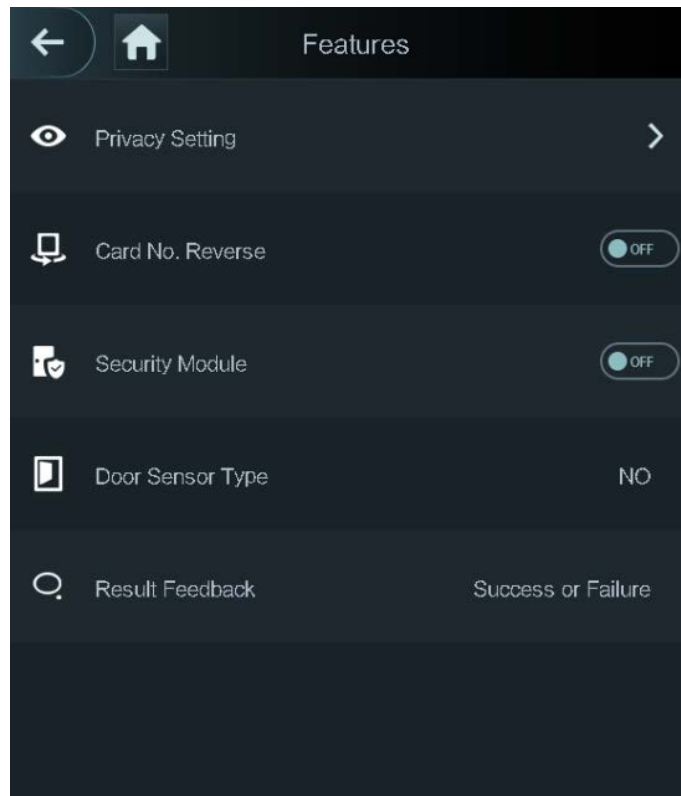

Table 3-9 Feature description

Parameter	Description
Privacy Setting	See "3.9.5 Privacy Setting" for details.
Card No. Reverse	If the third party card reader needs to be connected to the access controller through the wiegand output port, you need to enable the Card No. Reverse function; otherwise the communication between the access controller and the third party card reader might fail due to protocol discrepancy.
Security Module	<ul style="list-style-type: none"> ● If the security module is enabled, you need to purchase access control security module separately. The security module needs separate power supply to provide power. ● Once the security module is enabled, the exit button, lock control and firefighting linkage will be invalid.
Door Sensor Type	There are two options: NO and NC .
Result Feedback	Displays whether the unlock succeeded or failed.

3.9.5 Privacy Setting

Figure 3-18 Privacy setting

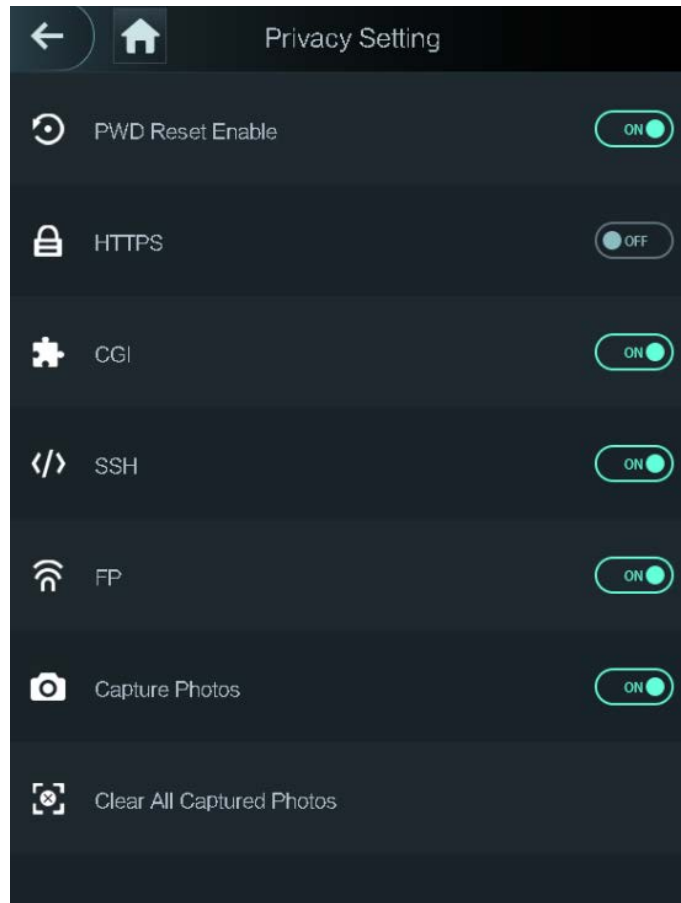



Table 3-10 Features

Parameter	Description
PWD Reset Enable	If the PWD Reset Enable function is enabled, you can reset the password. The PWD Reset function is enabled by default.
HTTPS	Hypertext Transfer Protocol Secure (HTTPS) is a protocol for secure communication over a computer network. When HTTPS is enabled, HTTPS will be used to access CGI commands; otherwise HTTP will be used.  When HTTPS is enabled, the access controller will restart automatically.
CGI	Common Gateway Interface (CGI) offers a standard protocol for web servers to execute programs that execute like console applications running on a server that generates web pages dynamically. When CGI is enabled, CGI commands can be used. The CGI is enabled by default.
SSH	Secure Shell (SSH) is a cryptographic network protocol for operating network services securely over an unsecured network. When SSH is enabled, SSH provides cryptographic service for the data transmission.

Parameter	Description
FP	If you select OFF for Fingerprint (FP), users' fingerprint information will not be displayed when they get fingerprints recorded or when they use fingerprints to unlock the door.
Capture photo	If you select ON, when a user unlocks the door, the user's photo will be automatically taken. This function is ON by default.
Clear all captured photos	Tap the icon, and you can delete all captured photos.

3.9.6 Result Feedback

You can select a result feedback mode as needed.

Mode 1

Figure 3-19 Mode 1

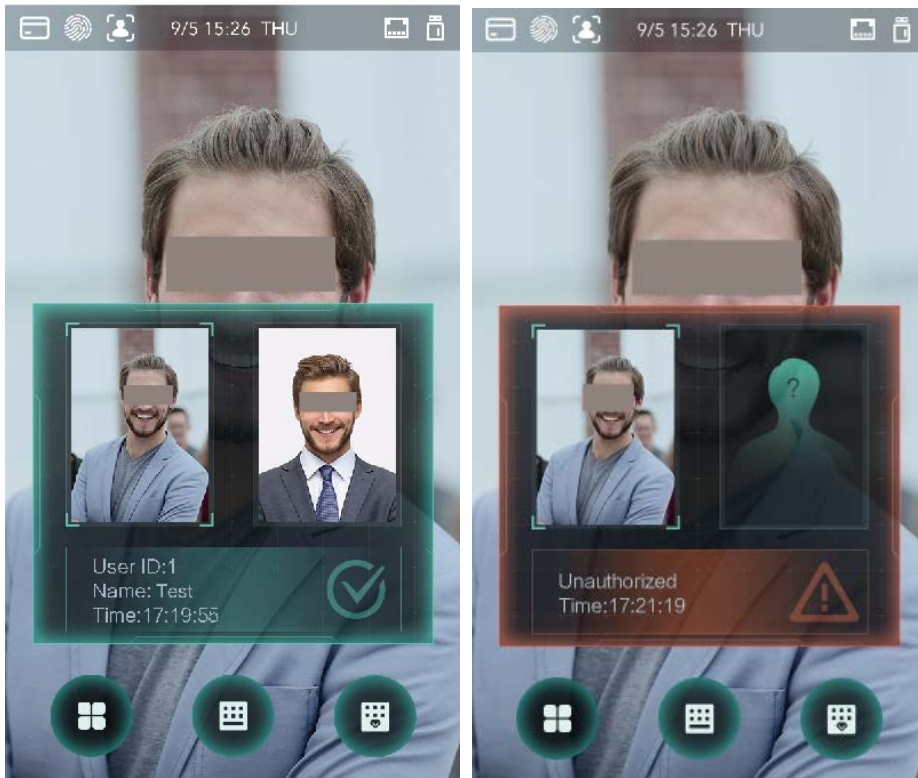

Mode 2

Figure 3-20 Mode 2

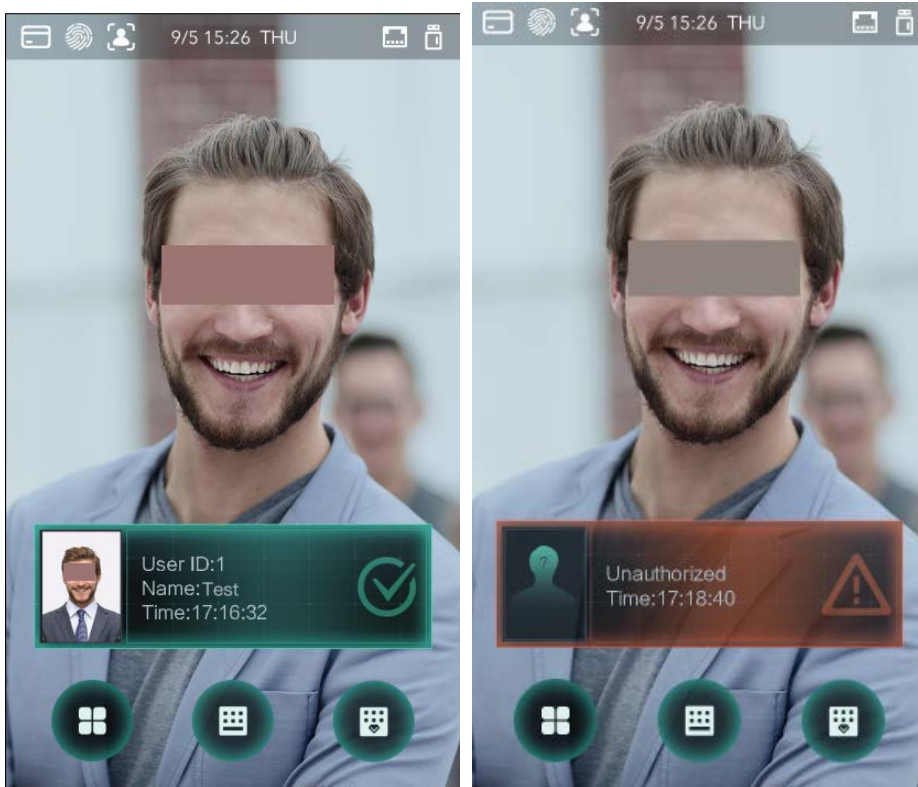

Mode 3

Figure 3-21 Mode 3



Mode 4

Figure 3-22 Mode 4

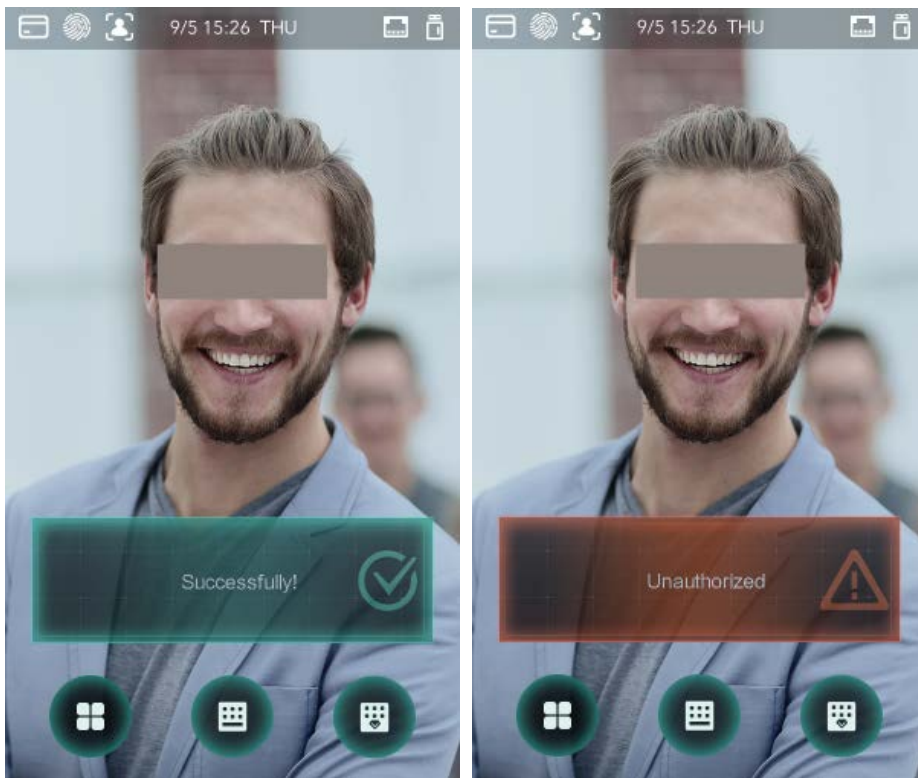

3.10 Record (Touch Screen Only)

You can query all unlocking records.

Figure 3-23 Search punch records

User ID.	Name	Time	Status	Verify Mode
		09-05 17:21	Failed	Face
1	zxl	09-05 17:19	OK	Face
1	zxl	09-05 17:19	OK	Face
1	zxl	09-05 17:19	OK	Face
1	zxl	09-05 17:19	OK	Face
		09-05 17:18	Failed	Face
		09-05 17:18	Failed	Face
		09-05 17:18	Failed	Face
		09-05 17:18	Failed	Face
		09-05 17:18	Failed	Face
		09-05 17:18	Failed	Face

3.11 Auto Test (Touch Screen Only)

When you use the access controller for the first time or when the access controller malfunctioned, you can use auto test function to check whether the access controller can work normally. Do actions according to the prompts.

Figure 3-24 Auto test

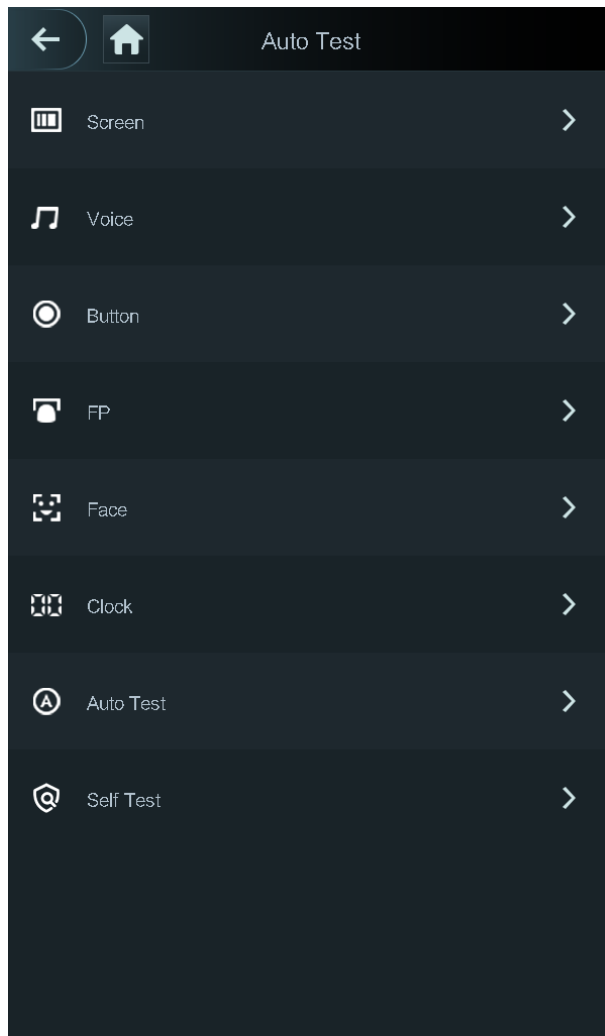

When you select **Auto Test**, the access controller will guide you to do all the auto tests.

3.12 System Info (Touch Screen Only)

You can view data capacity, device version, and firmware information of the access controller on the **System Info** interface.

4 Web Operation

The access controller can be configured and operated on the web. Through the web you can set network parameters, video parameters, and access controller parameters; and you can also maintain and update the system.

4.1 Initialization

You need to set a password and an email address before logging in to the web for the first time.

Step 1 Open IE web browser, and enter the IP address (the default address is 192.168.1.108) of the access controller in the address bar, and then press Enter.

The **Initialization** interface is displayed. See Figure 4-1.



Use browser newer than IE 8, otherwise you might not log in to the web.

Figure 4-1 Initialization

Boot Wizard

① Device Initialization ② Auto Check

Username admin

New Password

Low Medium High

Confirm Password

Password shall be at least 8 digits, and shall at least include two types, including number, letter and common character

Bind Email

(It will be used to reset password. Please fill in or complete it timely)

Next

Step 2 Enter the new password, confirm password, enter an email address, and then tap **Next**.



- For security, keep the password properly after initialization and change the password regularly.
- The password should consist of 8 to 32 non-blank characters and contain at least two types of characters among upper case, lower case, number, and special character (excluding ' " ; : &). Set a password of high security level according to the password strength prompt.
- When you need to reset the administrator password by scanning the QR code, you need an email address to receive the security code.

Step 3 Click **Next**.

The **Auto Check** interface is displayed. See Figure 4-2.

Figure 4-2 Auto Test

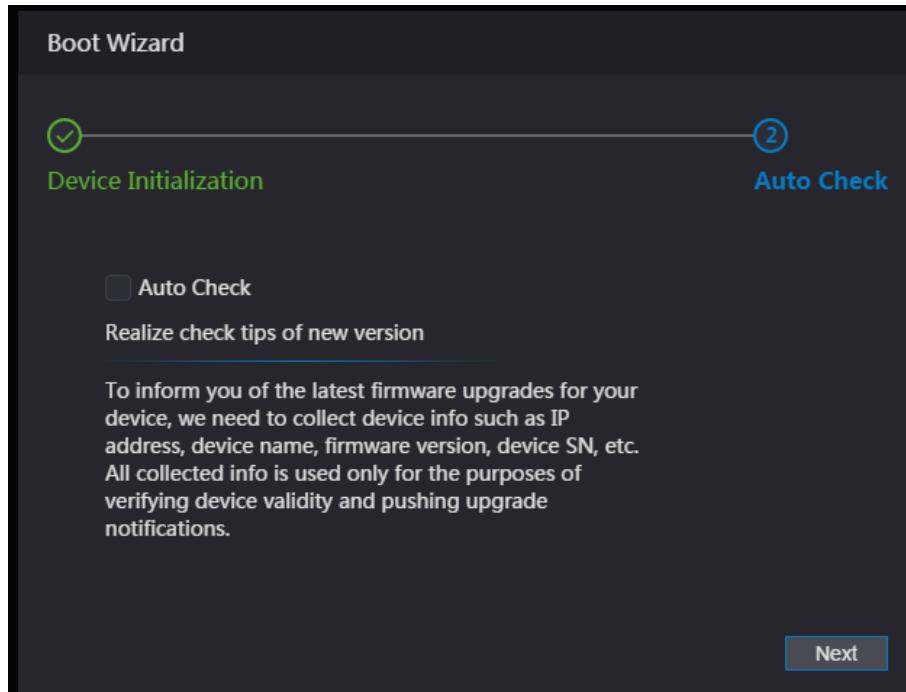

Step 4 You can decide whether to select **Auto Check** or not.



It is recommended that **Auto Check** be selected to get the latest program in time.

Step 5 Click Next.

The configuration is finished. See Figure 4-3.

Figure 4-3 Finished configuration

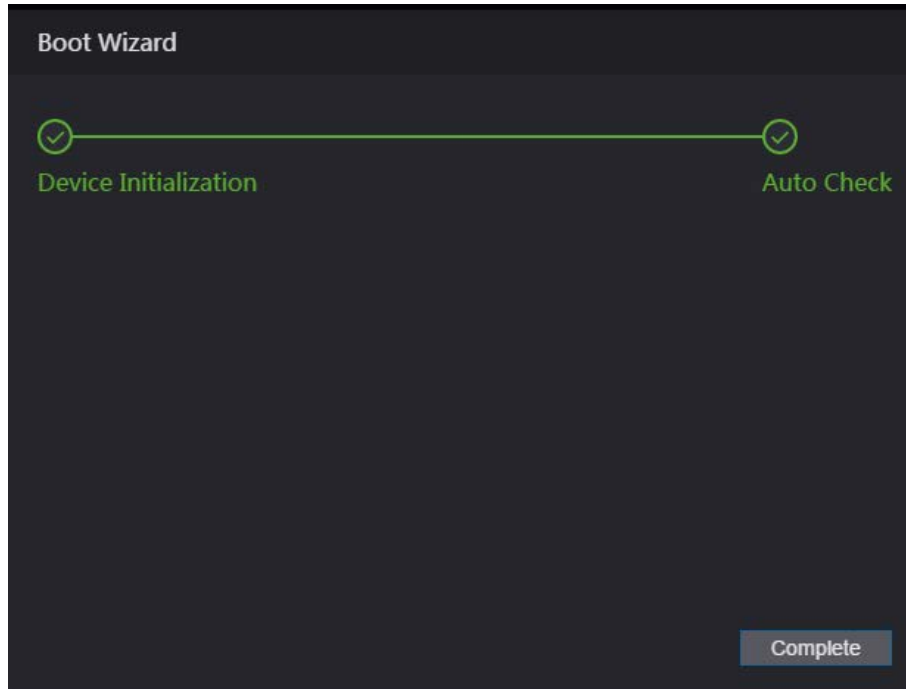

Step 6 Click **Complete**, and the initialization is completed.
The web login interface is displayed.

4.2 Login

Step 1 Open IE web browser, enter the IP address of the access controller in the address bar, and

press **Enter**.

Figure 4-4 Login

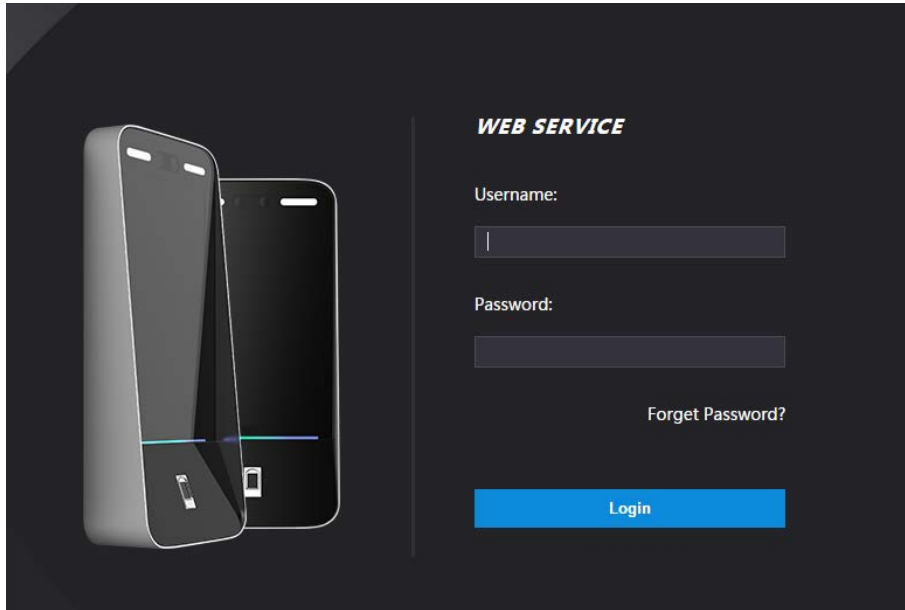

Step 2 Enter the user name and password.



- The default administrator name is admin, and the password is the login password after initializing the access controller. Modify the administrator regularly and keep it properly for the sake of security.
- If you forget the administrator login password, you can click **Forgot password?** to reset it. See "4.3 Reset the Password."

Step 3 Click **Login**.

The web interface is logged in.

4.3 Reset the Password

When resetting the password of the admin account, your email address will be needed.

Step 1 Click **Forgot password?** on the login interface.

The **Tips** interface is displayed.

Figure 4-5 Tips

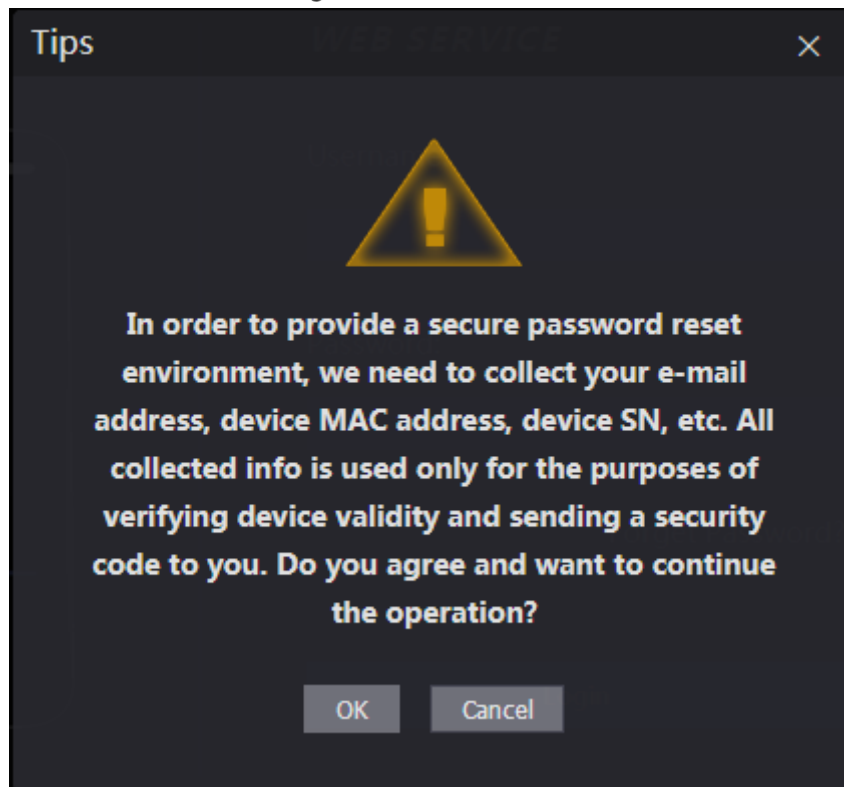

Step 2 Read the tips.

Step 3 Click OK.

The **Reset Password** interface is displayed.

Figure 4-6 Reset Password

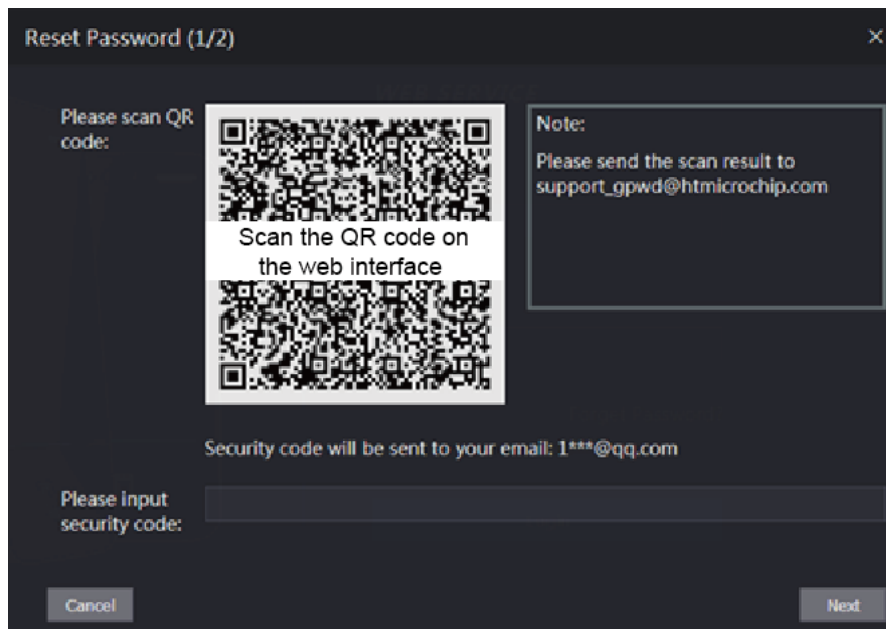

Step 4 Scan the QR code on the interface, and you will get the security code.



- At most two security codes will be generated by scanning the same QR code. If security codes become invalid, to get more security codes, refresh the QR code.
- You need to send the content you get after you scanned the QR code to the designated email address, and then you will get the security code.

- Please use the security code within 24 hours after you receive it. Otherwise, it will become invalid.
- If wrong security codes are entered for consecutive five times, the administrator will be frozen for five minutes.

Step 5 Enter the security code you have received.

Step 6 Click **Next**.

The **Reset Password** interface is displayed.

Step 7 Reset and confirm the new password.



The password should consist of 8 to 32 non-blank characters and contain at least two types of characters among upper case, lower case, number, and special character (excluding ' " ; : &).

Step 8 Click **OK**, and the reset is completed.

4.4 Alarm Linkage

4.4.1 Setting Alarm Linkage

Alarm input devices can be connected to the access controller, and you can modify the alarm linkage parameter as needed.

Step 1 Select **Alarm Linkage** on the navigation bar.

The **Alarm Linkage** interface is displayed. See Figure 4-7.

Figure 4-7 Alarm linkage

Alarm Input	Name	Alarm Input Type	Alarm Output Channel	Modify
1	Zone1	NO	1	
2	Zone2	NO	1	

Step 2 Click , and then you can modify alarm linkage parameters. See Figure 4-8

Figure 4-8 Modifying alarm linkage parameter

The screenshot shows a 'Modify' dialog box with the following parameters:

- Alarm Input: 1
- Name: Zone1
- Alarm Input Type: NO
- Fire Link Enable:
- Alarm Output Enable:
- Duration (Sec.): 30 (range 1~300)
- Alarm Output Channel: 1, 2
- Access Link Enable:
- Channel Type: NO

Buttons: OK, Cancel

Table 4-1 Alarm linkage parameter description

Parameter	Description
Alarm Input	You cannot modify the value. Keep it default.
Name	Enter a zone name.
Alarm Input Type	There are two options: NO and NC. If alarm input type of the alarm device you purchased is NO, then you should select NO; otherwise you should select NC.
Fire Link Enable	If fire link is enabled the access controller will output alarms when fire alarms are triggered. The alarm details will be displayed in the alarm log.  Alarm output and access link are NO by default if fire link is enabled.
Alarm Output Enable	The relay can output alarm information (will be sent to the management platform) if the Alarm Output is enabled.
Duration (Sec.)	The alarm duration, and the range is 1–300 seconds.
Alarm Output Channel	You can select an alarm output channel according to the alarming device that you have installed. Each alarm device can be regarded as a channel.
Access Link Enable	After the Access Link is enabled, the access controller will be normally on or normally closed when there are input alarm signals.
Channel Type	There are two options: NO and NC.

Step 3 Click **OK**, and then the configuration is completed.



The configuration on the web will be synchronized with the configuration in the client if the access controller is added to a client.

4.4.2 Alarm Log

You can view the alarm type and time range in the **Alarm Log** interface.

Step 1 Select **Alarm Linkage > Alarm Log**.

The **Alarm Log** interface is displayed. See Figure 4-9.

Figure 4-9 Alarm log

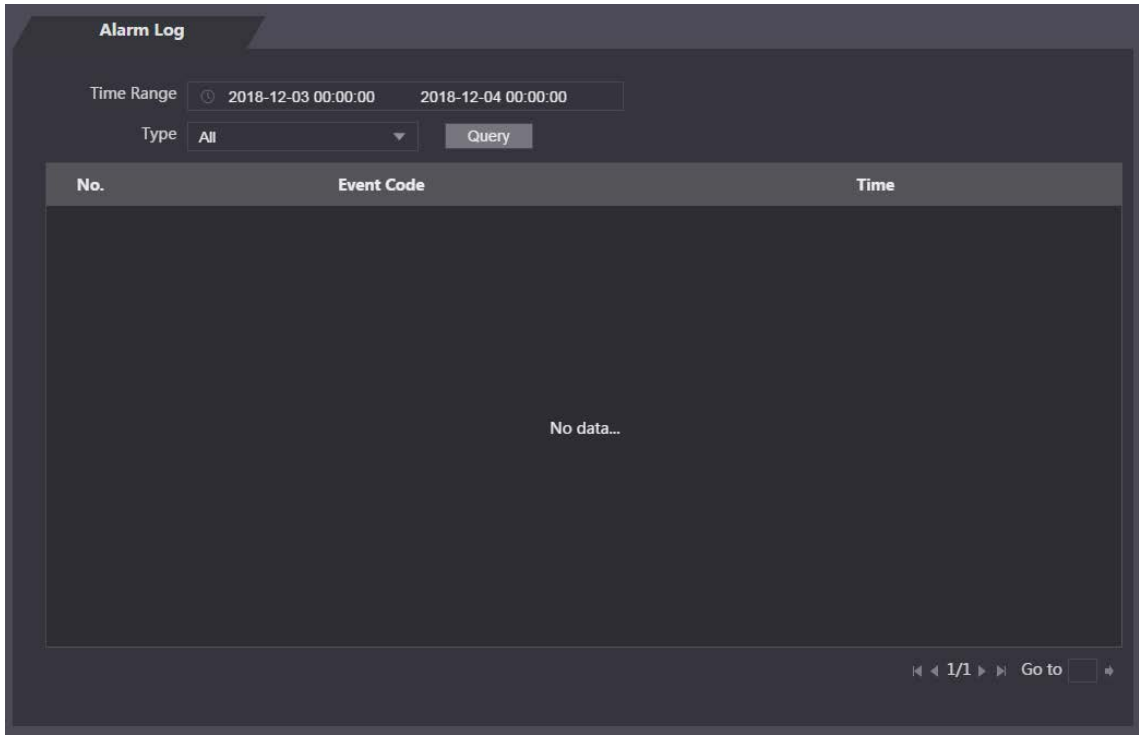

Step 2 Select a time range and alarm type, and then click **Query**.

The query results are displayed. See Figure 4-10.

Figure 4-10 Query results

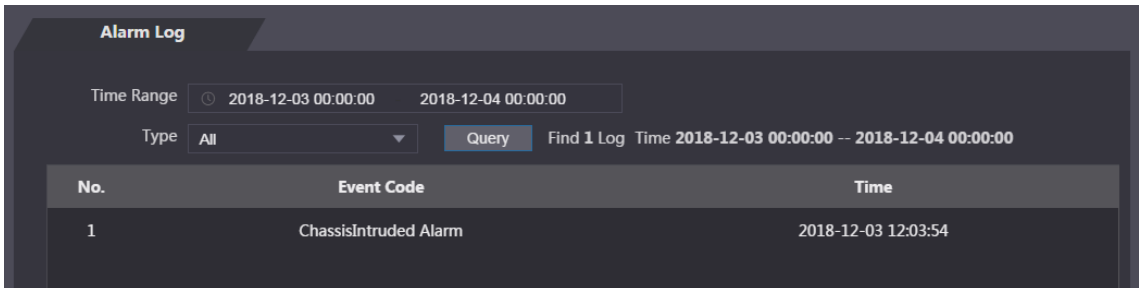

4.5 Data Capacity

You can see how many users, cards, face images, and fingerprints the access controller can hold on the **Data Capacity** interface.

Figure 4-11 Data capacity

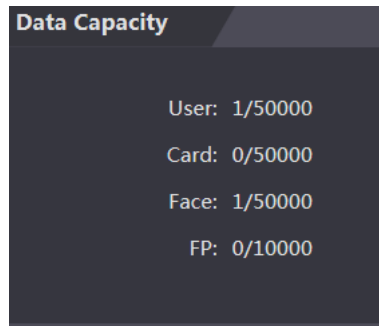

4.6 Video Setting

You can set parameters including data rate, image parameters (brightness, contrast, hue, saturation, and more), and exposure on the **Video Setting** interface.

4.6.1 Data Rate

Figure 4-12 Data rate

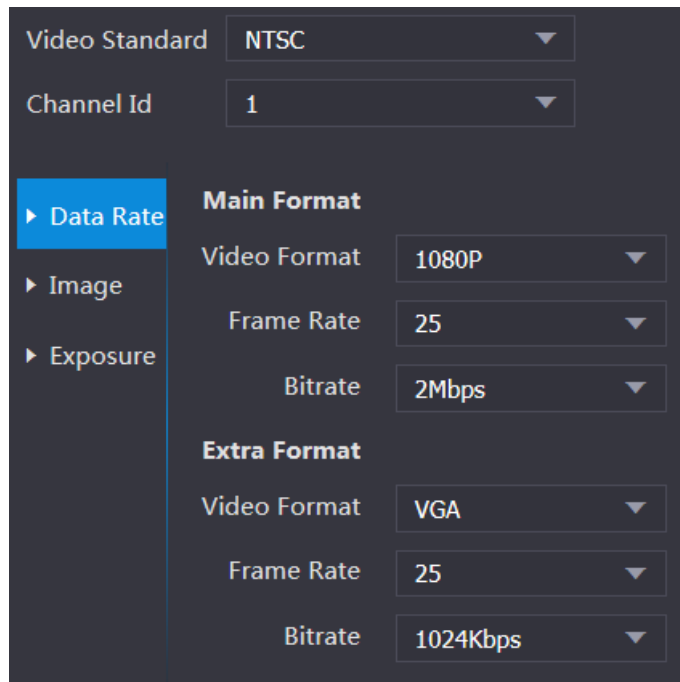

Table 4-2 Data rate parameter description

Parameter		Description
Video Standard		There are two options: NTSC and PAL. Select a standard according to the video standard of your region.
Channel		There are two options: 1 and 2. 1 is white light camera and 2 is IR light camera.
Main Format	Video Format	There are four options: D1, VGA, 720p and 1080p. Select an option according to the video quality you want.
	Frame Rate	The rate at which consecutive frames appear on a display. The frame rate range is 1–25fps.

Parameter		Description
	Bit Rate	The number of bits that are conveyed or processed per unit of time. There are five options: 1.75Mbps, 2Mbps, 4Mbps, 6Mbps, and 8Mbps.
Extra Format	Video Format	There are three options: D1, VGA, and QVGA.
	Frame Rate	The rate at which consecutive frames appear on a display. The frame rate range is 1–25fps.
	Bit Rate	The number of bits that are conveyed or processed per unit of time. There are options: 256Kbps, 320Kbps, 384Kbps, 448Kbps, 512Kbps, 640Kbps, 768Kbps, 896Kbps, 1024Kbps, 1.25Mbps, 1.5Mbps, and 1.75Mbps.

4.6.2 Image

There are two channels, and you need to configure parameters for each channel.

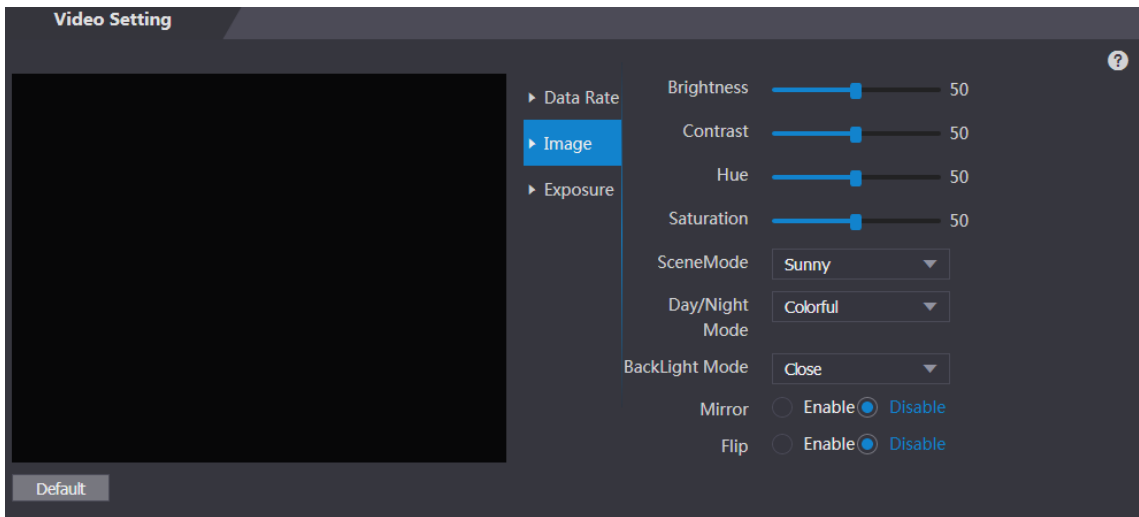

Step 1 Select **Video Setting > Video Setting > Image**.

Figure 4-13 Image



Step 2 Select Wide Dynamic in the Backlight Mode.

Table 4-3 Image parameter description

Parameter	Description
Brightness	The larger the value is, the brighter the images will be.
Contrast	Contrast is the difference in luminance or color that makes an object distinguishable. The larger the contrast value is, the greater the brightness and color contrast will be.
Hue	The larger the value is, the deeper the color will be.
Saturation	The larger the value is, the brighter the colors will be.  The value does not change image brightness.
Scene Mode	<ul style="list-style-type: none"> ● Close: Without modes. ● Auto: The system automatically adjusts scene modes. ● Sunny: In this mode, image hue will be reduced. ● Night: In this mode, image hue will be increased.  Sunny is selected by default.

Parameter	Description
Day/Night Mode	<p>Day/Night mode decides the working status of the fill light.</p> <ul style="list-style-type: none"> ● Auto: The system automatically adjusts the day/night modes. ● Colorful: In this mode, images are with colors. ● Black and white: In this mode. Images are in black and white.
Back Light Mode	<ul style="list-style-type: none"> ● Close: Without back light. ● BLC: Backlight compensation corrects regions with extremely high or low levels of light to maintain a normal and usable level of light for the object in focus. ● WDR: In the wide dynamic range mode, the system dims bright areas and compensates dark areas to ensure the definition of objects in the bright areas and dark areas.  <p>When human faces are in the backlight, you need to enable the Wide Dynamic.</p> <ul style="list-style-type: none"> ● HLC: Highlight compensation is needed to compensate for overexposure of highlights or strong light sources like spotlights, headlights, porch lights, etc. to create an image that is usable and not overtaken by a bright light.
Mirror	When the function is enabled, images will be displayed with left and right side reversed.
Flip	When this function is enabled, videos can be flipped over.

4.6.3 Exposure

For exposure parameter descriptions, see Table 4-4.

Table 4-4 Exposure parameter description

Parameter	Description
Anti-flicker	<ul style="list-style-type: none"> ● 50Hz: When the utility frequency of alternating current is 50Hz, the exposure is automatically adjusted to make sure that there are no stripes on images. ● 60Hz: When the utility frequency of alternating current is 60Hz, the exposure is automatically adjusted to make sure that there are no stripes on images. ● Outdoor: When Outdoor is selected, the exposure mode can be switched.

Parameter	Description
Exposure Mode	 <ul style="list-style-type: none"> When you select Outdoor in the Anti-flicker drop-down list, you can select Shutter Priority as the exposure mode. Exposure modes of different devices might vary, and the actual product shall prevail. <p>You can select from:</p> <ul style="list-style-type: none"> Auto: The access controller will automatically adjust brightness of images. Shutter Priority: The access controller will adjust image brightness according to shutter exposure value range. If the image brightness is not enough and the shutter value has reached upper or lower limit, the access controller will adjust gain value automatically to get ideal brightness. Manual: You can configure gain and shutter value manually to adjust image brightness.
Shutter	The larger the shutter value is and the shorter the exposure time is, the darker the images will be.
Shutter Value Range	If you select Customized Range , you can customize the shutter value range.
Gain Value Range	When the gain value range is set, video quality will be improved.
Exposure Compensation	You can increase video brightness by adjusting exposure compensation value.
3D NR	When 3D Noise Reduction (RD) is enabled, video noise can be reduced, and high definition videos will be produced.
Grade	You can adjust the value of the 3D NR when 3D NR is enabled. The larger the value is, the less the noise there will be.

4.6.4 Motion Detection

Set a range in which moving objects can be detected.

Step 1 Select **Video Setting > Video Setting > Motion Detection**.

The **Motion Detection** interface is displayed. See Figure 4-14.

Figure 4-14 Motion detection

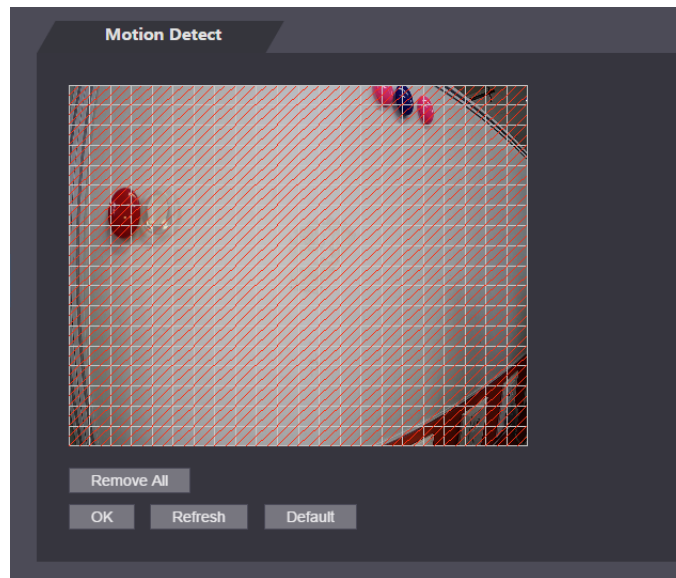

Step 2 Press and hold the left mouse button, and then drag the mouse in the red area. The Motion Detection area is displayed. See Figure 4-15.



- The red rectangles are motion detection area. The default motion detection range is all the rectangles.
- To draw a motion detection area, you need to click **Remove All** first.
- The motion detection area you draw will be a non-motion detection area if you draw in the default motion detection area.

Figure 4-15 Motion detection area

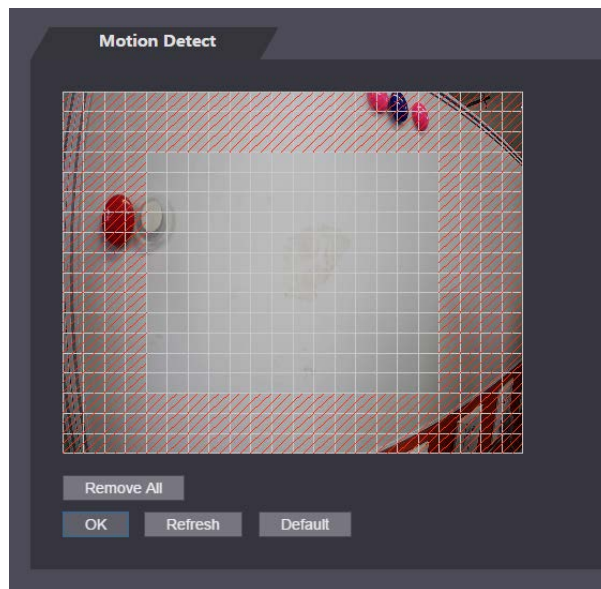

Step 3 Click **OK** to finish the setting.

4.6.5 Volume Setting

You can adjust volume of the access controller speaker.

Figure 4-16 Volume setting

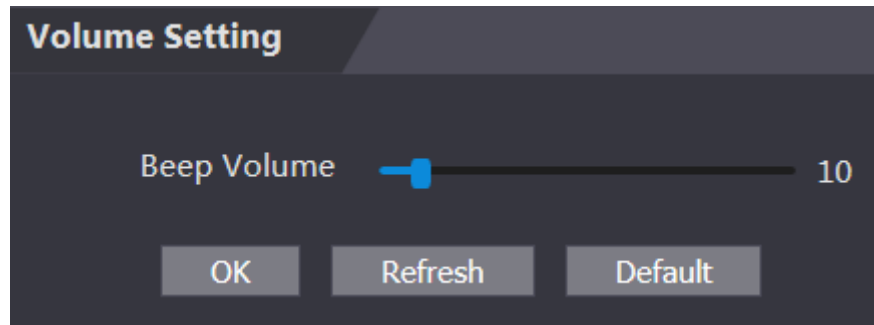

4.6.6 Image Mode

There are three options: indoor, outdoor and other. Select **Indoor** when the access controller is installed indoors; select **Outdoor** when the access controller is installed outdoors; and select **Other** when the access controller is installed at places with backlights like corridors and hallways.

Figure 4-17 Image mode

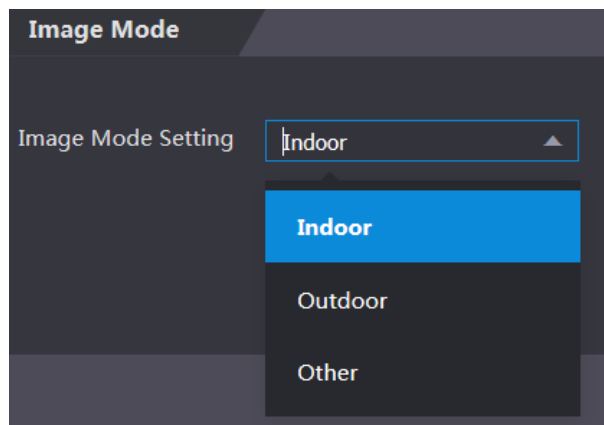

4.7 Face Detect

You can configure human face related parameters on this interface to increase the accuracy of the face recognition.

Step 1 Select **Face Detect**.

The **Face Detect** interface is displayed. See Figure 4-18.

Figure 4-18 Face detect

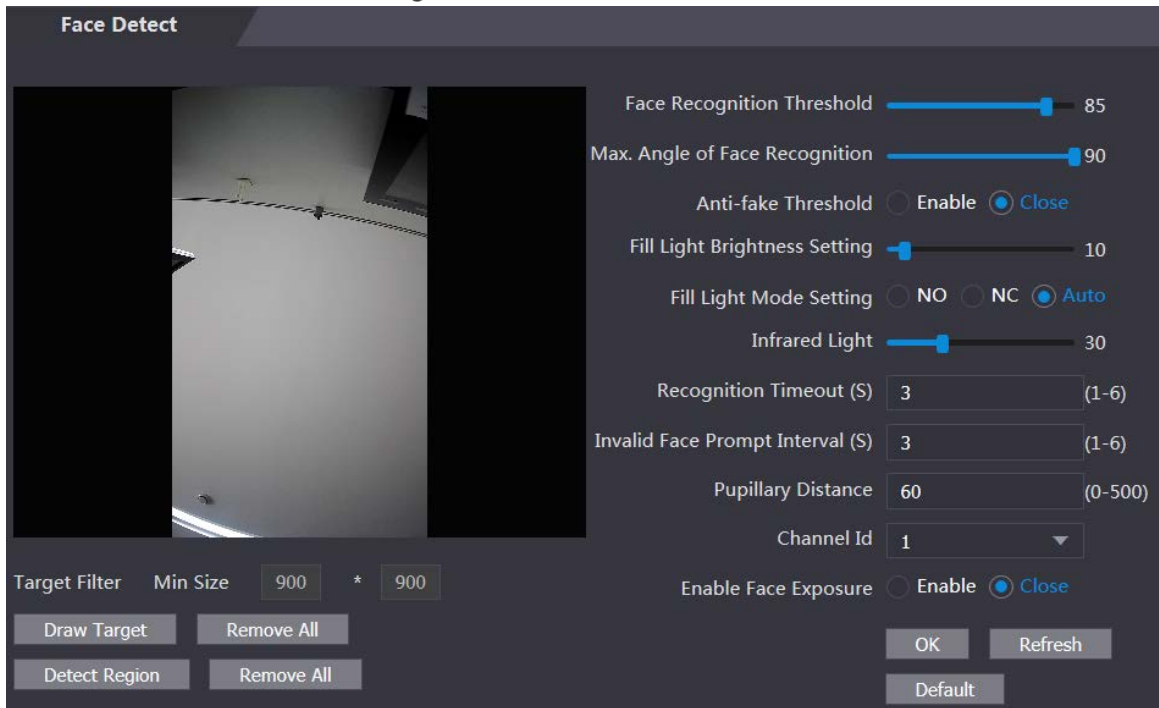

Step 2 Configure parameters. See Table 4-5.

Table 4-5 Face detect parameter description

Parameter	Description
Face Recognition Threshold	The larger the value is, the higher the accuracy will be.
Max. Angle of Face Recognition	The larger the angle is, the wider range of the profiles will be recognized.
Anti-fake Threshold	There are two options: Enable and Close .
Fill Light Brightness Setting	You can set fill light brightness.
Fill Light Mode Setting	There are three fill light modes. <ul style="list-style-type: none"> ● NO: Fill light is normally on. ● NC: Fill light is normally closed. ● Auto: Fill light will be automatically on when a motion detection event is triggered.  <p>When Auto is selected, the fill light will not be on even if Infrared Light value is greater than 19.</p>
Infrared Light	Adjust IR brightness by dragging the scroll bar.
Recognition Timeout	When a person who does not have the access authority stands in front of the access controller and gets the face recognized, the controller will prompt that face recognition failed. The prompt interval is called recognition timeout.
Invalid Face Prompt Interval	When a face has no access authority stands in front of the access controller, the controller will prompt that the face is invalid. The prompt interval is invalid face prompt interval.
Pupillary Distance	Pupillary distance is the pixel value of the image between the centers of the pupils in each eye. You need to set an appropriate value so that the

Parameter	Description
	access controller can recognize faces as needed. The value changes according to the face sizes and the distance between faces and the lens. The closer the face is to the lens, the greater the value should be. If an adult is 1.5 meters away from the lens, the pupillary distance value can be within 50 to 70.
Enable Face Exposure	After face exposure is enabled, human face will be clearer when the access controller is installed outdoors.
Channel Id	There are two options: 1 and 2. 1 is white light camera and 2 is IR light camera.
Draw Target	Click Draw Target , and then you can draw the minimum face detection frame. Click Remove All , and you can remove all the frames you drew.
Detect Region	Click Detect Region , move your mouse, and you can adjust the face detection region. Click Remove All , and you can remove all the detection regions.

Step 3 Click **OK** to finish the setting.

4.8 Network Setting

4.8.1 TCP/IP

You need to configure IP address and DNS server to make sure that the access controller can communicate with other devices.

Precondition

Make sure that the access controller is connected to the network correctly.

Step 1 Select **Network Setting > TCP/IP**.

Figure 4-19 TCP/IP

Step 2 Configure parameters.

Table 4-6 TCP/IP

Parameter	Description
IP Version	There is one option: IPv4.
MAC Address	MAC address of the access controller is displayed.
Mode	<ul style="list-style-type: none"> ● Static Set IP address, subnet mask, and gateway address manually. ● DHCP <ul style="list-style-type: none"> ◇ After DHCP is enabled, IP address, subnet mask, and gateway address cannot be configured. ◇ If DHCP is effective, IP address, subnet mask, and gateway address will be displayed automatically; if DHCP is not effective, IP address, subnet mask, and gateway address will all be zero. ◇ If you want to see the default IP when DHCP is effective, you need to disable DHCP.
Link-local address	Link-local address is only available when IPv6 is selected in the IP version. Unique link-local addresses will be assigned to network interface controller in each local area network to enable communications. The link-local address cannot be modified.
IP Address	Enter IP address, and then configure subnet mask and gateway address.
Subnet Mask	
Default Gateway	IP address and gateway address must be in the same network segment.
Preferred DNS Server	Set IP address of the preferred DNS server.
Alternate DNS Server	Set IP address of the alternate DNS server.

Step 3 Click **OK** to complete the setting.

4.8.2 Port

Set the maximum connections clients that the access controller can be connected to and port numbers.

Step 1 Select **Network Setting > Port**.

The **Port** interface is displayed.

Step 2 Configure port numbers. See the following table.



Except max connection, you need to reboot the access controller to make the configuration effective after modifying values.

Table 4-7 Port description

Parameter	Description
Max connection	You can set the maximum connections of clients that the access controller can be connected to.  Platform clients like Smartpss are not counted.
TCP Port	Default value is 37777.
HTTP Port	Default value is 80. If other value is used as port number, you need to add this value behind the address when logging in through browsers.
HTTPS Port	Default value is 443.
RTSP Port	Default value is 554.

Step 3 Click **OK** to complete the setting.

4.8.3 Register

When connected to external network, the access controller will report its address to the server that is designated by the user so that clients can get access to the access controller.

Step 1 Select **Network Setting > Auto Register**.

The **Auto Register** interface is displayed.

Step 2 Select **Enable**, and enter host IP, port, and sub device ID.

Table 4-8 Auto register description

Parameter	Description
Host IP	Server IP address or server domain name.
Port	Server port used for auto registration.
Sub Device ID	Access controller ID assigned by the server.

Step 3 Click **OK** to complete the setting.

4.8.4 P2P

Peer-to-peer computing or networking is a distributed application architecture that partitions tasks or workloads between peers. Users can download mobile application by scanning QR code, and then register an account so that more than one access controller can be managed on the mobile app. You do not need to apply dynamic domain name, do port mapping or do not need transit server.



If you are to use P2P, you must connect the access controller to external network; otherwise the access controller cannot be used.

Figure 4-20 P2P

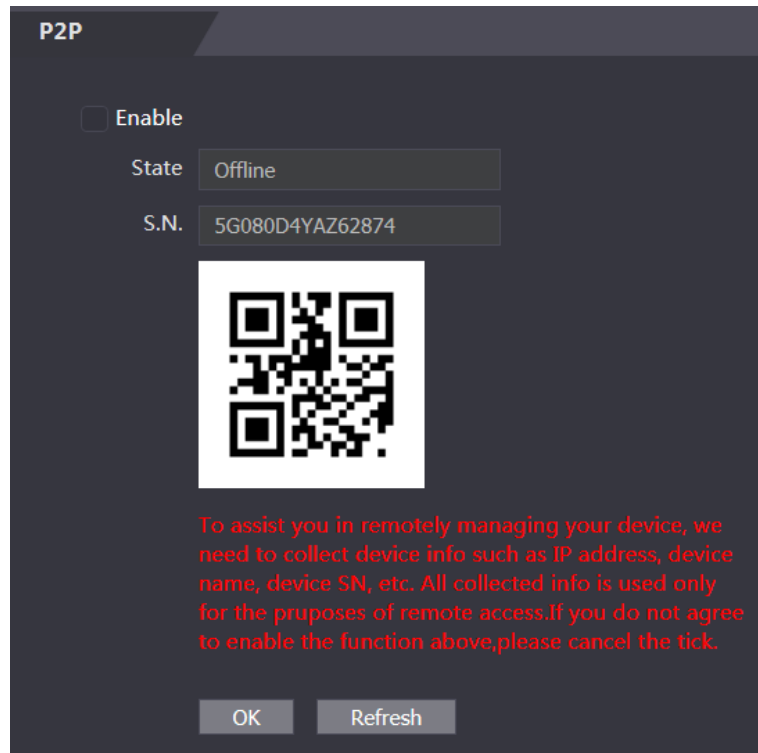

Step 1 Select **Network Setting > P2P**.

The **P2P** interface is displayed.

Step 2 Select **Enable** to enable P2P function.

Step 3 Click **OK** to complete the setting.



Scan the QR code on your web interface to get the serial number of the access controller.

4.9 Safety Management

4.9.1 IP Authority

Figure 4-21 IP authority

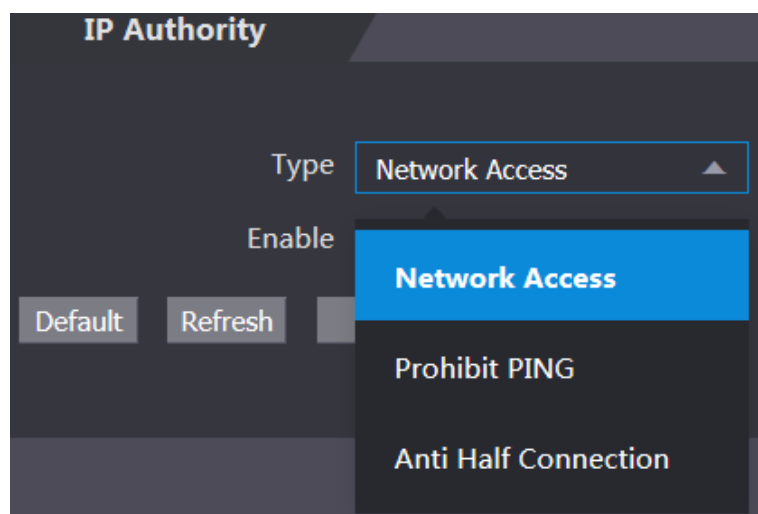

Select a cyber security mode as needed.

4.9.2 Systems

4.9.2.1 System Service

There are four options: SSH, PWD Reset Enable, CGI, and HTTPS. Refer to "3.9.4 Features" to select one or more than one of them.



The system service configuration done on the web page and the configuration on the **Features** interface of the access controller will be synchronized.

Figure 4-22 System service

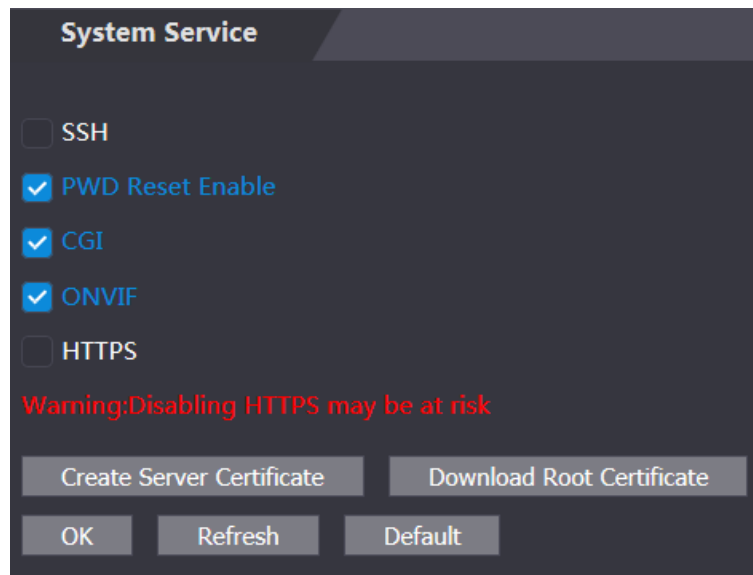

4.9.2.2 Create Server Certificate

Click **Create Server Certificate**, enter needed information, click **Save**, and then the access controller will reboot.

4.9.2.3 Download Root Certificate

Step 1 Click **Download Root Certificate**.

Select a path to save the certificate on the **Save File** dialog box.

Step 2 Double-click on the **Root Certificate** that you have downloaded to install the certificate.

Install the certificate by following the onscreen instructions.

4.9.3 User Management

You can add and delete users, modify users' passwords, and enter an email address for resetting the password when you forget your password.

4.9.3.1 Add Users

Click **Add** on the **User Mgmt.** interface to add users, and then enter username, password, confirmed password, and remark. Click **OK** to complete the user adding.

4.9.3.2 Modify User Information

You can modify user information by clicking  on the **User Mgmt.** interface. See Figure 4-23.

Figure 4-23 User management

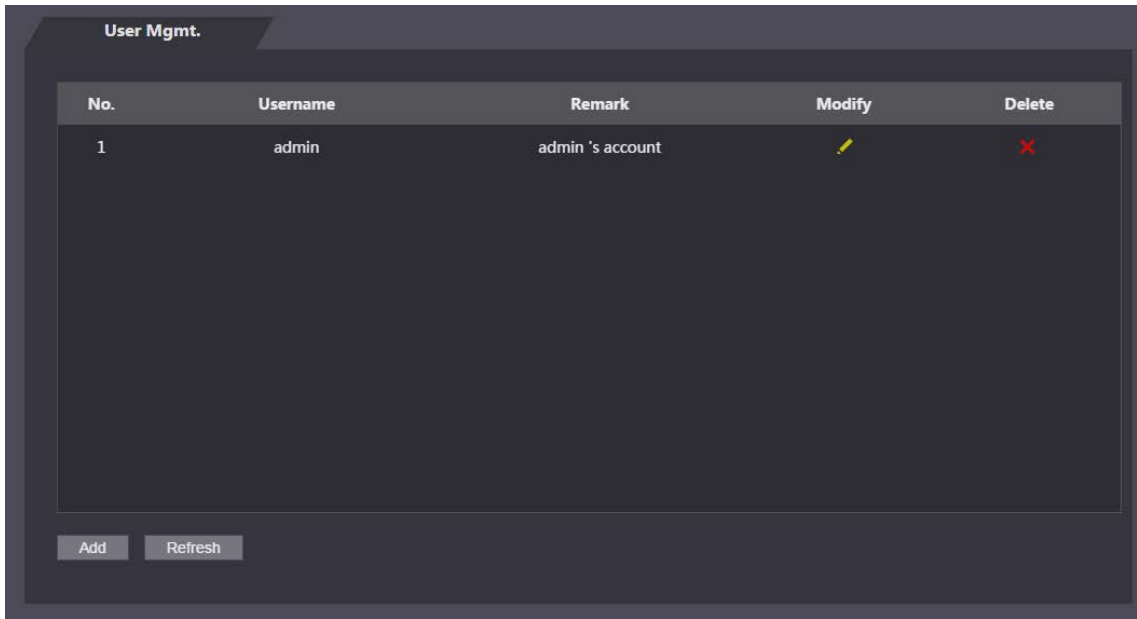

4.9.4 Maintenance

You can make the access controller reboot itself in idle time to improve the running speed of the access controller. You need to set the auto reboot date and time.

The default reboot time is at 2 O'clock in the morning on Tuesday. Click **Reboot Device**, the access controller will reboot immediately. Click **OK**, the access controller will reboot at 2 O'clock in the morning every Tuesday. See Figure 4-24.

Figure 4-24 Maintenance

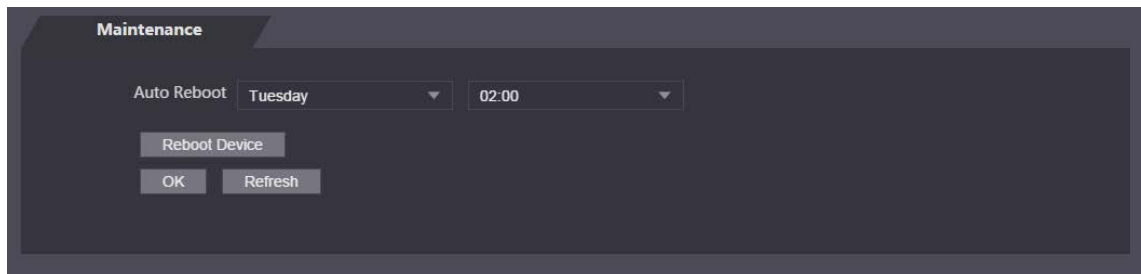

4.9.5 Configuration Management

When more than one access controller needs the same configuration, you can configure parameters for them by importing or exporting configuration files. See Figure 4-25.

Figure 4-25 Configuration management

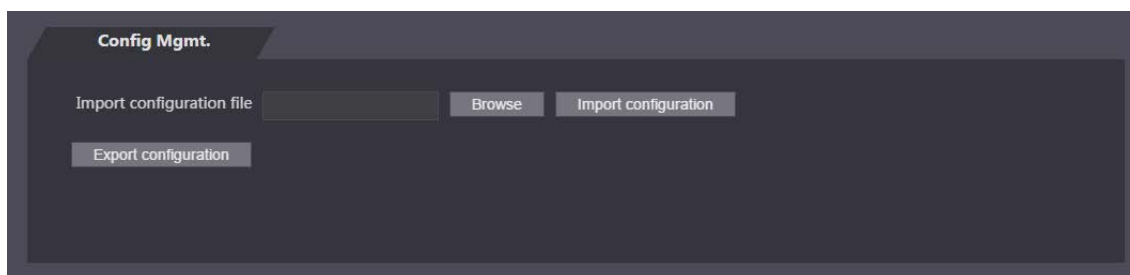

4.9.6 Upgrade

You can select **Auto Check** to upgrade the system automatically. You can also select **Manual Check** to upgrade the system manually.

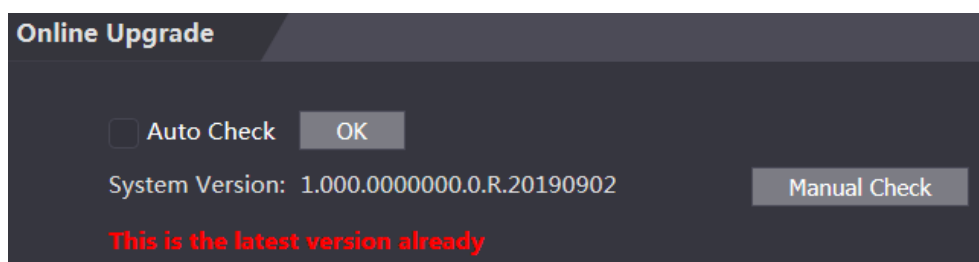

4.9.7 Version Information

You can view information including MAC address, serial number, MCU version, web version, security baseline version, and system version.

4.9.8 Online User

You can view username, IP address, and user login time on the **Online User** interface. See Figure 4-26.

Figure 4-26 Online user

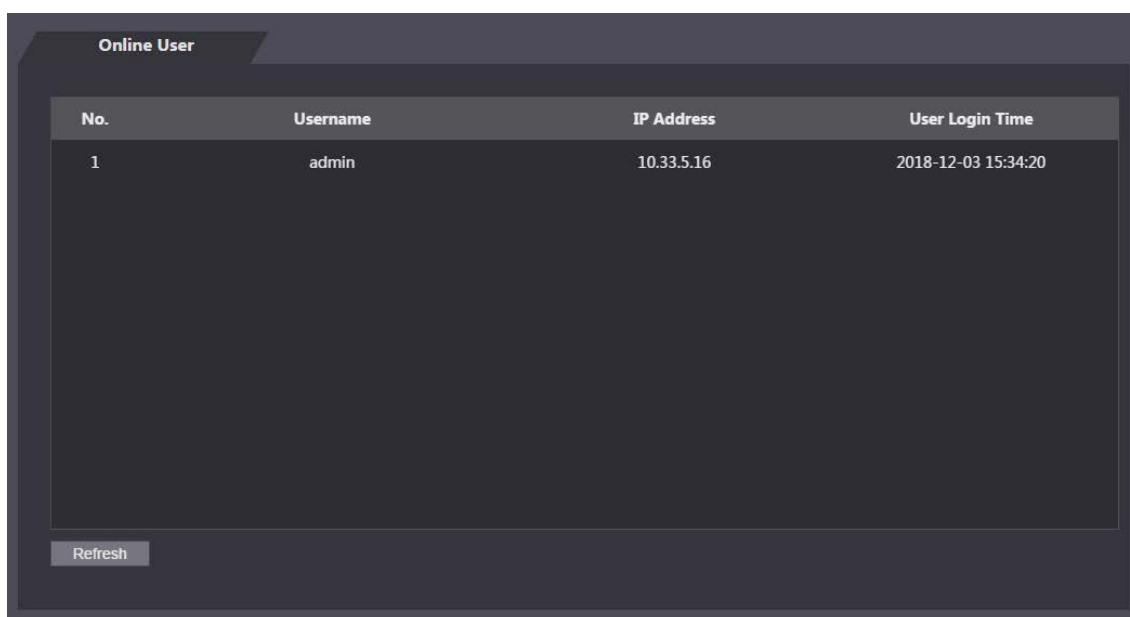

4.10 System Log

You can view and backup the system log on the **System Log** interface. See Figure 4-27.

Figure 4-27 System log

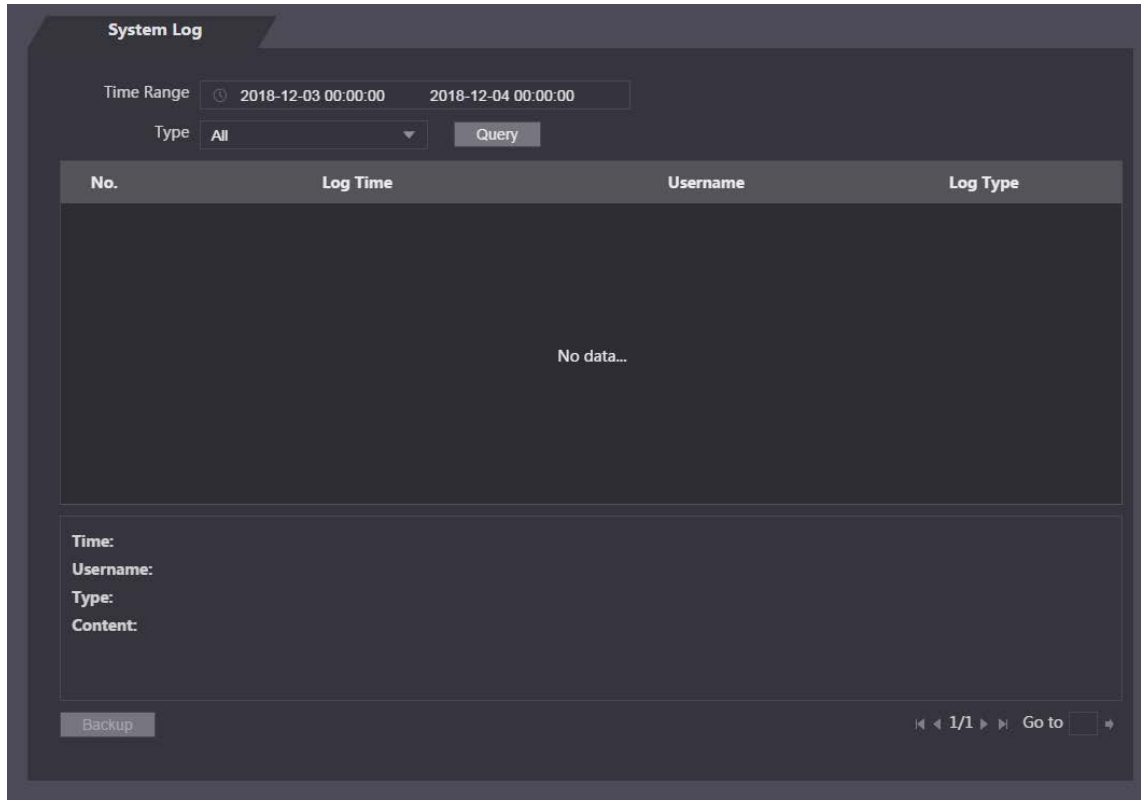

4.10.1 Querying Logs

Select a time range and its type, click **Query**, and logs meet the conditions will be displayed.

4.10.2 Backing up Logs

Click **Backup** to back up the logs displayed.

4.11 Admin Log

Enter Admin ID on the **Admin Log** interface, click **Query**, and then you will see the administrator's operation records. See Figure 4-28.

Figure 4-28 Admin log

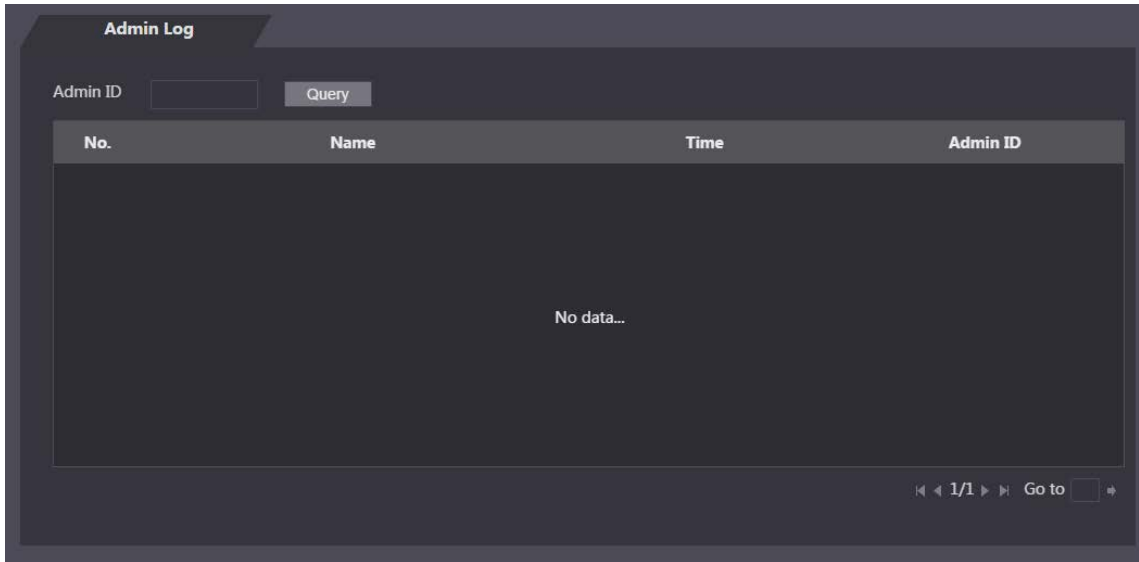

Hover the mouse cursor over , and then you can see detailed information of the current user.

4.12 Exit

Click , click **OK**, and then you will log out the web interface.

5 Smart PSS Configuration

You can do access permission configuration to a single door or door groups through the Smart PSS client. For detailed configurations, see the Smart PSS user manual.



Smart PSS interfaces might vary with versions, and the actual interface shall prevail.

5.1 Login

Install the Smart PSS (the default username is admin, and the default password is admin123), double-

click  to operate it. Follow the instructions to finish the initialization and log in.

5.2 Adding Devices

You need to add access controllers to the Smart PSS. You can click **Auto Search** to add and click **Add** to manually add devices.

5.2.1 Auto Search

You can search and add access controllers at the same network segment to the Smart PSS. See Figure 5-1 and Figure 5-2.

Figure 5-1 Devices

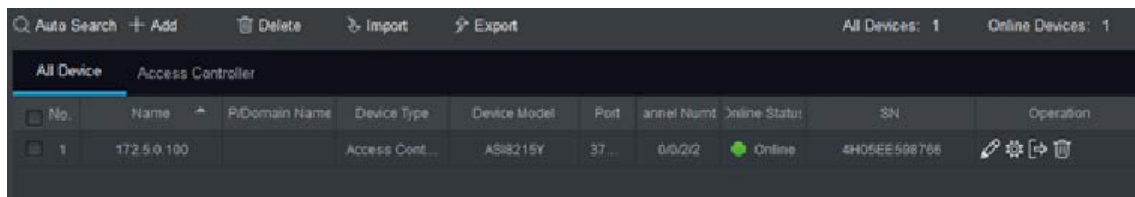



No.	Name	PiDomain Name	Device Type	Device Model	Port	Serial Num	Online Status	SN	Operation
1	172.5.0.100		Access Cont...	AS8215Y	37...	0/0/2/2	Online	4H05EE598756	  

Figure 5-2 Auto search



Step 1 Click **Auto Search**, enter the network segment, and then click Search. A list will be displayed.

Step 2 Select access controllers that you want to add to the Smart PSS, and then click Add, the Login information dialog box will be displayed.

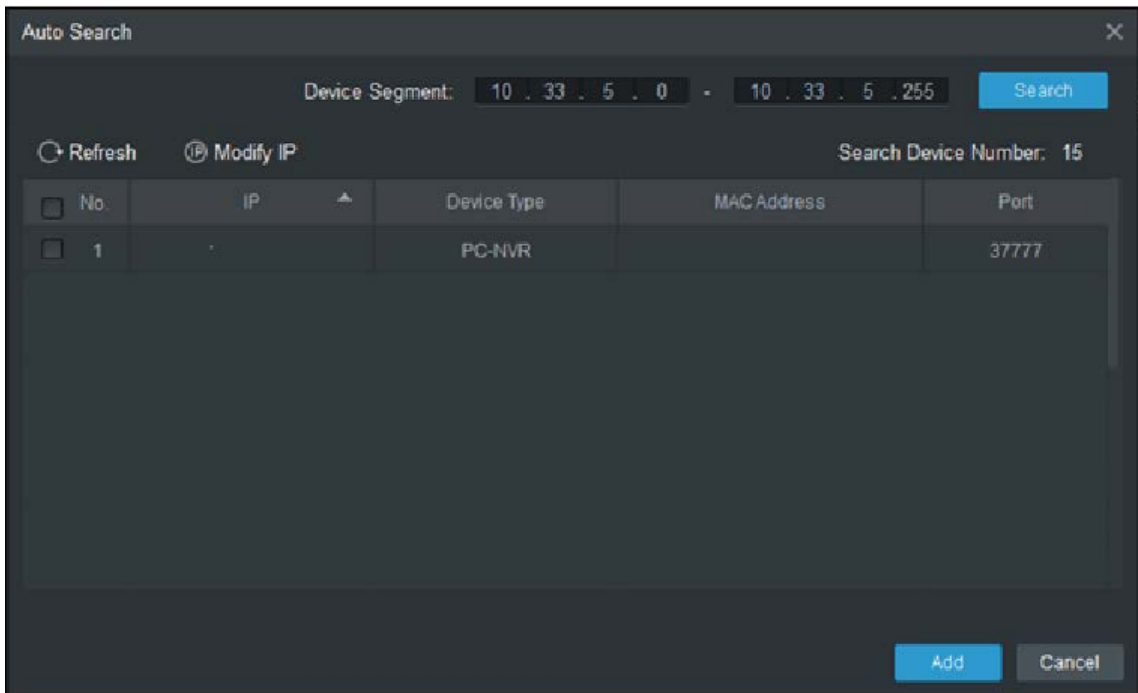
Step 3 Enter the username and the login password to login.

You can see the added access controller on the **Devices** interface.



Select an access controller, click **Modify IP**, and you can modify the access controller's IP address. For details about IP address modification, see Smart PSS user manual.

5.2.2 Manual Add

You need to know IP addresses and domain names of access controllers that you want to add. See Figure 5-3 and Figure 5-4.

Figure 5-3 Devices

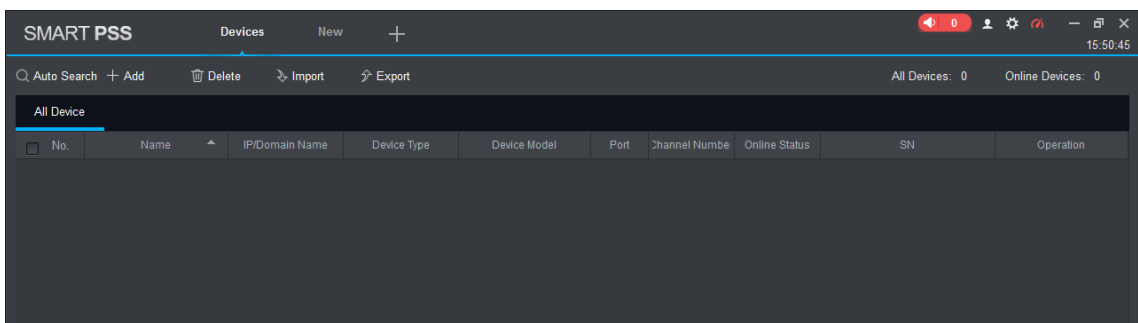

Figure 5-4 Manual add

Manual Add

Device Name: *

Method to add: IP/Domain

IP/Domain Name: *

Port: * 37777

Group Name: root

User Name: *

Password:

Save and ... Add Cancel

- Step 1** Click **Add** on the Devices interface, and the Manual Add interface will be displayed.
- Step 2** Enter the Device Name, select a method to add, enter the IP/Domain Name, Port number (37777 by default), Group Name, User Name, and Password.
- Step 3** Click **Add**, and then you can see the added access controller on the Devices interface.

5.3 Adding Users

Users are bound with cards. After you have added users to the Smart PSS, you can configure users access permissions on the **New > Access**. See Figure 5-5.

Figure 5-5 New

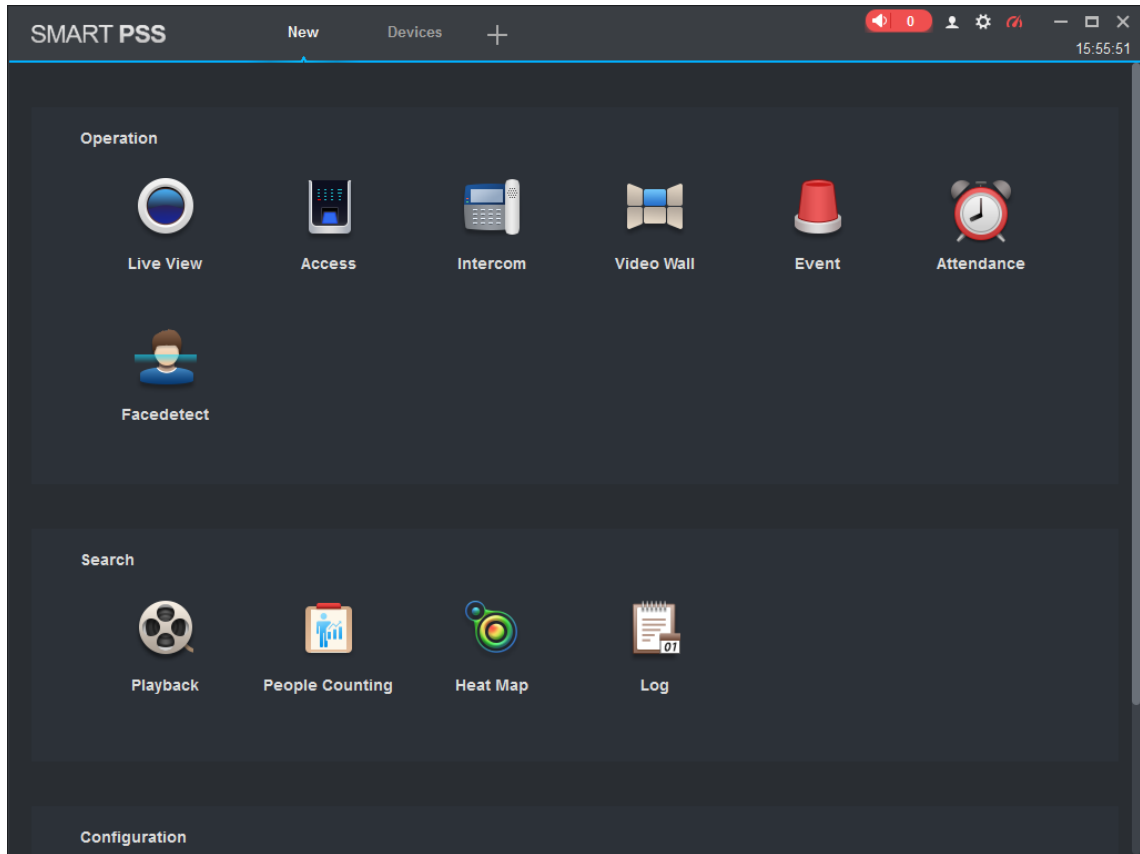

5.3.1 Card Type Selection



Card types must be the same as card issuer types; otherwise card numbers cannot be read.



On the **Access** interface, click , then click the IC or ID card icon, and then select a card type. There are two options: ID Card and IC Card. See Figure 5-6 and Figure 5-7.

Figure 5-6 Access

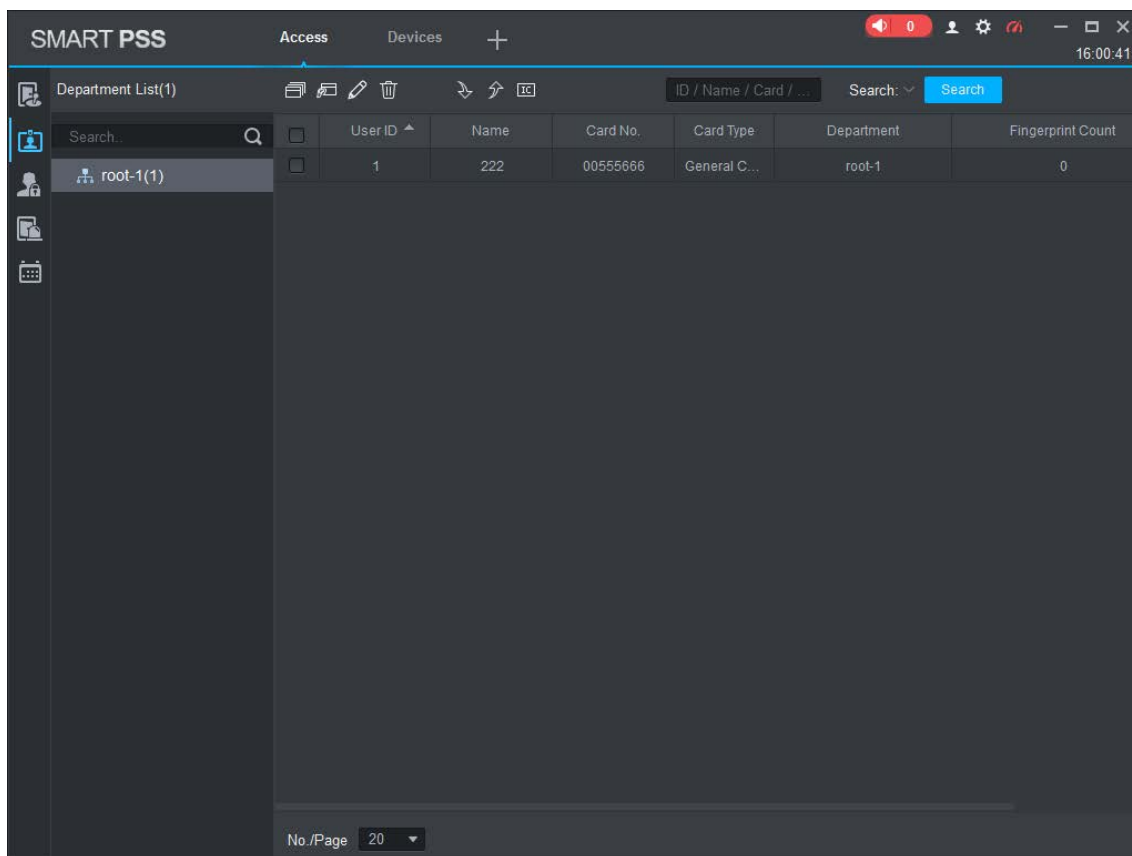
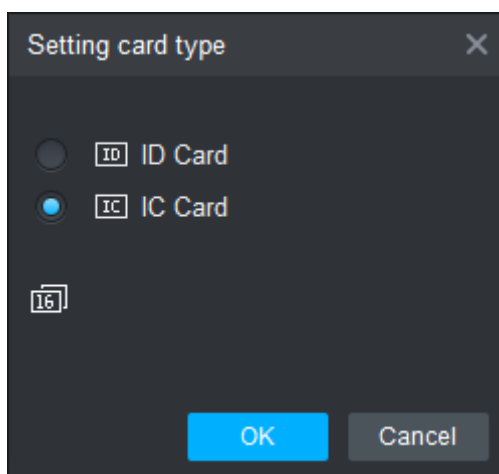

Figure 5-7 Setting card type



5.3.2 Adding One User

You can add users one by one.



On the **Access** interface, click , then click , and then enter user's information. Click **Finish** to complete the user adding. See Figure 5-8 and Figure 5-9.

Figure 5-8 Access

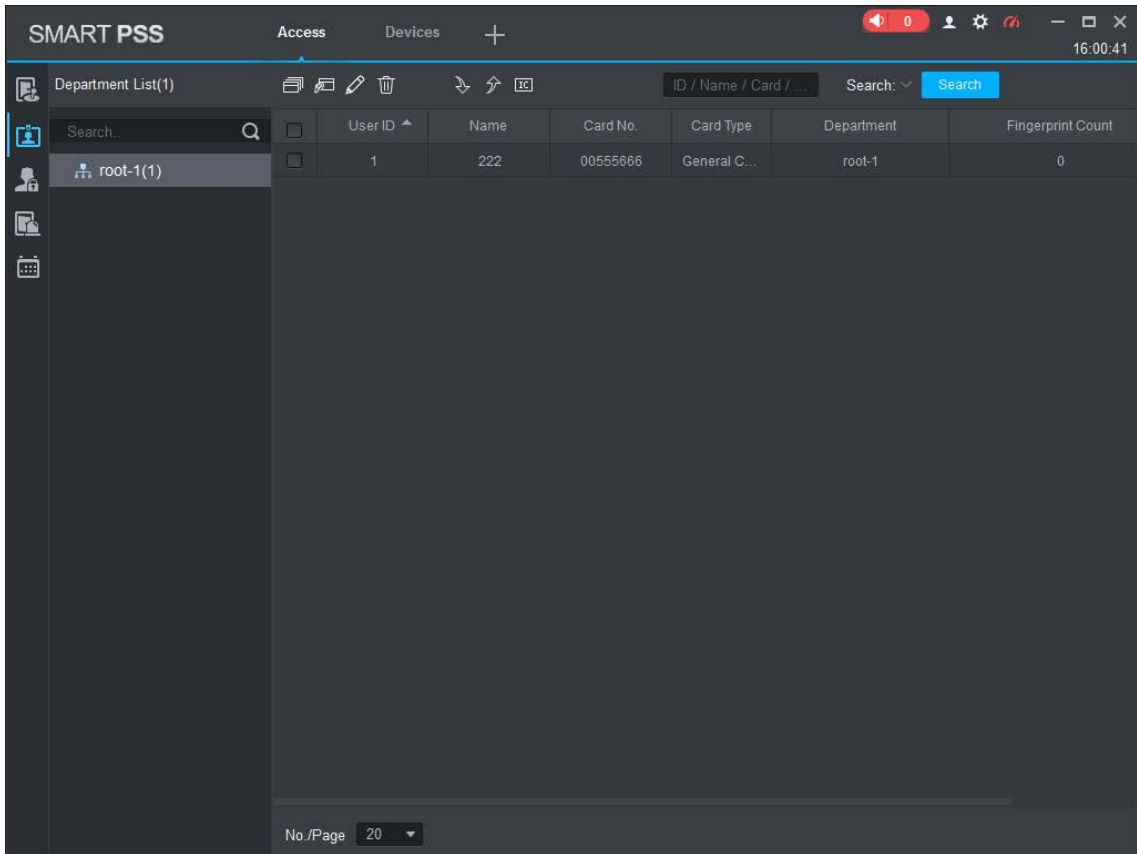
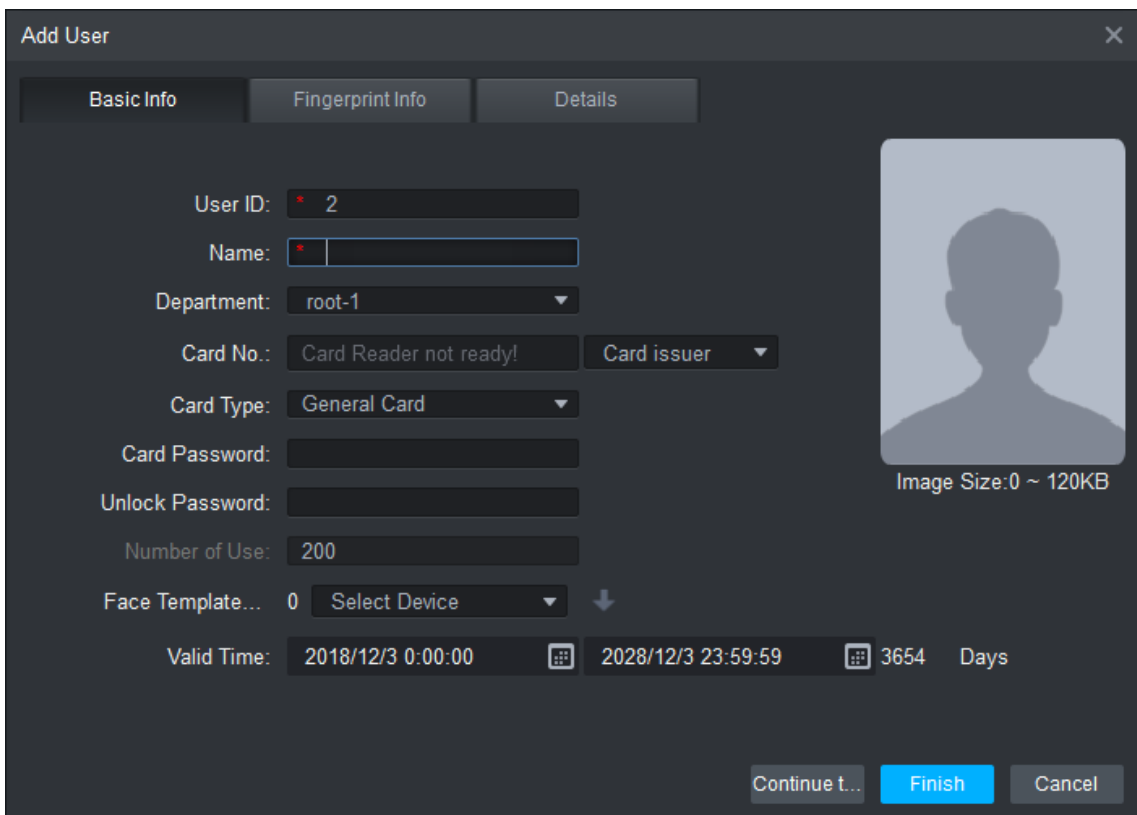

Figure 5-9 Add user



5.4 Adding Door Group

You can manage doors by grouping doors.

On the **Access** interface, click , click **Add**, enter door group name, and then select a time zone. Click **Finish** to complete the user adding. See Figure 5-10 and Figure 5-11.

Figure 5-10 Access

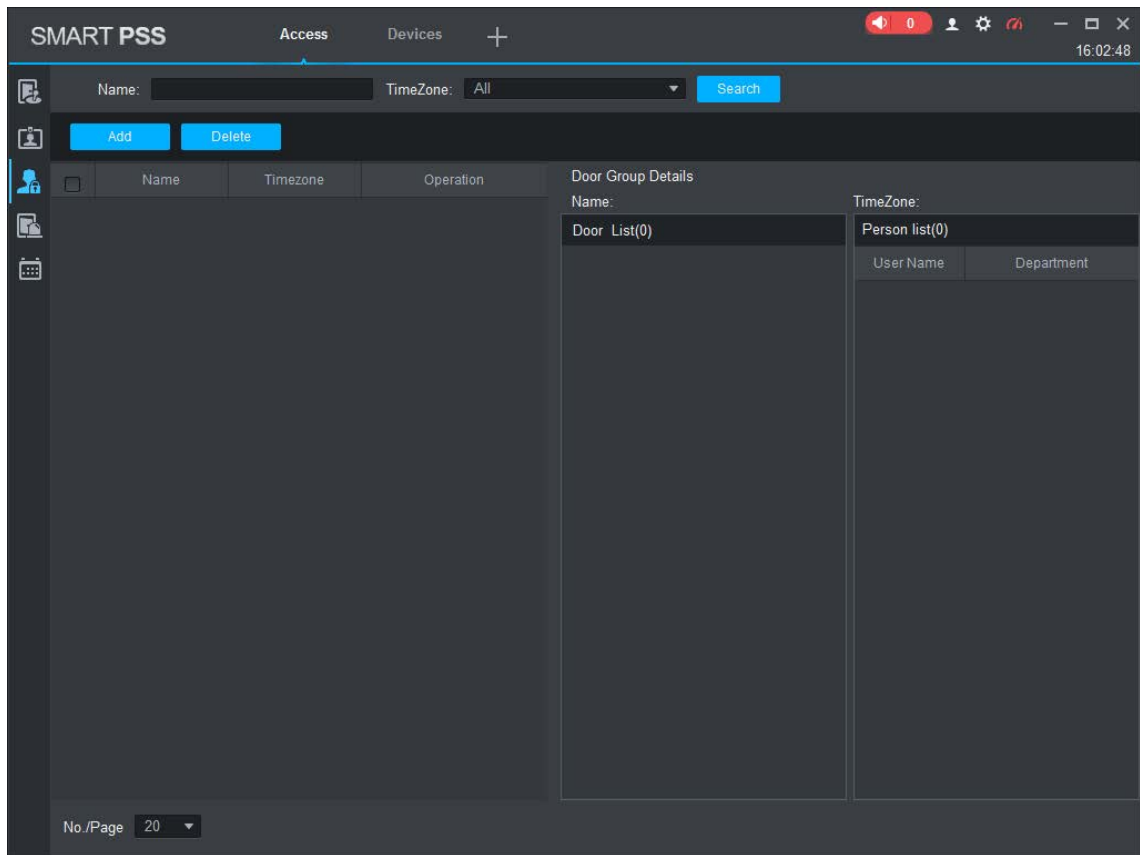
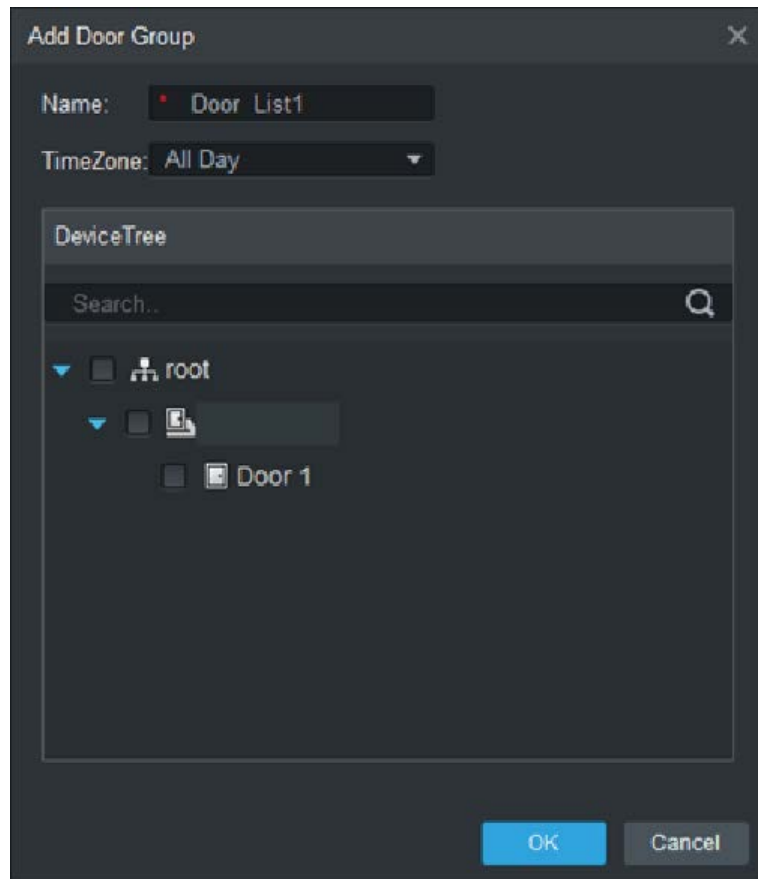

Figure 5-11 Add door group



5.5 Access Permission Configuration

You can do access permission configuration. There are two options: door group access permission and user access permission. Information of users who are given access permission in the Smart PSS and access controllers will be synchronized.

5.5.1 Giving Permission by Door Group

Select a door group, add users to the door list, and then users on the door list get access permissions of all doors on the door list. See Figure 5-12 and Figure 5-13.

Figure 5-12 Access

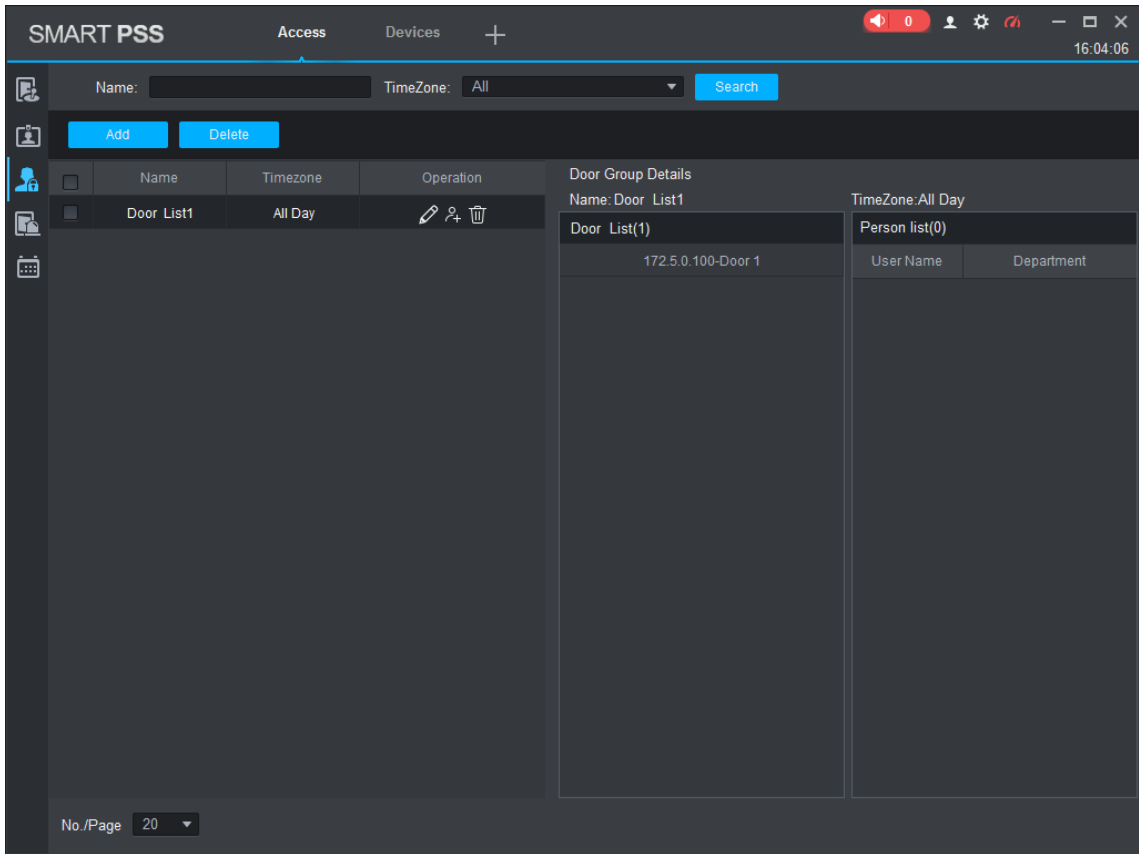
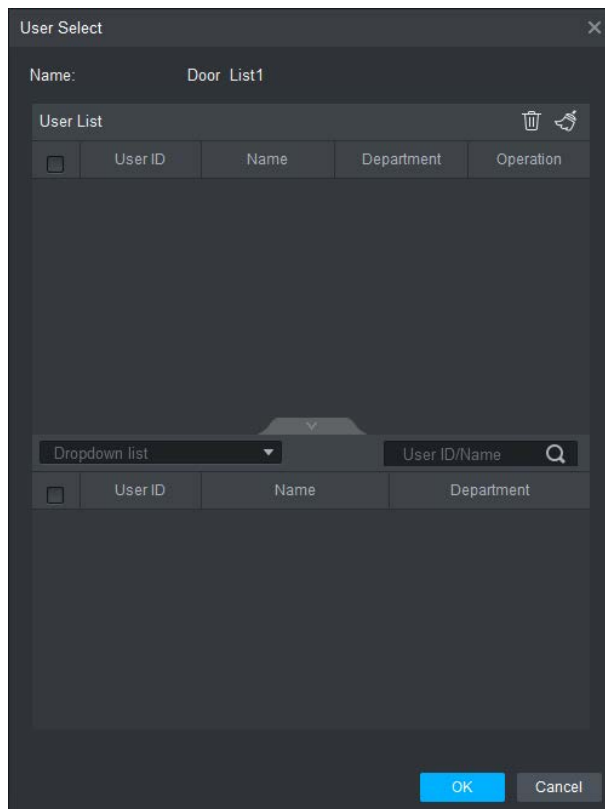



Figure 5-13 User select



Step 1 On the **Access** interface, click , click **Add**, and click **Door Group Permission**.

Step 2 Click . Select user department in the dropdown list, or enter user **ID/Name**, and then

search users. Select users from the users you found.

Step 3 Click **Finish** to complete the configuration.



Users without user ID cannot be found.

5.5.2 Giving Permission by User ID

You can give access permission to a user by selecting a user, and then select door groups for the user. See Figure 5-14 and Figure 5-15.

Figure 5-14 Access

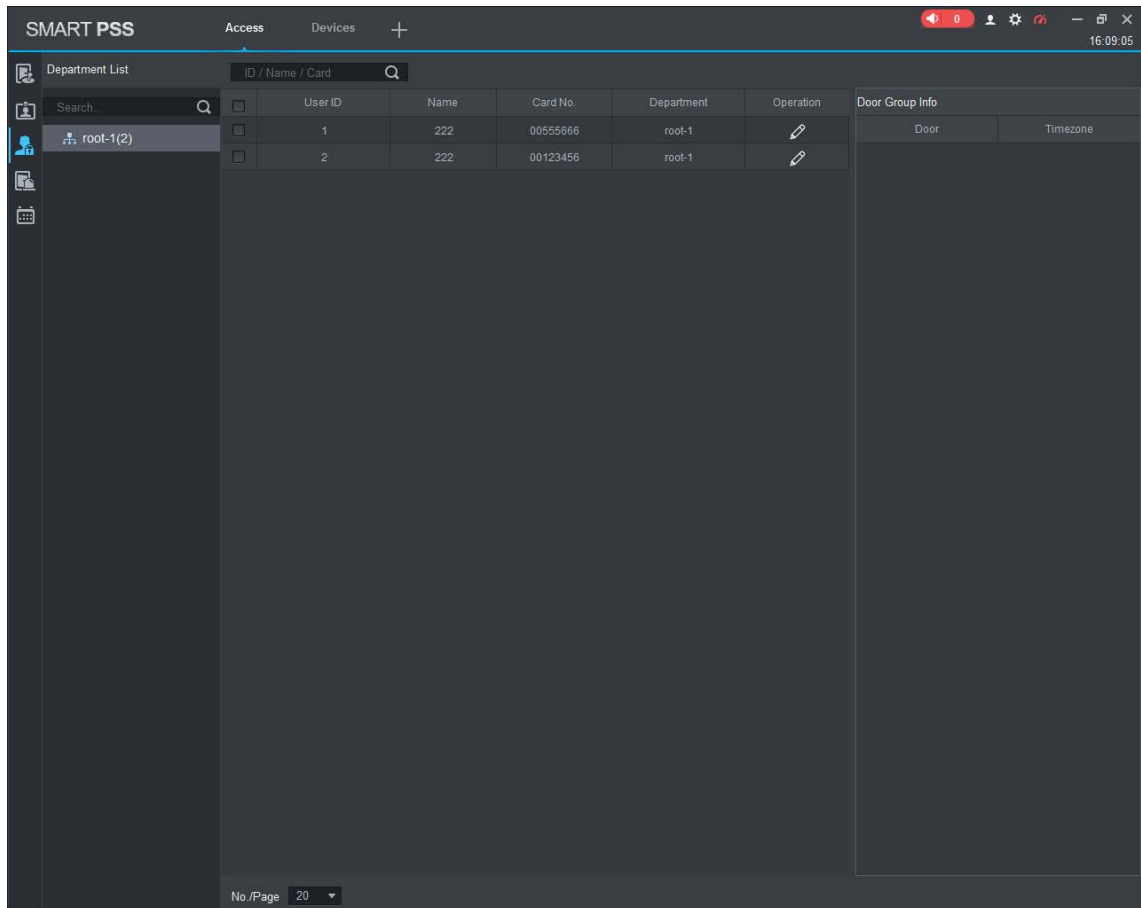
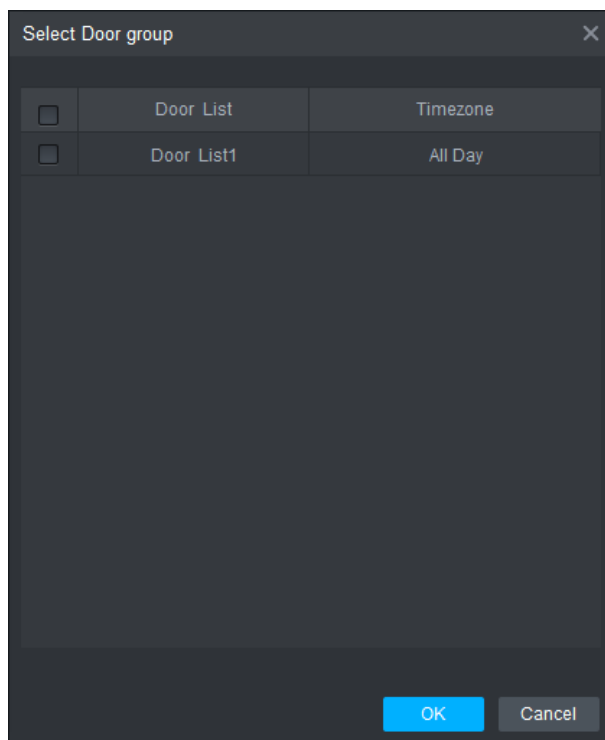



Figure 5-15 Select door group



- Step 1 On the **Access** interface, click .
- Step 2 Click . The Select Door Group interface is displayed.
- Step 3 Select user department in the dropdown list, or enter user ID/Name, and then select a door list.
- Step 4 Click Finish to complete the configuration.

Appendix 1 Cybersecurity Recommendations

Mandatory actions to be taken for basic device network security:

1. Use Strong Passwords

Please refer to the following suggestions to set passwords:

- The length should not be less than 8 characters.
- Include at least two types of characters; character types include upper and lower case letters, numbers and symbols.
- Do not contain the account name or the account name in reverse order.
- Do not use continuous characters, such as 123, abc, etc.
- Do not use overlapped characters, such as 111, aaa, etc.

2. Update Firmware and Client Software in Time

- According to the standard procedure in Tech-industry, we recommend to keep your device (such as NVR, DVR, IP camera, etc.) firmware up-to-date to ensure the system is equipped with the latest security patches and fixes. When the device is connected to the public network, it is recommended to enable the "auto-check for updates" function to obtain timely information of firmware updates released by the manufacturer.
- We suggest that you download and use the latest version of client software.

"Nice to have" recommendations to improve your device network security:

1. Physical Protection

We suggest that you perform physical protection to device, especially storage devices. For example, place the device in a special computer room and cabinet, and implement well-done access control permission and key management to prevent unauthorized personnel from carrying out physical contacts such as damaging hardware, unauthorized connection of removable device (such as USB flash disk, serial port), etc.

2. Change Passwords Regularly

We suggest that you change passwords regularly to reduce the risk of being guessed or cracked.

3. Set and Update Passwords Reset Information Timely

The device supports password reset function. Please set up related information for password reset in time, including the end user's mailbox and password protection questions. If the information changes, please modify it in time. When setting password protection questions, it is suggested not to use those that can be easily guessed.

4. Enable Account Lock

The account lock feature is enabled by default, and we recommend you to keep it on to guarantee the account security. If an attacker attempts to log in with the wrong password several times, the corresponding account and the source IP address will be locked.

5. Change Default HTTP and Other Service Ports

We suggest you to change default HTTP and other service ports into any set of numbers between 1024–65535, reducing the risk of outsiders being able to guess which ports you are using.

6. Enable HTTPS

We suggest you to enable HTTPS, so that you visit Web service through a secure communication channel.

7. MAC Address Binding

We recommend you to bind the IP and MAC address of the gateway to the device, thus reducing the risk of ARP spoofing.

8. Assign Accounts and Privileges Reasonably

According to business and management requirements, reasonably add users and assign a minimum set of permissions to them.

9. Disable Unnecessary Services and Choose Secure Modes

If not needed, it is recommended to turn off some services such as SNMP, SMTP, UPnP, etc., to reduce risks.

If necessary, it is highly recommended that you use safe modes, including but not limited to the following services:

- SNMP: Choose SNMP v3, and set up strong encryption passwords and authentication passwords.
- SMTP: Choose TLS to access mailbox server.
- FTP: Choose SFTP, and set up strong passwords.
- AP hotspot: Choose WPA2-PSK encryption mode, and set up strong passwords.

10. Audio and Video Encrypted Transmission

If your audio and video data contents are very important or sensitive, we recommend that you use encrypted transmission function, to reduce the risk of audio and video data being stolen during transmission.

Reminder: encrypted transmission will cause some loss in transmission efficiency.

11. Secure Auditing

- Check online users: we suggest that you check online users regularly to see if the device is logged in without authorization.
- Check device log: By viewing the logs, you can know the IP addresses that were used to log in to your devices and their key operations.

12. Network Log

Due to the limited storage capacity of the device, the stored log is limited. If you need to save the log for a long time, it is recommended that you enable the network log function to ensure that the critical logs are synchronized to the network log server for tracing.

13. Construct a Safe Network Environment

In order to better ensure the safety of device and reduce potential cyber risks, we recommend:

- Disable the port mapping function of the router to avoid direct access to the intranet devices from external network.
- The network should be partitioned and isolated according to the actual network needs. If there are no communication requirements between two sub networks, it is suggested to use VLAN, network GAP and other technologies to partition the network, so as to achieve the network isolation effect.
- Establish the 802.1x access authentication system to reduce the risk of unauthorized access to private networks.
- Enable IP/MAC address filtering function to limit the range of hosts allowed to access the device.