



**SGS-CSTC Standards Technical Services
(Shanghai) Co., Ltd.**

588 West Jindu Road, Xinqiao, Songjiang, 201612 Shanghai, China
 Telephone: +86 (0) 21 6191 5666
 Fax: +86 (0) 21 6191 5678
 ee.shanghai@sgs.com

Report No.: SHEM180400277401
 Page: 1 of 108

TEST REPORT

Application No.: SHEM1804002774IT
Applicant: Hangzhou Hikvision Digital Technology Co., Ltd.
Address of Applicant: No. 555 Qianmo Road, Binjiang District, Hangzhou 310052, China
Manufacturer: Hangzhou Hikvision Digital Technology Co., Ltd.
Address of Manufacturer: No. 555 Qianmo Road, Binjiang District, Hangzhou 310052, China
Factory: 1. Hangzhou Hikvision Technology Co., Ltd.
 2. Hangzhou Hikvision Electronics Co., Ltd.
Address of Factory: 1. No. 700, Dongliu Road, Binjiang District, Hangzhou City, Zhejiang, 310052, China
 2. No. 299, Qiushi Road, Tonglu Economic Development Zone, Tonglu County, Hangzhou, Zhejiang, 310052, China.

Equipment Under Test (EUT):

EUT Name: Network Camera
Model No.: DS-2CD2623G0-IZS, DS-2CD2643G0-IZS, DS-2CD2683G0-IZS, DS-2CD2663G0-IZS*

* Please refer to section 2 of this report which indicates which model was actually tested and which were electrically identical.

Trade mark: HIKVISION
Standard(s) : EN 55032:2015, EN 50130-4:2011 +A1:2014
 EN 61000-3-2:2014, EN 61000-3-3:2013

Date of Receipt: 2017-12-18 & 2018-04-17
Date of Test: 2017-12-21 to 2017-12-26 & 2018-04-17 to 2018-04-19
Date of Issue: 2018-05-11

Test Result:	Pass*
---------------------	--------------

* In the configuration tested, the EUT complied with the standards specified above.

The CE mark as shown below can be used, under the responsibility of the manufacturer, after completion of an EU Declaration of Conformity and compliance with all relevant EU Directives.



Parlam Zhan
 E&E Section Manager

The manufacturer should ensure that all products in series production are in conformity with the product sample detailed in this report. If the product in this report is used in any configuration other than that detailed in the report, the manufacturer must ensure the new system complies with all relevant standards. Any mention of SGS International Electrical Approvals or testing done by SGS International Electrical Approvals in connection with, distribution or use of the product described in this report must be approved by SGS International Electrical Approvals in writing.

This document is issued by the Company subject to its General Conditions of Service printed overleaf, available on request or accessible at <http://www.sgs.com/en/Terms-and-Conditions.aspx> and, for electronic format documents, subject to Terms and Conditions for Electronic Documents at <http://www.sgs.com/en/Terms-and-Conditions/Terms-e-Document.aspx>. Attention is drawn to the limitation of liability, indemnification and jurisdiction issues defined therein. Any holder of this document is advised that information contained hereon reflects the Company's findings at the time of its intervention only and within the limits of Client's instructions, if any. The Company's sole responsibility is to its Client and this document does not exonerate parties to a transaction from exercising all their rights and obligations under the transaction documents. This document cannot be reproduced except in full, without prior written approval of the Company. Any unauthorized alteration, forgery or falsification of the content or appearance of this document is unlawful and offenders may be prosecuted to the fullest extent of the law. Unless otherwise stated the results shown in this test report refer only to the sample(s) tested and such sample(s) are retained for 30 days only.





SGS-CSTC Standards Technical Services (Shanghai) Co., Ltd.

Report No.: SHEM180400277401

Page: 2 of 108

Revision Record			
Version	Description	Date	Remark
00	Add models and test data	2018-05-11	Based onSHEM171200867501

Authorized for issue by:			
			
		<hr/>	
		Bruce Tang /Project Engineer	
			
		<hr/>	
		Zenger Zhang /Reviewer	

2 Test Summary

Emission Part				
Item	Standard	Method	Requirement	Result
Conducted Emissions at Mains Terminals (150kHz-30MHz)	EN 55032:2015	EN 55032:2015	Class B	Pass
Asymmetric Mode Conducted Emissions (150kHz-30MHz)	EN 55032:2015	EN 55032:2015	Class B	Pass
Radiated Emissions (30MHz-1GHz)	EN 55032:2015	EN 55032:2015	Class B	Pass
Radiated Emissions (above 1GHz)	EN 55032:2015	EN 55032:2015	Class B	Pass
Harmonic Current Emission	EN 61000-3-2:2014	EN 61000-3-2:2014	Class A	N/A
Voltage Fluctuations and Flicker	EN 61000-3-3:2013	EN 61000-3-3:2013	Clause 5 of EN 61000-3-3	Pass

N/A: Please refer to Section 6.5 of this report for details.

Immunity Part				
Item	Standard	Method	Requirement	Result
Electrostatic Discharge	EN 50130-4:2011 +A1:2014	EN 61000-4-2:2009	6kV Contact Discharge 2,4,8kV Air Discharge	Pass
Electrical Fast Transients/Burst at Power Port	EN 50130-4:2011 +A1:2014	EN 61000-4-4:2012	2kV5/50ns Tr/Td100kHz Repetition Frequency	Pass
Electrical Fast Transients/Burst at Signal Port	EN 50130-4:2011 +A1:2014	EN 61000-4-4:2012	1kV5/50ns Tr/Td100kHz Repetition Frequency	Pass
Surge at Power Port	EN 50130-4:2011 +A1:2014	EN 61000-4-5:2014	1.2/50µs Tr/Td0.5,1kV Line to Line 0.5,1,2kV Line to Ground	Pass
Surge at Signal Port	EN 50130-4:2011 +A1:2014	EN 61000-4-5:2014	1.2/50µs Tr/Td0.5,1kV Line to Ground	Pass
Voltage Dips and Interruptions	EN 50130-4:2011 +A1:2014	EN 61000-4-11:2004	80 % UT for 25per70 % UT for 25per40 % UT for 10per0 % UT for 250perUT is Supply Voltage	Pass
Mains Supply Voltage Variations-Conditioning	EN 50130-4:2011 +A1:2014	EN 50130-4:2011+A1:2014	Unom+10%Unom-15%	Pass
Radiated Immunity(80MHz-2.7GHz)	EN 50130-4:2011 +A1:2014	EN 61000-4-3:2006 +A1:2008+A2:2010	10V/m, 80%, 1kHz sinusoidal Amp. Mod.	Pass
Conducted Immunity at Power Port (150kHz-100MHz)	EN 50130-4:2011 +A1:2014	EN 61000-4-6:2014	10Vrms (emf),80%,1kHz sinusoidal Amp. Mod.	Pass



SGS-CSTC Standards Technical Services (Shanghai) Co., Ltd.

Report No.: SHEM180400277401

Page: 4 of 108

Immunity Part				
Item	Standard	Method	Requirement	Result
Conducted Immunity at Signal Port (150kHz-100MHz)	EN 50130-4:2011 +A1:2014	EN 61000-4-6:2014	10Vrms (emf),80%,1kHz sinusoidal Amp. Mod.	Pass

InternalSource	UpperFrequency
Below 108MHz	1GHz
108MHz to 500MHz	2GHz
500MHz to 1GHz	5GHz
Above 1GHz	5 times the highest frequency or 6 GHz, whichever is less

Note1: Declaration of EUT Family Grouping:

There are series models mentioned in this report and they are the similar in electrical and electronic characters. Only the model DS-2CD2623G0-IZS was tested since their differences are software version, their naming and color, silk.

Note2 : We add models DS-2CD2683G0-IZS, DS-2CD2663G0-IZS in this report. The new models mentioned in this report are the same as the original models, in Electronic or Electrical characters. Which were already EMC tested in the report SHEM171200867501. So the new models in this report are deemed to fulfil the EMC requirements without testing



3 Contents

	Page
1 COVER PAGE	1
2 TEST SUMMARY	3
3 CONTENTS	5
4 GENERAL INFORMATION	7
4.1 DETAILS OF E.U.T.	7
4.2 DESCRIPTION OF SUPPORT UNITS	7
4.3 MEASUREMENT UNCERTAINTY	7
4.4 TEST LOCATION	8
4.5 TEST FACILITY	8
4.6 DEVIATION FROM STANDARDS.....	8
4.7 ABNORMALITIES FROM STANDARD CONDITIONS	8
4.8 MONITORING OF EUT FOR ALL IMMUNITY TEST.....	8
5 EQUIPMENT LIST	9
6 EMISSION TEST RESULTS	16
6.1 CONDUCTED EMISSIONS AT MAINS TERMINALS (150KHZ-30MHZ).....	16
6.1.1 <i>E.U.T. Operation</i>	16
6.1.2 <i>Test Setup Diagram</i>	16
6.1.3 <i>Measurement Data</i>	16
6.2 ASYMMETRIC MODE CONDUCTED EMISSIONS (150KHZ-30MHZ).....	29
6.2.1 <i>E.U.T. Operation</i>	29
6.2.2 <i>Test Setup Diagram</i>	29
6.2.3 <i>Measurement Data</i>	29
6.3 RADIATED EMISSIONS (30MHZ-1GHZ).....	36
6.3.1 <i>E.U.T. Operation</i>	36
6.3.2 <i>Test Setup Diagram</i>	36
6.3.3 <i>Measurement Data</i>	36
6.4 RADIATED EMISSIONS (ABOVE 1GHZ)	49
6.4.1 <i>E.U.T. Operation</i>	49
6.4.2 <i>Test Setup Diagram</i>	49
6.4.3 <i>Measurement Data</i>	49
6.5 HARMONIC CURRENT EMISSION	62
6.6 VOLTAGE FLUCTUATIONS AND FLICKER	63
6.6.1 <i>E.U.T. Operation</i>	63
6.6.2 <i>Test Setup Diagram</i>	63
6.6.3 <i>Measurement Data</i>	63
7 IMMUNITY TEST RESULTS	66
7.1 PERFORMANCE CRITERIA DESCRIPTION IN EN 50130-4:2011 +A1:2014	66
7.2 ELECTROSTATIC DISCHARGE	67
7.2.1 <i>Test Setup Diagram</i>	67
7.2.2 <i>E.U.T. Operation</i>	67
7.2.3 <i>Test Results:</i>	67
7.3 ELECTRICAL FAST TRANSIENTS/BURST AT POWER PORT	68
7.3.1 <i>Test Setup Diagram</i>	68
7.3.2 <i>E.U.T. Operation</i>	68



7.3.3	Test Results:.....	68
7.4	ELECTRICAL FAST TRANSIENTS/BURST AT SIGNAL PORT	69
7.4.1	Test Setup Diagram	69
7.4.2	E.U.T. Operation	69
7.4.3	Test Results:.....	69
7.5	SURGE AT POWER PORT	70
7.5.1	Test Setup Diagram	70
7.5.2	E.U.T. Operation	70
7.5.3	Test Results:.....	70
7.6	SURGE AT SIGNAL PORT.....	72
7.6.1	Test Setup Diagram	72
7.6.2	E.U.T. Operation	72
7.6.3	Test Results:.....	72
7.7	VOLTAGE DIPS AND INTERRUPTIONS	73
7.7.1	Test Setup Diagram	73
7.7.2	E.U.T. Operation	73
7.7.3	Test Results:.....	73
7.8	MAINS SUPPLY VOLTAGE VARIATIONS-CONDITIONING.....	74
7.8.1	Test Setup Diagram	74
7.8.2	E.U.T. Operation	74
7.8.3	Test Results:.....	74
7.9	RADIATED IMMUNITY(80MHZ-2.7GHZ).....	75
7.9.1	Test Setup Diagram	75
7.9.2	E.U.T. Operation	75
7.9.3	Test Results:.....	75
7.10	CONDUCTED IMMUNITY AT POWER PORT (150KHZ-100MHZ).....	76
7.10.1	Test Setup Diagram.....	76
7.10.2	E.U.T. Operation.....	76
7.10.3	Test Results:.....	76
7.11	CONDUCTED IMMUNITY AT SIGNAL PORT (150KHZ-100MHZ)	77
7.11.1	Test Setup Diagram.....	77
7.11.2	E.U.T. Operation.....	77
7.11.3	Test Results:.....	77
8	PHOTOGRAPHS.....	78
8.1	CONDUCTED EMISSIONS AT MAINS TERMINALS (150KHZ-30MHZ) TEST SETUP.....	78
8.2	ASYMMETRIC MODE CONDUCTED EMISSIONS (150KHZ-30MHZ) TEST SETUP	79
8.3	RADIATED EMISSIONS (30MHZ-1GHZ) TEST SETUP	80
8.4	RADIATED EMISSIONS (ABOVE 1GHZ) TEST SETUP.....	81
8.5	VOLTAGE FLUCTUATIONS AND FLICKER TEST SETUP	82
8.6	ELECTROSTATIC DISCHARGE TEST SETUP	83
8.7	ELECTRICAL FAST TRANSIENTS/BURST AT POWER PORT TEST SETUP	84
8.8	ELECTRICAL FAST TRANSIENTS/BURST AT SIGNAL PORT TEST SETUP.....	85
8.9	SURGE AT POWER PORT TEST SETUP.....	86
8.10	SURGE AT SIGNAL PORT TEST SETUP	87
8.11	VOLTAGE DIPS AND INTERRUPTIONS TEST SETUP.....	88
8.12	MAINS SUPPLY VOLTAGE VARIATIONS-CONDITIONING TEST SETUP.....	89
8.13	RADIATED IMMUNITY(80MHZ-2.7GHZ) TEST SETUP	90
8.14	CONDUCTED IMMUNITY AT POWER PORT (150KHZ-100MHZ) TEST SETUP.....	91
8.15	CONDUCTED IMMUNITY AT SIGNAL PORT (150KHZ-100MHZ) TEST SETUP	92
8.16	EUT CONSTRUCTIONAL DETAILS	93-108

4 General Information

4.1 Details of E.U.T.

Power supply:	DC12V or PoE
---------------	--------------

4.2 Description of Support Units

The EUT has been tested as an independent unit.

4.3 Measurement Uncertainty

No.	Item	Measurement Uncertainty
1	Conducted Emission at mains port using AMN	3.2dB (9kHz to 150kHz)
		3.0dB (150kHz to 30MHz)
2	Conducted Emission at mains port using VP	1.9 dB(9kHz to 30MHz)
3	Conducted Emission at telecommunication port using AAN	2.4 dB(150kHz to 30MHz)
4	Radiated Power	3.5dB
5	Radiated emission	4.4dB (30MHz-1GHz)
		4.6dB (1GHz-6GHz)

Note: The measurement uncertainty represents an expanded uncertainty expressed at approximately the 95% confidence level using a coverage factor of k=2.

4.4 Test Location

All tests were performed at:

SGS-CSTC Standards Technical Services (Shanghai) Co., Ltd. E&E Lab

588 West Jindu Road, Xinqiao, Songjiang, 201612 Shanghai, China

Tel: +86 21 6191 5666 Fax: +86 21 6191 5678

No tests were sub-contracted.

4.5 Test Facility

The test facility is recognized, certified, or accredited by the following organizations:

- **CNAS (No. CNAS L0599)**

CNAS has accredited SGS-CSTC Standards Technical Services (Shanghai) Co., Ltd. to ISO/IEC 17025:2005 General Requirements for the Competence of Testing and Calibration Laboratories (CNAS-CL01 Accreditation Criteria for the Competence of Testing and Calibration Laboratories) for the competence in the field of testing.

- **NVLAP (Certificate No. 201034-0)**

SGS-CSTC Standards Technical Services (Shanghai) Co., Ltd. is accredited by the National Voluntary Laboratory Accreditation Program(NVLAP). Certificate No. 201034-0.

- **FCC –Designation Number: CN5033**

SGS-CSTC Standards Technical Services (Shanghai) Co., Ltd. has been recognized as an accredited testing laboratory.

Designation Number: CN5033. Test Firm Registration Number: 479755.

- **Industry Canada (IC) – IC Assigned Code: 8617A**

The 3m Semi-anechoic chamber of SGS-CSTC Standards Technical Services (Shanghai) Co., Ltd. has been registered by Certification and Engineering Bureau of Industry Canada for radio equipment testing with Registration No.: 8617A-1.

- **VCCI (Member No.: 3061)**

The 3m Semi-anechoic chamber and Shielded Room of SGS-CSTC Standards Technical Services (Shanghai) Co., Ltd. has been registered in accordance with the Regulations for Voluntary Control Measures with Registration No.: R-3868,C-4336,T-12221,G-10830 respectively

4.6 Deviation from Standards

None

4.7 Abnormalities from Standard Conditions

None

4.8 Monitoring of EUT for All Immunity Test

Visual: work status and video quality



5 Equipment List

For old model

Conducted Emissions at Mains Terminals (150kHz-30MHz)					
Equipment	Manufacturer	Model No	Inventory No	Cal Date	Cal Due Date
EMI test receiver	Rohde & Schwarz	ESR7	SHEM162-1	2016-12-29	2017-12-28
Line impedance stabilization network	SCHWARZBECK	NSLK8127	SHEM061-1	2017-05-17	2018-05-16
Line impedance stabilization network	EMCO	3816/2	SHEM019-1	2016-12-29	2017-12-28
Pulse limiter	Rohde & Schwarz	ESH3-Z2	SHEM029-1	2017-08-01	2018-07-31
Shielding Room	ZHONGYU	8*4*3M	SHEM079-2	2016-12-29	2017-12-28
CE test Cable	/	/	CE01	2016-12-29	2017-12-28

Asymmetric Mode Conducted Emissions (150kHz-30MHz)					
Equipment	Manufacturer	Model No	Inventory No	Cal Date	Cal Due Date
EMI test receiver	Rohde & Schwarz	ESR7	SHEM162-1	2016-12-29	2017-12-28
Line impedance stabilization network	SCHWARZBECK	NSLK8127	SHEM061-1	2017-05-17	2018-05-16
8-wire ISN cat 5	SCHWARZBECK	CAT5 8158	SHEM137-1	2016-12-29	2017-12-28
8-wire ISN cat 3	SCHWARZBECK	CAT3 8158	SHEM137-2	2016-12-29	2017-12-28
8-wire ISNcat 6	SCHWARZBECK	NTFM8158	SHEM137-3	2016-12-29	2017-12-28
2-Draht ISN	Schwarzbeck - Mess-Elektronik	NTFM 8131	SHEM139-1	2016-12-29	2017-12-28
CE test Cable	/	/	CE01	2016-12-29	2017-12-28

Radiated Emissions (30MHz-1GHz)					
Equipment	Manufacturer	Model No	Inventory No	Cal Date	Cal Due Date
EMI test receiver	Rohde & Schwarz	ESU40	SHEM051-1	2017-09-26	2018-09-25
CONTROLLER	INNCO	CO200	SHEM047-1	N/A	N/A
ANTENNA MAST	INNCO	MA400-EP	SHEM047-2	N/A	N/A
TURN DEVICE	INNCO	DE 3600-RH	SHEM047-3	N/A	N/A
Broadband UHF-VHF ANTENNA	SCHWARZBECK	VULB9168	SHEM048-1	2017-02-28	2018-02-27
Semi/Fully Anechoic	ST	11*6*6M	SHEM078-2	2017-07-22	2018-07-21
Low Amplifier	CLAVIO	BDLNA-0001-412010	SHEM164-1	2017-08-22	2018-08-21



SGS-CSTC Standards Technical Services (Shanghai) Co., Ltd.

Report No.: SHEM180400277401

Page: 10 of 108

Radiated Emissions (above 1GHz)					
Equipment	Manufacturer	Model No	Inventory No	Cal Date	Cal Due Date
EML test receiver	Rohde & Schwarz	ESU40	SHEM051-1	2017-09-26	2018-09-25
CONTROLLER	INNCO	CO200	SHEM047-1	N/A	N/A
ANTENNA MAST	INNCO	MA400-EP	SHEM047-2	N/A	N/A
TURN DEVICE	INNCO	DE 3600-RH	SHEM047-3	N/A	N/A
Double ridged broadband horn ANTENNA	SCHWARZBECK	BBHA9120D	SHEM050-1	2017-01-14	2018-01-13
High-amplifier	SCHWARZBECK	SCU-F0118-G40-BZ4-CS	SHEM050-2	2017-01-14	2018-01-13
Semi/Fully Anechoic	ST	11*6*6M	SHEM078-2	2017-07-22	2018-07-21

Voltage Fluctuations and Flicker					
Equipment	Manufacturer	Model No	Inventory No	Cal Date	Cal Due Date
Harmonic&Flicker analyzer	AMETEK	PACS-1	SHEM024-2	2017-08-22	2018-08-21
AC Power Source 5KVA	AMETEK	5001iX	SHEM025-2	2017-08-22	2018-08-21

Electrostatic Discharge					
Equipment	Manufacturer	Model No	Inventory No	Cal Date	Cal Due Date
Electrostatic Discharge Simulator	TESEQ	NSG 437	SHEM041-1	2017-09-26	2018-09-25

Electrical Fast Transients/Burst at Power Port					
Equipment	Manufacturer	Model No	Inventory No	Cal Date	Cal Due Date
Immunity Test System	EMC PARTNER	TRA3000 F-S-D-V	SHEM163-1	2016-12-29	2017-12-28

Electrical Fast Transients/Burst at Signal Port					
Equipment	Manufacturer	Model No	Inventory No	Cal Date	Cal Due Date
Immunity Test System	EMC PARTNER	TRA3000 F-S-D-V	SHEM163-1	2016-12-29	2017-12-28
Capacitive coupling clamp	EM test	HFK	SHEM026-2	2017-08-12	2018-08-11
Data coupling network 4 line	EM test	CNV 504	SHEM026-3	2017-08-12	2018-08-11

Surge at Power Port					
Equipment	Manufacturer	Model No	Inventory No	Cal Date	Cal Due Date
Immunity Test System	EMC PARTNER	TRA3000 F-S-D-V	SHEM163-1	2016-12-29	2017-12-28

Surge at Signal Port					
Equipment	Manufacturer	Model No	Inventory No	Cal Date	Cal Due Date
Immunity Test System	EMC PARTNER	TRA3000 F-S-D-V	SHEM163-1	2016-12-29	2017-12-28
Data coupling network 4 line	EM test	CNV 504	SHEM026-3	2017-08-12	2018-08-11



SGS-CSTC Standards Technical Services (Shanghai) Co., Ltd.

Report No.: SHEM180400277401

Page: 11 of 108

Voltage Dips and Interruptions					
Equipment	Manufacturer	Model No	Inventory No	Cal Date	Cal Due Date
Immunity Test System	EMC PARTNER	TRA3000 F-S-D-V	SHEM163-1	2016-12-29	2017-12-28

Mains Supply Voltage Variations-Conditioning					
Equipment	Manufacturer	Model No	Inventory No	Cal Date	Cal Due Date
Immunity Test System	EMC PARTNER	TRA3000 F-S-D-V	SHEM163-1	2016-12-29	2017-12-28

Radiated Immunity(80MHz-2.7GHz)					
Equipment	Manufacturer	Model No	Inventory No	Cal Date	Cal Due Date
Signal generator	Rohde & Schwarz	SMJ100A	SHEM141-1	2017-09-26	2018-09-25
Power Meter	Rohde & Schwarz	NRP	SHEM057-1	2016-12-29	2017-12-28
Power meter sensor	Rohde & Schwarz	NRP-Z91	SHEM057-2	2016-12-29	2017-12-28
Antenna	SCHWARZBECK	STLP9128D	SHEM130-1	N/A	N/A
Antenna	SCHWARZBECK	STLP9149	SHEM131-1	N/A	N/A
Amplifier	MILMEGA	80RF1000-250	SHEM132-1	N/A	N/A
Amplifier	MILMEGA	AS0840-55-55	SHEM133-1	N/A	N/A
Power meter sensor	Rohde & Schwarz	NRP-Z22	SHEM136-1	2017-07-22	2018-07-21
ElectroMagnetic Field Probe	ETS-Lindgren	HI-6113	SHEM134-1	2017-09-07	2018-09-06
Semi/Fully Anechoic	ST	11*6*6M	SHEM078-2	2017-07-22	2018-07-21

Conducted Immunity at Power Port (150kHz-100MHz)					
Equipment	Manufacturer	Model No	Inventory No	Cal Date	Cal Due Date
Signal generator	Rohde & Schwarz	SMJ100A	SHEM141-1	2017-09-26	2018-09-25
PAMP Conducted RF test system	HAEFFLY	PAMP250	SHEM023-1	2016-12-29	2017-12-28
6dB Attenuator	HUAXIANG	TST-150-761	SHEM151-1	N/A	N/A
CDN impedance and K-factor	LUTHI	L-801 M1	SHEM023-5	2016-12-29	2017-12-28
CDN impedance and K-factor	LUTHI	L-801 M2/M3	SHEM023-6	2016-12-29	2017-12-28
Shielding Room	ZHONGYU	5*5*3M	SHEM079-6	2016-12-29	2017-12-28



SGS-CSTC Standards Technical Services (Shanghai) Co., Ltd.

Report No.: SHEM180400277401

Page: 12 of 108

Conducted Immunity at Signal Port (150kHz-100MHz)					
Equipment	Manufacturer	Model No	Inventory No	Cal Date	Cal Due Date
Signal generator	Rohde & Schwarz	SMJ100A	SHEM141-1	2017-09-26	2018-09-25
PAMP Conducted RF test system	HAEFFLY	PAMP250	SHEM023-1	2016-12-29	2017-12-28
6dB Attenuator	HUAXIANG	TST-150-761	SHEM151-1	N/A	N/A
Coupling clamp	LIITHI	EM 101	SHEM027-1	2015-05-03	2018-05-02
CDN impedance and K-factor	LUTHI	L-801 M1	SHEM023-5	2016-12-29	2017-12-28
CDN impedance and K-factor	LUTHI	L-801 M2/M3	SHEM023-6	2016-12-29	2017-12-28

General used equipment					
Equipment	Manufacturer	Model No	Inventory No	Cal Date	Cal Due Date
Digital pressure meter	YONGZHI	DYM3-01	SHEM082-1	2017-03-03	2018-03-02
Temperature&humidity recorder	ShangHai weather meter work	ZJ 1-2B	SHEM042-1~6	2017-09-13	2018-09-12
Digital Multimeter	FLUKE	17B	SHEM043-5	2017-09-13	2018-09-12
Autoformer regulator	Guangzhou bao de	TDGC2-5KVA	SHEM150-1	N/A	N/A
Multi-purpose tong tester	FLUKE	316	SHEM001-1	2017-01-29	2018-01-28

For new model

Conducted Emissions at Mains Terminals (150kHz-30MHz)					
Equipment	Manufacturer	Model No	Inventory No	Cal Date	Cal Due Date
EMI test receiver	Rohde & Schwarz	ESR7	SHEM162-1	2017-12-20	2018-12-19
Line impedance stabilization network	SCHWARZBECK	NSLK8127	SHEM061-1	2017-12-20	2018-12-19
Line impedance stabilization network	EMCO	3816/2	SHEM019-1	2017-12-20	2018-12-19
Pulse limiter	Rohde & Schwarz	ESH3-Z2	SHEM029-1	2017-12-20	2018-12-19
Shielding Room	ZHONGYU	8*4*3M	SHEM079-2	2017-12-20	2020-12-19
CE test Cable	/	/	CE01	2017-12-26	2018-12-25

Asymmetric Mode Conducted Emissions (150kHz-30MHz)					
Equipment	Manufacturer	Model No	Inventory No	Cal Date	Cal Due Date
EMI test receiver	Rohde & Schwarz	ESR7	SHEM162-1	2017-12-20	2018-12-19
Line impedance stabilization network	SCHWARZBECK	NSLK8127	SHEM061-1	2017-12-20	2018-12-19
8-wire ISN cat 5	SCHWARZBECK	CAT5 8158	SHEM137-1	2017-12-20	2018-12-19
8-wire ISN cat 3	SCHWARZBECK	CAT3 8158	SHEM137-2	2017-12-20	2018-12-19
8-wire ISNcat 6	SCHWARZBECK	NTFM8158	SHEM137-3	2017-12-26	2018-12-25
2-Draht ISN	Schwarzbeck - Mess-Elektronik	NTFM 8131	SHEM139-1	2017-12-20	2018-12-19
CE test Cable	/	/	CE01	2017-12-26	2018-12-25



SGS-CSTC Standards Technical Services (Shanghai) Co., Ltd.

Report No.: SHEM180400277401

Page: 13 of 108

Radiated Emissions (30MHz-1GHz)					
Equipment	Manufacturer	Model No	Inventory No	Cal Date	Cal Due Date
EMI test receiver	Rohde & Schwarz	ESU40	SHEM051-1	2017-09-26	2018-09-25
CONTROLLER	INNCO	CO200	SHEM047-1	N/A	N/A
ANTENNA MAST	INNCO	MA400-EP	SHEM047-2	N/A	N/A
TURN DEVICE	INNCO	DE 3600-RH	SHEM047-3	N/A	N/A
Broadband UHF-VHF ANTENNA	SCHWARZBECK	VULB9168	SHEM048-1	2017-02-28	2020-02-27
Semi/Fully Anechoic	ST	11*6*6M	SHEM078-2	2017-07-22	2020-07-21
Low Amplifier	CLAVIIO	BDLNA-0001-412010	SHEM164-1	2017-08-22	2018-08-21

Radiated Emissions (above 1GHz)					
Equipment	Manufacturer	Model No	Inventory No	Cal Date	Cal Due Date
EMI test receiver	Rohde & Schwarz	ESU40	SHEM051-1	2017-09-26	2018-09-25
CONTROLLER	INNCO	CO200	SHEM047-1	N/A	N/A
ANTENNA MAST	INNCO	MA400-EP	SHEM047-2	N/A	N/A
TURN DEVICE	INNCO	DE 3600-RH	SHEM047-3	N/A	N/A
Double ridged broadband horn ANTENNA	SCHWARZBECK	BBHA9120D	SHEM050-1	2017-01-14	2020-01-13
High-amplifier	SCHWARZBECK	SCU-F0118-G40-BZ4-CS	SHEM050-2	2017-12-20	2018-12-19
Semi/Fully Anechoic	ST	11*6*6M	SHEM078-2	2017-07-22	2020-07-21

Harmonic&Voltage Fluctuations and Flicker					
Equipment	Manufacturer	Model No	Inventory No	Cal Date	Cal Due Date
Harmonic&Flicker analyzer	AMETEK	PACS-1	SHEM024-2	2017-08-22	2018-08-21
AC Power Source 5KVA	AMETEK	5001iX	SHEM025-2	2017-08-22	2018-08-21

Electrostatic Discharge					
Equipment	Manufacturer	Model No	Inventory No	Cal Date	Cal Due Date
Electrostatic Discharge Simulator	TESEQ	NSG 437	SHEM041-1	2017-09-26	2018-09-25

Electrical Fast Transients/Burst at Power Port					
Equipment	Manufacturer	Model No	Inventory No	Cal Date	Cal Due Date
Immunity Test System	EMC PARTNER	TRA3000 F-S-D-V	SHEM163-1	2017-12-20	2018-12-19

Electrical Fast Transients/Burst at Signal Port					
Equipment	Manufacturer	Model No	Inventory No	Cal Date	Cal Due Date
Immunity Test System	EMC PARTNER	TRA3000 F-S-D-V	SHEM163-1	2017-12-20	2018-12-19
Capacitive coupling clamp	EM test	HFK	SHEM026-2	2017-12-20	2018-12-19
Data coupling network 4 line	EM test	CNV 504	SHEM026-3	2017-12-20	2018-12-19



SGS-CSTC Standards Technical Services (Shanghai) Co., Ltd.

Report No.: SHEM180400277401

Page: 14 of 108

Surge at Power Port					
Equipment	Manufacturer	Model No	Inventory No	Cal Date	Cal Due Date
Immunity Test System	EMC PARTNER	TRA3000 F-S-D-V	SHEM163-1	2017-12-20	2018-12-19

Surge at Signal Port					
Equipment	Manufacturer	Model No	Inventory No	Cal Date	Cal Due Date
Immunity Test System	EMC PARTNER	TRA3000 F-S-D-V	SHEM163-1	2017-12-20	2018-12-19
Data coupling network 4 line	EM test	CNV 504	SHEM026-3	2017-12-20	2018-12-19

Voltage Dips and Interruptions					
Equipment	Manufacturer	Model No	Inventory No	Cal Date	Cal Due Date
Immunity Test System	EMC PARTNER	TRA3000 F-S-D-V	SHEM163-1	2017-12-20	2018-12-19

Mains Supply Voltage Variations-Conditioning					
Equipment	Manufacturer	Model No	Inventory No	Cal Date	Cal Due Date
Immunity Test System	EMC PARTNER	TRA3000 F-S-D-V	SHEM163-1	2017-12-20	2018-12-19

Radiated Immunity(80MHz-2.7GHz)					
Equipment	Manufacturer	Model No	Inventory No	Cal Date	Cal Due Date
Signal generator	Rohde & Schwarz	SMJ100A	SHEM141-1	2017-09-26	2018-09-25
Power Meter	Rohde & Schwarz	NRP	SHEM057-1	2017-12-20	2018-12-19
Power meter sensor	Rohde & Schwarz	NRP-Z91	SHEM057-2	2017-12-20	2018-12-19
Antenna	SCHWARZBECK	STLP9128D	SHEM130-1	N/A	N/A
Antenna	SCHWARZBECK	STLP9149	SHEM131-1	N/A	N/A
Amplifier	MILMEGA	80RF1000-250	SHEM132-1	N/A	N/A
Amplifier	MILMEGA	AS0840-55-55	SHEM133-1	N/A	N/A
Power meter sensor	Rohde & Schwarz	NRP-Z22	SHEM136-1	2017-12-19	2018-12-18
ElectroMagnetic Field Probe	ETS-Lindgren	HI-6113	SHEM134-1	2017-12-19	2018-12-18
Semi/Fully Anechoic	ST	11*6*6M	SHEM078-2	2017-07-22	2020-07-21

Conducted Immunity at Power Port (150kHz-100MHz)					
Equipment	Manufacturer	Model No	Inventory No	Cal Date	Cal Due Date
Signal generator	Rohde & Schwarz	SMJ100A	SHEM141-1	2017-09-26	2018-09-25
PAMP Conducted RF test system	HAEFFLY	PAMP250	SHEM023-1	2017-12-20	2018-12-19
6dB Attenuator	HUAXIANG	DTS50-6dB-1G-A	SHEM123-2	2017-12-25	2018-12-24
CDN impedance and K-factor	LUTHI	L-801 M1	SHEM023-5	2017-12-20	2018-12-19
CDN impedance and K-factor	LUTHI	L-801 M2/M3	SHEM023-6	2017-12-20	2018-12-19
Shielding Room	ZHONGYU	5*5*3M	SHEM079-6	2016-12-29	2019-12-28



SGS-CSTC Standards Technical Services (Shanghai) Co., Ltd.

Report No.: SHEM180400277401

Page: 15 of 108

Conducted Immunity at Signal Port (150kHz-100MHz)					
Equipment	Manufacturer	Model No	Inventory No	Cal Date	Cal Due Date
Signal generator	Rohde & Schwarz	SMJ100A	SHEM141-1	2017-09-26	2018-09-25
PAMP Conducted RF test system	HAEFFLY	PAMP250	SHEM023-1	2017-12-20	2018-12-19
6dB Attenuator	HUAXIANG	DTS50-6dB-1G-A	SHEM123-2	2017-12-25	2018-12-24
Coupling clamp	LIITHI	EM 101	SHEM027-1	2017-12-20	2018-12-19
CDN impedance and K-factor	LUTHI	L-801 M1	SHEM023-5	2017-12-20	2018-12-19
CDN impedance and K-factor	LUTHI	L-801 M2/M3	SHEM023-6	2017-12-20	2018-12-19

General used equipment					
Equipment	Manufacturer	Model No	Inventory No	Cal Date	Cal Due Date
Digital pressure meter	YONGZHI	DYM3-01	SHEM082-1	2018-01-25	2019-01-24
Temperature&humidity recorder	ShangHai weather meter work	ZJ 1-2B	SHEM042-1~6	2017-09-13	2018-09-12
Digital Multimeter	FLUKE	17B	SHEM043-3	2017-09-11	2018-09-10
Autoformer regulator	Guangzhou bao de	TDGC2-5KVA	SHEM150-1	N/A	N/A
Multi-purpose tong tester	FLUKE	316	SHEM001-1	2017-12-20	2018-12-19

6 Emission Test Results

6.1 Conducted Emissions at Mains Terminals (150kHz-30MHz)

Test Requirement:	EN 55032:2015
Test Method:	EN 55032:2015
Frequency Range:	150kHz to 30MHz
Limit:	
0.15M-0.5MHz	66dB(μV)-56dB(μV) quasi-peak, 56dB(μV)-46dB(μV) average
0.5M-5MHz	56dB(μV) quasi-peak, 46dB(μV) average
5M-30MHz	60dB(μV) quasi-peak, 50dB(μV) average
Detector:	Peak for pre-scan (9kHz resolution bandwidth) 0.15M to 30MHz

6.1.1 E.U.T. Operation

Operating Environment:

Temperature: 22 °C Humidity: 50 % RH Atmospheric Pressure: 1020 mbar

- Test mode:
- a: keep EUT previewing with DC12V support .
 - b: keep EUT previewing with PoE support .
 - c: keep DS-2CD2683G0-I previewing with DC12V support .
 - d: keep DS-2CD2683G0-I previewing with PoE support .
 - e: keep DS-2CD2663G0-I previewing with DC12V support .
 - f: keep DS-2CD2663G0-I previewing with PoE support .

6.1.2 Test Setup Diagram

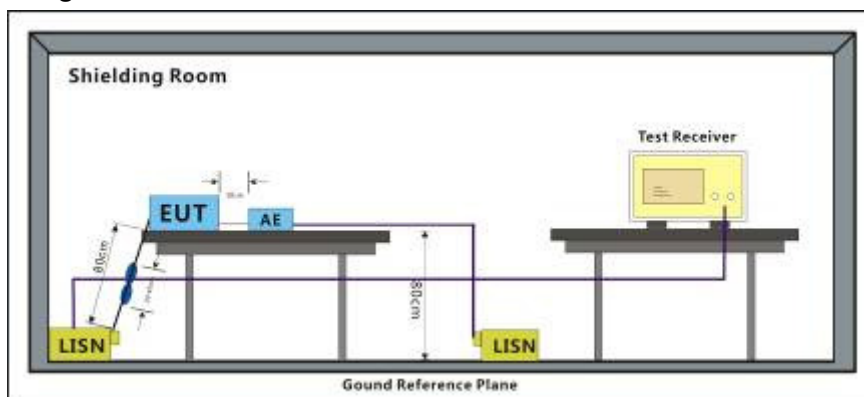

6.1.3 Measurement Data

An initial pre-scan was performed with peak detector. Quasi-Peak or Average measurement were performed at the frequencies with maximized peak emission were detected.

Notes : Emission Level=Read Level + LISN Factor + Cable Loss



SGS-CSTC Standards Technical Services (Shanghai) Co., Ltd.

Report No.: SHEM180400277401
Page: 17 of 108

For old model
Mode:a; Line:Live Line

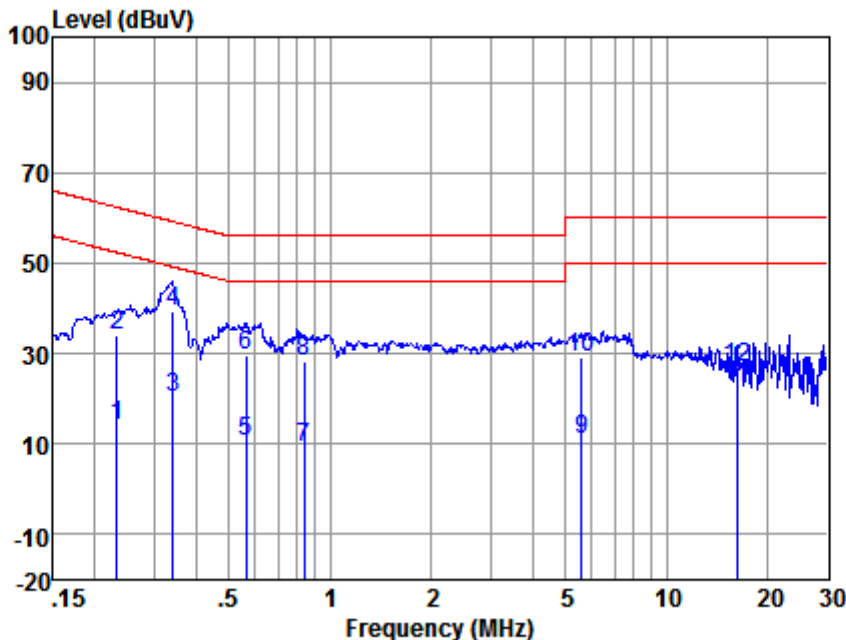

Site : chamber
Condition : LISN-L-2017
EUT/Project No: 8675IT
Test mode : a

	Read Freq	Level	LISN Factor	Cable Loss	Level	Limit Line	Over Limit	Remark
	MHz	dBuV	dB	dB	dBuV	dBuV	dB	
1	0.232	4.09	0.11	9.81	14.01	52.39	-38.38	Average
2	0.232	23.94	0.11	9.81	33.86	62.39	-28.53	QP
3	0.341	10.24	0.11	9.81	20.16	49.18	-29.02	Average
4	0.341	29.52	0.11	9.81	39.44	59.18	-19.74	QP
5	0.561	0.66	0.11	9.82	10.59	46.00	-35.41	Average
6	0.561	19.69	0.11	9.82	29.62	56.00	-26.38	QP
7	0.835	-0.74	0.11	9.83	9.20	46.00	-36.80	Average
8	0.835	18.51	0.11	9.83	28.45	56.00	-27.55	QP
9	5.594	0.87	0.11	9.86	10.84	50.00	-39.16	Average
10	5.594	19.26	0.11	9.86	29.23	60.00	-30.77	QP
11	16.226	12.54	0.16	10.02	22.72	50.00	-27.28	Average
12	16.226	16.75	0.16	10.02	26.93	60.00	-33.07	QP

Mode:a; Line:Neutral Line

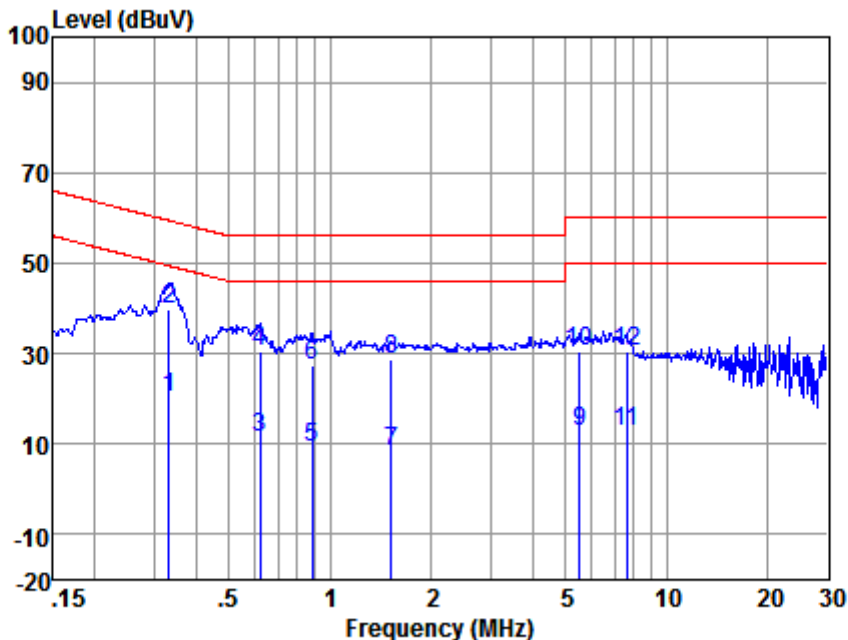

Site : chamber
Condition : LISN-N-2017
EUT/Project No: 8675IT
Test mode : a

	Read	LISN	Cable	Limit	Over		
Freq	Level	Factor	Loss	Line	Limit	Remark	
MHz	dBuV	dB	dB	dBuV	dBuV	dB	
1	0.332	10.54	0.11	9.81	20.46	49.40	-28.94 Average
2	0.332	29.90	0.11	9.81	39.82	59.40	-19.58 QP
3	0.617	1.29	0.11	9.82	11.22	46.00	-34.78 Average
4	0.617	20.43	0.11	9.82	30.36	56.00	-25.64 QP
5	0.885	-0.58	0.11	9.83	9.36	46.00	-36.64 Average
6	0.885	17.53	0.11	9.83	27.47	56.00	-28.53 QP
7	1.519	-1.40	0.12	9.84	8.56	46.00	-37.44 Average
8	1.519	18.86	0.12	9.84	28.82	56.00	-27.18 QP
9	5.505	2.98	0.13	9.86	12.97	50.00	-37.03 Average
10	5.505	20.39	0.13	9.86	30.38	60.00	-29.62 QP
11	7.606	2.86	0.13	9.86	12.85	50.00	-37.15 Average
12	7.606	20.48	0.13	9.86	30.47	60.00	-29.53 QP

Mode:b; Line:Live Line

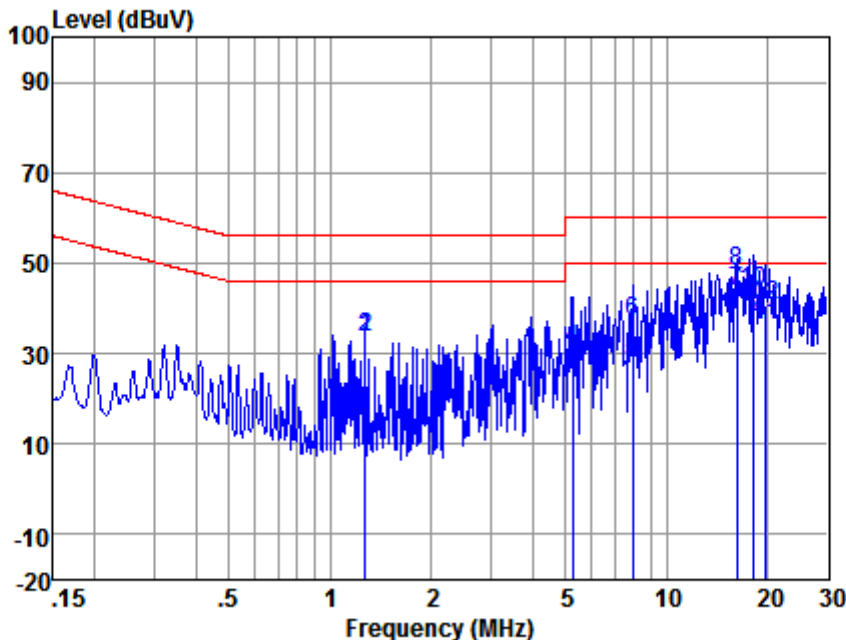

Site : chamber
Condition : LISN-L-2017
EUT/Project No: 8675IT
Test mode : b

	Freq	Read Level	LISN Factor	Cable Loss	Level	Limit Line	Over Limit	Remark
	MHz	dBuV	dB	dB	dBuV	dBuV	dB	
1	1.269	23.46	0.11	9.84	33.41	46.00	-12.59	Average
2	1.269	23.81	0.11	9.84	33.76	56.00	-22.24	QP
3	5.249	15.03	0.11	9.86	25.00	50.00	-25.00	Average
4	5.249	21.00	0.11	9.86	30.97	60.00	-29.03	QP
5	7.935	18.41	0.10	9.86	28.37	50.00	-21.63	Average
6	7.935	27.27	0.10	9.86	37.23	60.00	-22.77	QP
7	16.226	33.37	0.16	10.02	43.55	50.00	-6.45	Average
8	16.226	37.79	0.16	10.02	47.97	60.00	-12.03	QP
9	18.232	27.81	0.17	10.03	38.01	50.00	-11.99	Average
10	18.232	33.65	0.17	10.03	43.85	60.00	-16.15	QP
11	19.740	25.95	0.18	10.03	36.16	50.00	-13.84	Average
12	19.740	30.48	0.18	10.03	40.69	60.00	-19.31	QP

Mode:b; Line:Neutral Line

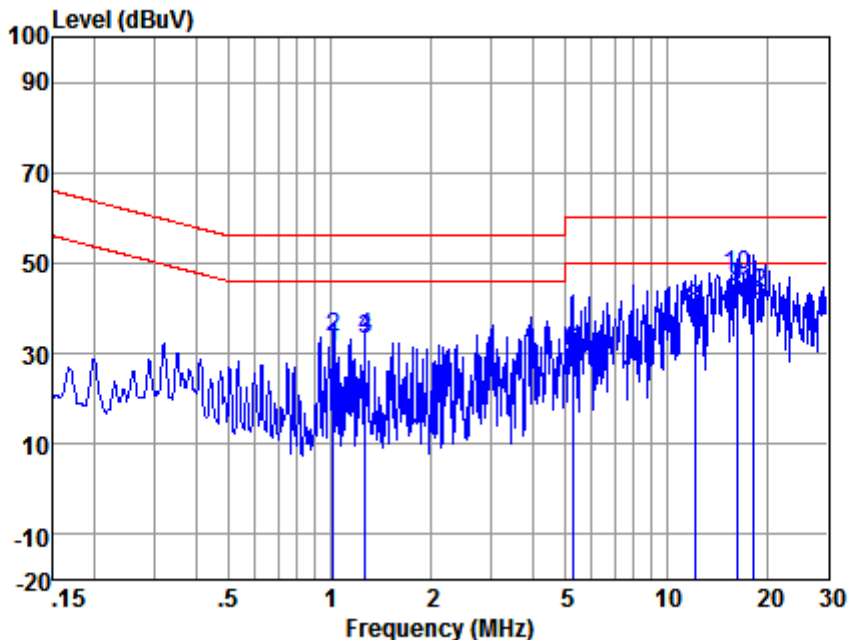

Site : chamber
Condition : LISN-N-2017
EUT/Project No: 8675IT
Test mode : b

	Freq	Read Level	LISN Factor	Cable Loss	Level	Limit Line	Over Limit	Remark
	MHz	dBuV	dB	dB	dBuV	dBuV	dB	
1	1.021	21.27	0.11	9.84	31.22	46.00	-14.78	Average
2	1.021	23.72	0.11	9.84	33.67	56.00	-22.33	QP
3	1.269	23.06	0.11	9.84	33.01	46.00	-12.99	Average
4	1.269	23.81	0.11	9.84	33.76	56.00	-22.24	QP
5	5.249	18.73	0.13	9.86	28.72	50.00	-21.28	Average
6	5.249	20.68	0.13	9.86	30.67	60.00	-29.33	QP
7	12.188	26.51	0.15	9.90	36.56	50.00	-13.44	Average
8	12.188	29.83	0.15	9.90	39.88	60.00	-20.12	QP
9	16.226	34.60	0.18	10.02	44.80	50.00	-5.20	Average
10	16.226	37.05	0.18	10.02	47.25	60.00	-12.75	QP
11	18.232	28.65	0.19	10.03	38.87	50.00	-11.13	Average
12	18.232	33.11	0.19	10.03	43.33	60.00	-16.67	QP

For new model
Mode:c; Line:Live Line

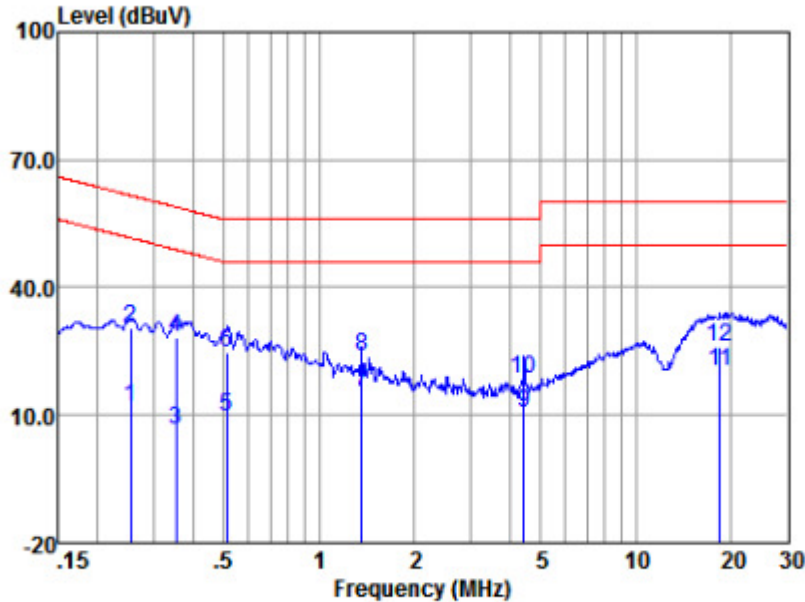

LISN : LINE
EUT/Project No : 2774IT
Test Mode : c

	Freq (MHz)	Read level (dBUV)	LISN Factor (dB)	Cable Loss (dB)	Emission Level (dBUV)	Limit (dBUV)	Over Limit (dB)	Remark
1	0.25	1.85	0.11	9.81	11.77	51.64	-39.87	Average
2	0.25	20.73	0.11	9.81	30.65	61.64	-30.99	QP
3	0.35	-3.20	0.11	9.81	6.72	48.87	-42.15	Average
4	0.35	18.49	0.11	9.81	28.41	58.87	-30.46	QP
5	0.51	-0.30	0.11	9.82	9.63	46.00	-36.37	Average
6	0.51	14.73	0.11	9.82	24.66	56.00	-31.34	QP
7	1.36	5.45	0.11	9.84	15.40	46.00	-30.60	Average
8	1.36	14.04	0.11	9.84	23.99	56.00	-32.01	QP
9	4.43	0.46	0.11	9.86	10.43	46.00	-35.57	Average
10	4.43	8.76	0.11	9.86	18.73	56.00	-37.27	QP
11	18.52	10.26	0.17	10.03	20.46	50.00	-29.54	Average
12	18.52	15.96	0.17	10.03	26.16	60.00	-33.84	QP

Notes: Emission Level = Read Level + LISN Factor + Cable loss

Mode:c; Line:Neutral Line

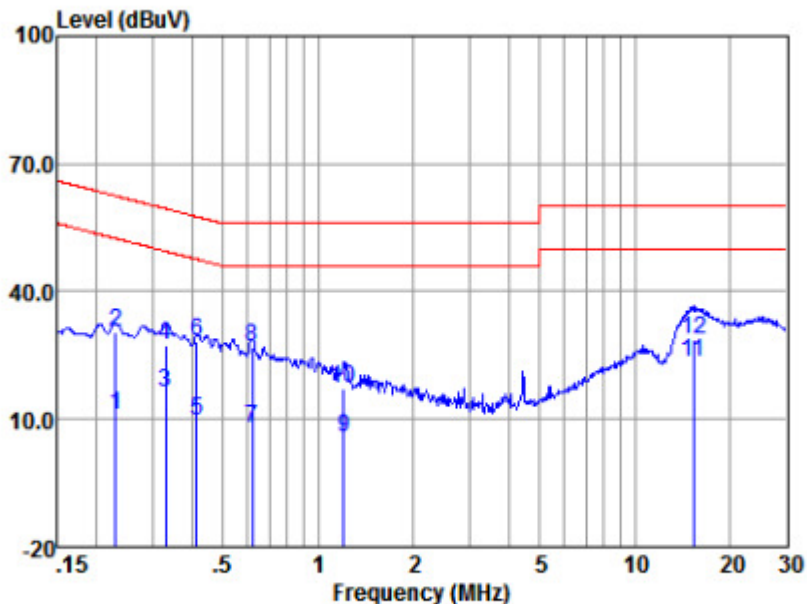

LISN : NEUTRAL
EUT/Project No : 2774IT
Test Mode : c

	Freq (MHz)	Read level (dBUV)	LISN Factor (dB)	Cable Loss (dB)	Emission Level (dBUV)	Limit (dBUV)	Over Limit (dB)	Remark
1	0.23	1.23	0.11	9.81	11.15	52.48	-41.33	Average
2	0.23	20.35	0.11	9.81	30.27	62.48	-32.21	QP
3	0.33	6.49	0.11	9.81	16.41	49.44	-33.03	Average
4	0.33	17.30	0.11	9.81	27.22	59.44	-32.22	QP
5	0.41	-0.37	0.11	9.82	9.56	47.59	-38.03	Average
6	0.41	18.19	0.11	9.82	28.12	57.59	-29.47	QP
7	0.62	-1.94	0.11	9.82	7.99	46.00	-38.01	Average
8	0.62	17.01	0.11	9.82	26.94	56.00	-29.06	QP
9	1.20	-4.41	0.11	9.84	5.54	46.00	-40.46	Average
10	1.20	7.24	0.11	9.84	17.19	56.00	-38.81	QP
11	15.39	13.14	0.17	10.02	23.33	50.00	-26.67	Average
12	15.39	18.56	0.17	10.02	28.75	60.00	-31.25	QP

Notes: Emission Level = Read Level + LISN Factor + Cable loss



SGS-CSTC Standards Technical Services (Shanghai) Co., Ltd.

Report No.: SHEM180400277401
Page: 23 of 108

Mode:d; Line:Live Line

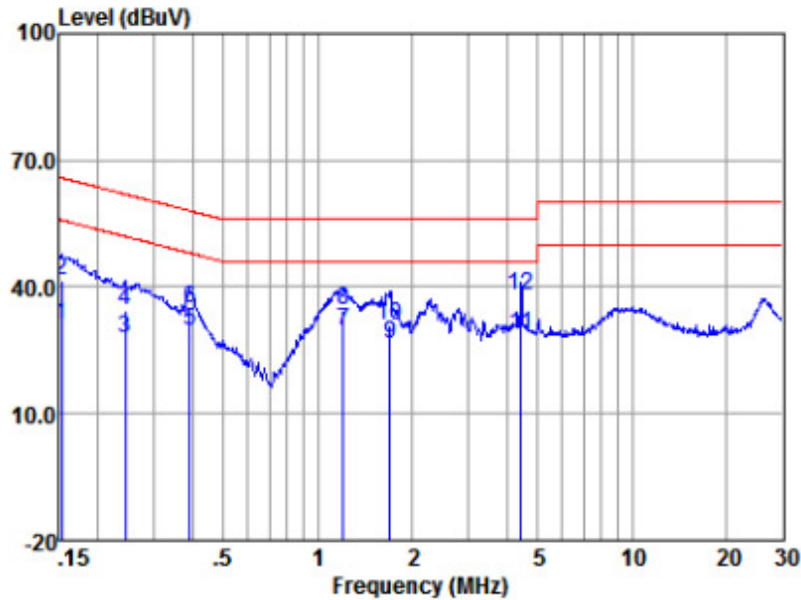

LISN : LINE
EUT/Project No : 2774IT
Test Mode : d

	Freq (MHz)	Read level (dBuV)	LISN Factor (dB)	Cable Loss (dB)	Emission Level (dBuV)	Limit (dBuV)	Over Limit (dB)	Remark
1	0.15	20.92	0.11	9.81	30.84	55.87	-25.03	Average
2	0.15	31.83	0.11	9.81	41.75	65.87	-24.12	QP
3	0.24	17.69	0.11	9.81	27.61	51.95	-24.34	Average
4	0.24	24.44	0.11	9.81	34.36	61.95	-27.59	QP
5	0.39	19.78	0.11	9.81	29.70	48.03	-18.33	Average
6	0.39	24.89	0.11	9.81	34.81	58.03	-23.22	QP
7	1.20	19.79	0.11	9.84	29.74	46.00	-16.26	Average
8	1.20	24.61	0.11	9.84	34.56	56.00	-21.44	QP
9	1.70	16.50	0.11	9.84	26.45	46.00	-19.55	Average
10	1.70	20.96	0.11	9.84	30.91	56.00	-25.09	QP
11	4.43	18.55	0.11	9.86	28.52	46.00	-17.48	Average
12	4.43	28.06	0.11	9.86	38.03	56.00	-17.97	QP

Notes: Emission Level = Read Level + LISN Factor + Cable loss

Mode:d; Line:Neutral Line

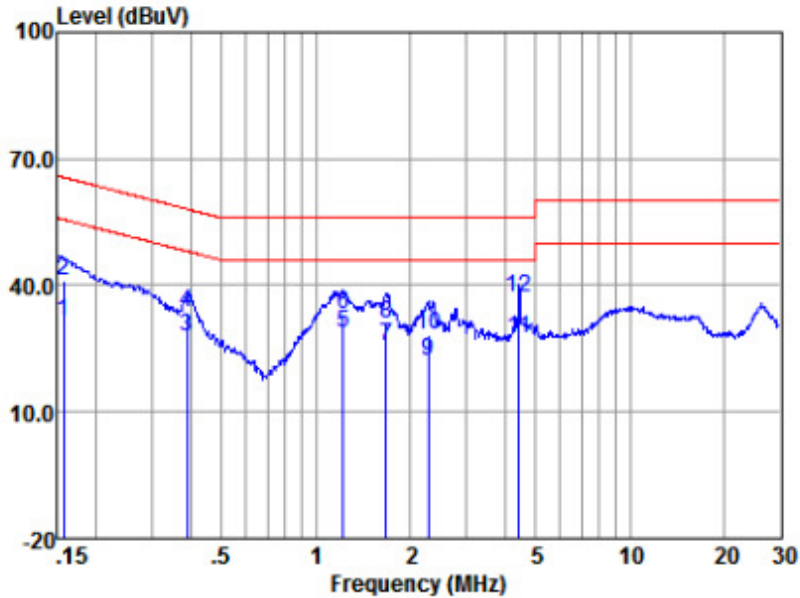

LISN : NEUTRAL
EUT/Project No : 2774IT
Test Mode : d

	Freq (MHz)	Read level (dBuV)	LISN Factor (dB)	Cable Loss (dB)	Emission Level (dBuV)	Limit (dBuV)	Over Limit (dB)	Remark
1	0.16	21.23	0.12	9.81	31.16	55.60	-24.44	Average
2	0.16	31.04	0.12	9.81	40.97	65.60	-24.63	QP
3	0.39	17.91	0.11	9.81	27.83	48.08	-20.25	Average
4	0.39	23.48	0.11	9.81	33.40	58.08	-24.68	QP
5	1.22	18.84	0.11	9.84	28.79	46.00	-17.21	Average
6	1.22	23.37	0.11	9.84	33.32	56.00	-22.68	QP
7	1.67	15.84	0.12	9.84	25.80	46.00	-20.20	Average
8	1.67	20.88	0.12	9.84	30.84	56.00	-25.16	QP
9	2.27	11.88	0.12	9.85	21.85	46.00	-24.15	Average
10	2.27	18.15	0.12	9.85	28.12	56.00	-27.88	QP
11	4.43	17.51	0.13	9.86	27.50	46.00	-18.50	Average
12	4.43	27.02	0.13	9.86	37.01	56.00	-18.99	QP

Notes: Emission Level = Read Level + LISN Factor + Cable loss

Mode:e; Line:Live Line

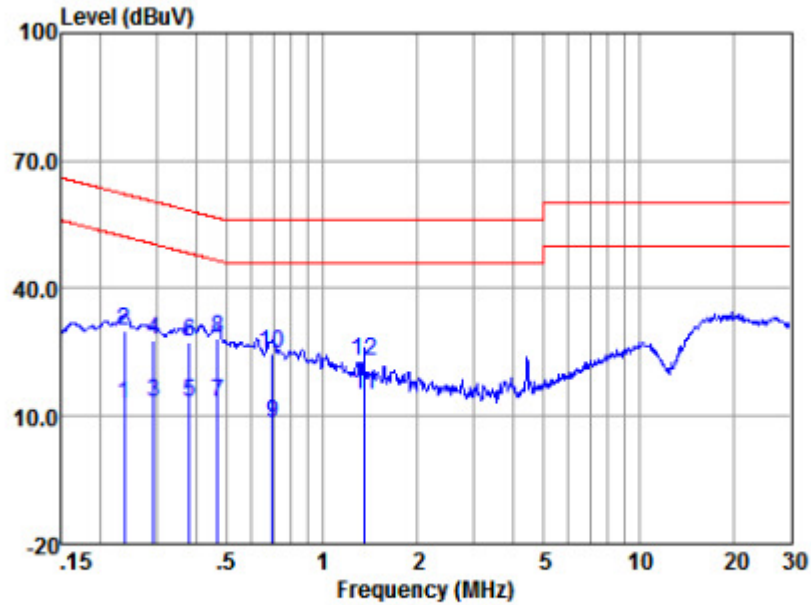

LISN : LINE
EUT/Project No : 2774IT
Test Mode : e

	Freq (MHz)	Read level (dBuV)	LISN Factor (dB)	Cable Loss (dB)	Emission Level (dBuV)	Limit (dBuV)	Over Limit (dB)	Remark
1	0.24	2.84	0.11	9.81	12.76	52.17	-39.41	Average
2	0.24	19.96	0.11	9.81	29.88	62.17	-32.29	QP
3	0.29	3.35	0.11	9.81	13.27	50.41	-37.14	Average
4	0.29	18.02	0.11	9.81	27.94	60.41	-32.47	QP
5	0.38	3.13	0.11	9.81	13.05	48.25	-35.20	Average
6	0.38	17.37	0.11	9.81	27.29	58.25	-30.96	QP
7	0.47	3.48	0.11	9.82	13.41	46.54	-33.13	Average
8	0.47	18.18	0.11	9.82	28.11	56.54	-28.43	QP
9	0.69	-1.67	0.11	9.83	8.27	46.00	-37.73	Average
10	0.69	14.86	0.11	9.83	24.80	56.00	-31.20	QP
11	1.36	5.19	0.11	9.84	15.14	46.00	-30.86	Average
12	1.36	12.92	0.11	9.84	22.87	56.00	-33.13	QP

Notes: Emission Level = Read Level + LISN Factor + Cable loss



Mode:e; Line:Neutral Line

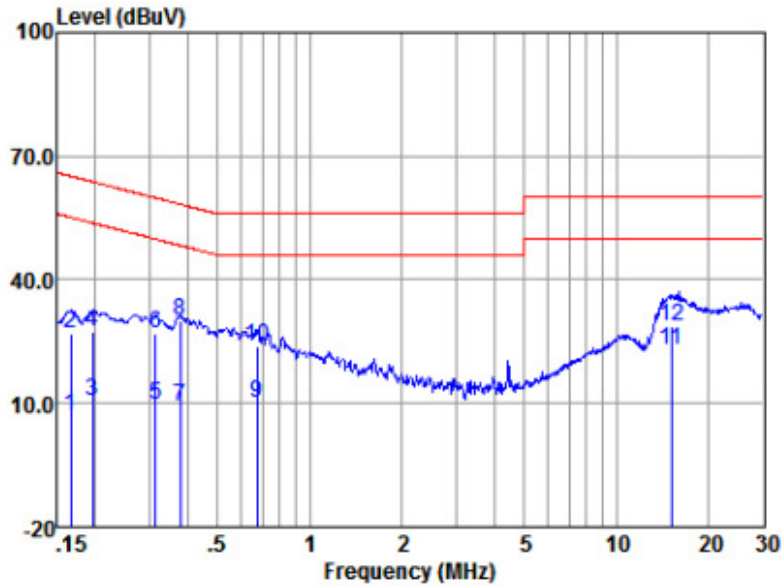

LISN : NEUTRAL
EUT/Project No : 2774IT
Test Mode : e

	Freq (MHz)	Read level (dBuV)	LISN Factor (dB)	Cable Loss (dB)	Emission Level (dBuV)	Limit (dBuV)	Over Limit (dB)	Remark
1	0.17	-2.88	0.12	9.81	7.05	55.16	-48.11	Average
2	0.17	17.14	0.12	9.81	27.07	65.16	-38.09	QP
3	0.20	0.55	0.12	9.81	10.48	53.80	-43.32	Average
4	0.20	17.57	0.12	9.81	27.50	63.80	-36.30	QP
5	0.31	-0.36	0.11	9.81	9.56	49.84	-40.28	Average
6	0.31	16.91	0.11	9.81	26.83	59.84	-33.01	QP
7	0.38	-0.52	0.11	9.81	9.40	48.30	-38.90	Average
8	0.38	20.07	0.11	9.81	29.99	58.30	-28.31	QP
9	0.67	0.12	0.11	9.83	10.06	46.00	-35.94	Average
10	0.67	14.07	0.11	9.83	24.01	56.00	-31.99	QP
11	15.15	12.91	0.17	10.02	23.10	50.00	-26.90	Average
12	15.15	18.53	0.17	10.02	28.72	60.00	-31.28	QP

Notes: Emission Level = Read Level + LISN Factor + Cable loss

Mode:f; Line:Live Line

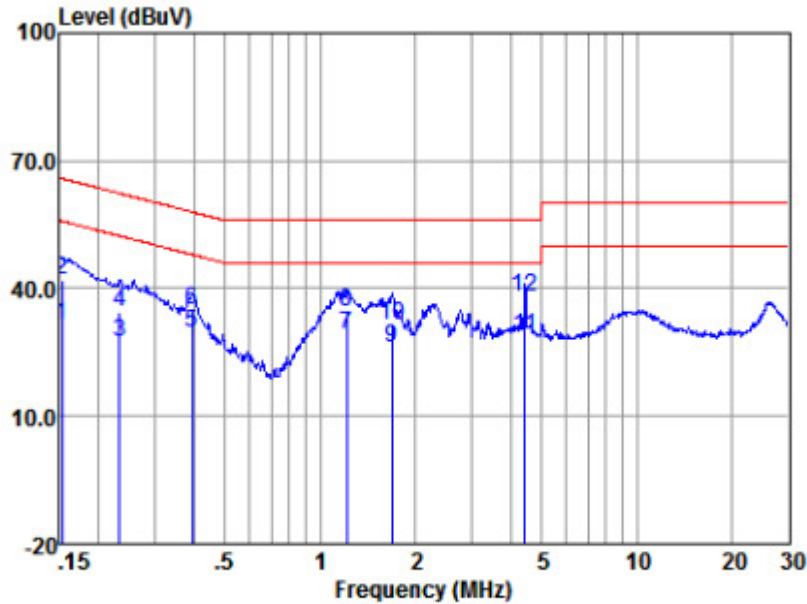

LISN : LINE
EUT/Project No : 2774IT
Test Mode : f

	Freq (MHz)	Read level (dBuV)	LISN Factor (dB)	Cable Loss (dB)	Emission Level (dBuV)	Limit (dBuV)	Over Limit (dB)	Remark
1	0.15	21.28	0.11	9.81	31.20	55.87	-24.67	Average
2	0.15	31.91	0.11	9.81	41.83	65.87	-24.04	QP
3	0.23	17.43	0.11	9.81	27.35	52.35	-25.00	Average
4	0.23	24.64	0.11	9.81	34.56	62.35	-27.79	QP
5	0.39	19.62	0.11	9.81	29.54	47.99	-18.45	Average
6	0.39	24.86	0.11	9.81	34.78	57.99	-23.21	QP
7	1.21	19.10	0.11	9.84	29.05	46.00	-16.95	Average
8	1.21	24.35	0.11	9.84	34.30	56.00	-21.70	QP
9	1.69	16.19	0.11	9.84	26.14	46.00	-19.86	Average
10	1.69	21.21	0.11	9.84	31.16	56.00	-24.84	QP
11	4.43	18.52	0.11	9.86	28.49	46.00	-17.51	Average
12	4.43	27.93	0.11	9.86	37.90	56.00	-18.10	QP

Notes: Emission Level = Read Level + LISN Factor + Cable loss



SGS-CSTC Standards Technical Services (Shanghai) Co., Ltd.

Report No.: SHEM180400277401
Page: 28 of 108

Mode:f; Line:Neutral Line

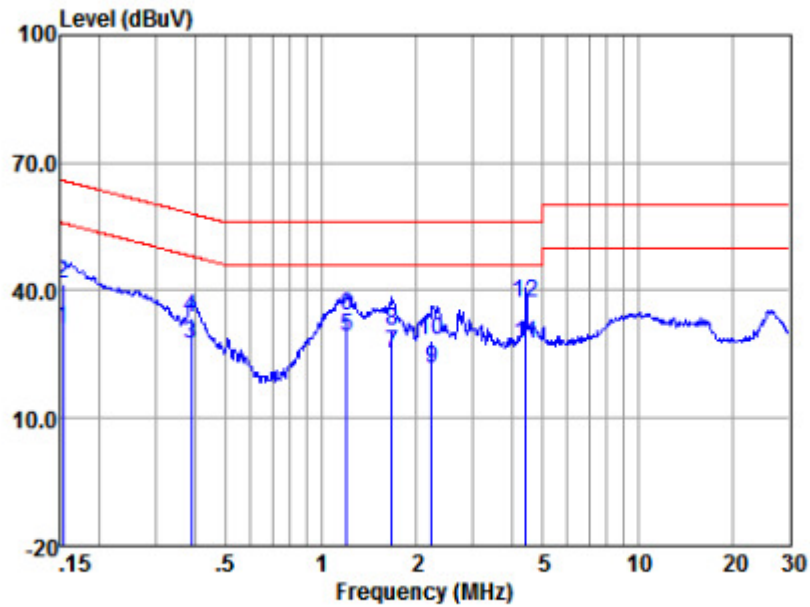

LISN : NEUTRAL
EUT/Project No : 2774IT
Test Mode : f

	Freq (MHz)	Read level (dBuV)	LISN Factor (dB)	Cable Loss (dB)	Emission Level (dBuV)	Limit (dBuV)	Over Limit (dB)	Remark
1	0.15	21.06	0.12	9.81	30.99	55.87	-24.88	Average
2	0.15	31.45	0.12	9.81	41.38	65.87	-24.49	QP
3	0.39	17.68	0.11	9.81	27.60	48.08	-20.48	Average
4	0.39	23.49	0.11	9.81	33.41	58.08	-24.67	QP
5	1.20	19.27	0.11	9.84	29.22	46.00	-16.78	Average
6	1.20	23.93	0.11	9.84	33.88	56.00	-22.12	QP
7	1.67	15.27	0.12	9.84	25.23	46.00	-20.77	Average
8	1.67	20.71	0.12	9.84	30.67	56.00	-25.33	QP
9	2.24	11.50	0.12	9.85	21.47	46.00	-24.53	Average
10	2.24	18.27	0.12	9.85	28.24	56.00	-27.76	QP
11	4.43	17.53	0.13	9.86	27.52	46.00	-18.48	Average
12	4.43	26.91	0.13	9.86	36.90	56.00	-19.10	QP

Notes: Emission Level = Read Level + LISN Factor + Cable loss

6.2 Asymmetric Mode Conducted Emissions (150kHz-30MHz)

Test Requirement:	EN 55032:2015
Test Method:	EN 55032:2015
Frequency Range:	150kHz to 30MHz
Limit:	
0.15M-0.5MHz(Voltage)	84-74(dBμV) quasi-peak; 74-64(dBμV) average
0.5M-30MHz(Voltage)	74(dBμV) quasi-peak; 64(dBμV) average
0.15M-0.5MHz(Current)	40-30(dBμV) quasi-peak; 30-20(dBμV) average
0.5M-30MHz(Current)	30(dBμV) quasi-peak; 20(dBμV) average
Detector:	9kHz resolution bandwidth 0.15M to 30MHz

6.2.1 E.U.T. Operation

Operating Environment:

Temperature: 22 °C Humidity: 50 % RH Atmospheric Pressure: 1020 mbar

- Test mode:
- a: keep EUT previewing with DC12V support .
 - b: keep EUT previewing with PoE support .
 - c: keep DS-2CD2683G0-I previewing with DC12V support .
 - d: keep DS-2CD2683G0-I previewing with PoE support .
 - e: keep DS-2CD2663G0-I previewing with DC12V support .
 - f: keep DS-2CD2663G0-I previewing with PoE support .

6.2.2 Test Setup Diagram

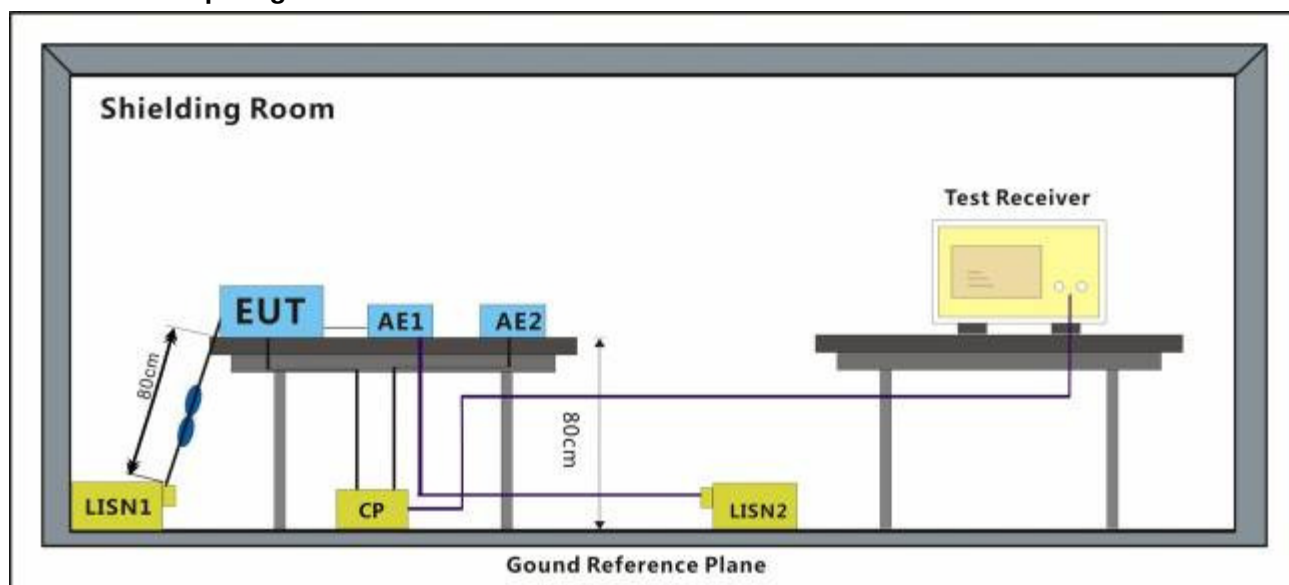

6.2.3 Measurement Data

Notes : Emission Level=Read Level + LISN Factor + Cable Loss



SGS-CSTC Standards Technical Services (Shanghai) Co., Ltd.

Report No.: SHEM180400277401
Page: 30 of 108

For old model
Mode:a

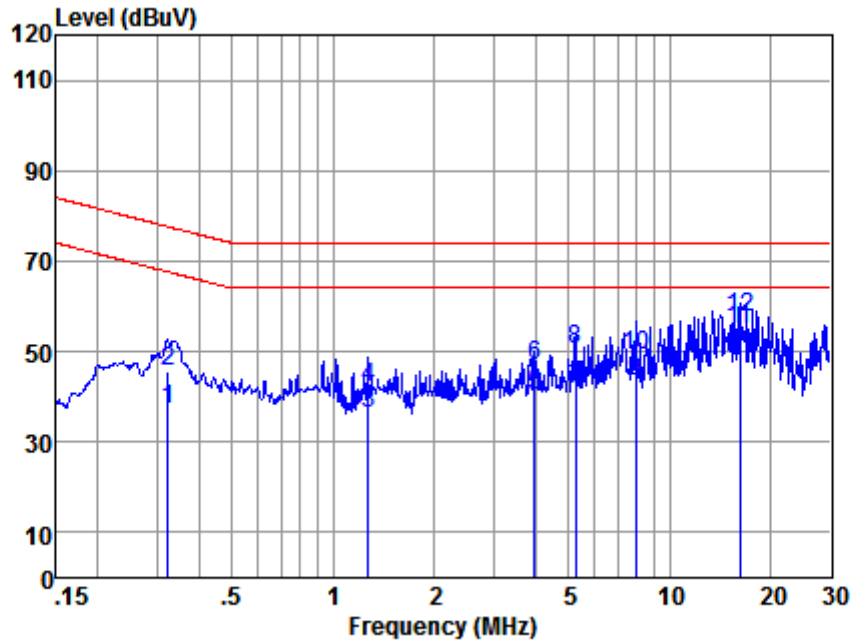

Site : chamber
Condition : ISN CAT5
EUT/Project No: 8675IT
Test mode : a

	Freq	Read Level	LISN Factor	Cable Loss	Level	Limit Line	Over Limit	Remark
	MHz	dBuV	dB	dB	dBuV	dBuV	dB	
1	0.323	17.92	9.53	9.81	37.26	67.62	-30.36	Average
2	0.323	26.33	9.53	9.81	45.67	77.62	-31.95	QP
3	1.269	17.04	9.32	9.84	36.20	64.00	-27.80	Average
4	1.269	23.08	9.32	9.84	42.24	74.00	-31.76	QP
5	3.964	21.23	9.22	9.85	40.30	64.00	-23.70	Average
6	3.964	27.87	9.22	9.85	46.94	74.00	-27.06	QP
7	5.249	22.46	9.20	9.86	41.52	64.00	-22.48	Average
8	5.249	31.49	9.20	9.86	50.55	74.00	-23.45	QP
9	7.935	24.38	9.20	9.86	43.44	64.00	-20.56	Average
10	7.935	30.25	9.20	9.86	49.31	74.00	-24.69	QP
11	16.226	35.80	9.25	10.02	55.07	64.00	-8.93	Average
12	16.226	38.41	9.25	10.02	57.68	74.00	-16.32	QP

Mode:b

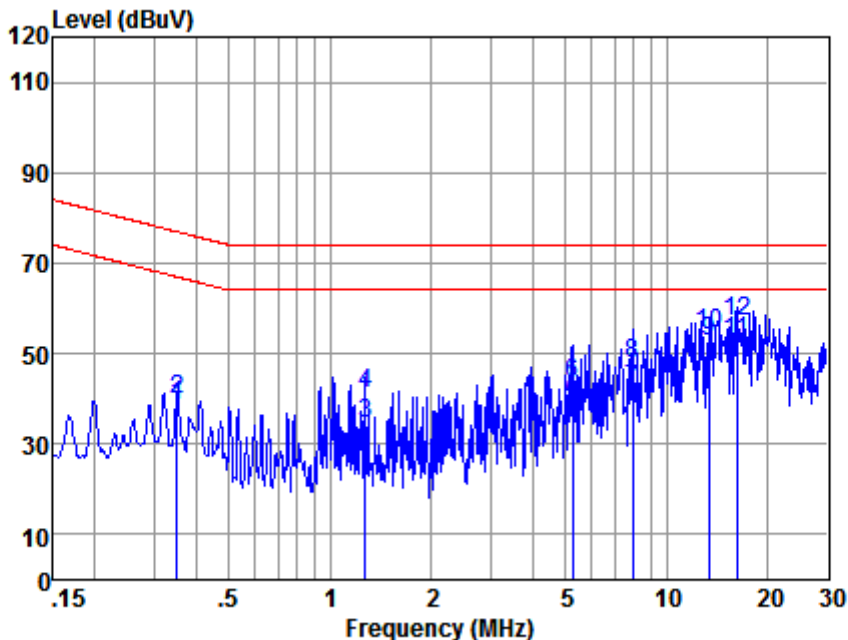

Site : chamber
Condition : ISN CAT5
EUT/Project No: 8675IT
Test mode : b

	Freq	Read Level	LISN Factor	Cable Loss	Level	Limit Line	Over Limit	Remark
	MHz	dBuV	dB	dB	dBuV	dBuV	dB	
1	0.350	19.30	9.52	9.81	38.63	66.96	-28.33	Average
2	0.350	20.49	9.52	9.81	39.82	76.96	-37.14	QP
3	1.269	15.58	9.32	9.84	34.74	64.00	-29.26	Average
4	1.269	21.83	9.32	9.84	40.99	74.00	-33.01	QP
5	5.249	19.68	9.20	9.86	38.74	64.00	-25.26	Average
6	5.249	24.50	9.20	9.86	43.56	74.00	-30.44	QP
7	7.935	22.90	9.20	9.86	41.96	64.00	-22.04	Average
8	7.935	28.57	9.20	9.86	47.63	74.00	-26.37	QP
9	13.337	33.60	9.23	9.96	52.79	64.00	-11.21	Average
10	13.337	35.34	9.23	9.96	54.53	74.00	-19.47	QP
11	16.226	33.58	9.25	10.02	52.85	64.00	-11.15	Average
12	16.226	37.73	9.25	10.02	57.00	74.00	-17.00	QP



SGS-CSTC Standards Technical Services (Shanghai) Co., Ltd.

Report No.: SHEM180400277401
Page: 32 of 108

For new model
Mode:c;

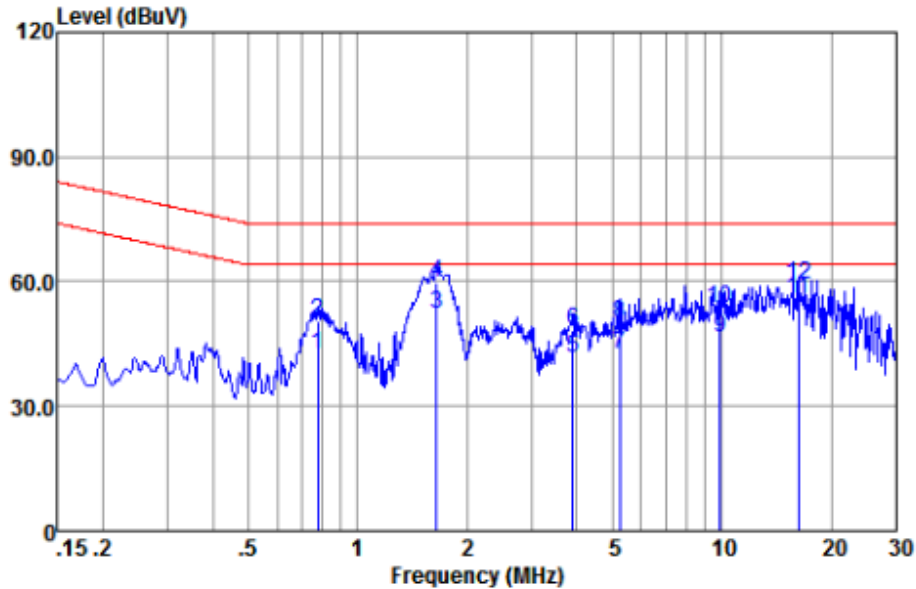

ISN : ISN CAT5
EUT/Project No : 2774IT
Test Mode : c

	Freq (MHz)	Read level (dBuV)	ISN Factor (dB)	Cable Loss (dB)	Emission Level (dBuV)	Limit (dBuV)	Over Limit (dB)	Remark
1	0.78	23.37	9.38	9.83	42.58	64.00	-21.42	Average
2	0.78	31.23	9.38	9.83	50.44	74.00	-23.56	QP
3	1.64	33.08	9.29	9.84	52.21	64.00	-11.79	Average
4	1.64	40.49	9.29	9.84	59.62	74.00	-14.38	QP
5	3.90	22.33	9.22	9.85	41.40	64.00	-22.60	Average
6	3.90	29.16	9.22	9.85	48.23	74.00	-25.77	QP
7	5.25	23.35	9.20	9.86	42.41	64.00	-21.59	Average
8	5.25	31.12	9.20	9.86	50.18	74.00	-23.82	QP
9	9.91	27.21	9.20	9.87	46.28	64.00	-17.72	Average
10	9.91	34.71	9.20	9.87	53.78	74.00	-20.22	QP
11	16.23	36.30	9.25	10.02	55.57	64.00	-8.43	Average
12	16.23	39.96	9.25	10.02	59.23	74.00	-14.77	QP

Notes: Emission Level = Read Level + ISN Factor + Cable loss

Mode:d;

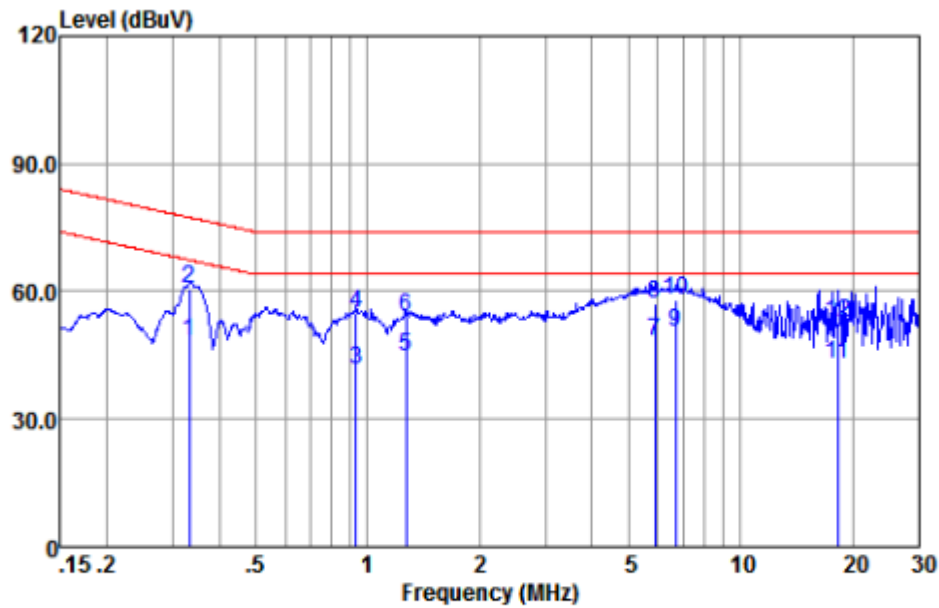

ISN : ISN CAT5
EUT/Project No : 2774IT
Test Mode : d

	Freq (MHz)	Read level (dBuV)	ISN Factor (dB)	Cable Loss (dB)	Emission Level (dBuV)	Limit (dBuV)	Over Limit (dB)	Remark
1	0.33	29.09	9.53	9.81	48.43	67.40	-18.97	Average
2	0.33	41.23	9.53	9.81	60.57	77.40	-16.83	QP
3	0.93	22.60	9.36	9.83	41.79	64.00	-22.21	Average
4	0.93	35.59	9.36	9.83	54.78	74.00	-19.22	QP
5	1.27	25.55	9.32	9.84	44.71	64.00	-19.29	Average
6	1.27	34.73	9.32	9.84	53.89	74.00	-20.11	QP
7	5.90	29.36	9.20	9.86	48.42	64.00	-15.58	Average
8	5.90	37.96	9.20	9.86	57.02	74.00	-16.98	QP
9	6.70	31.21	9.20	9.86	50.27	64.00	-13.73	Average
10	6.70	38.95	9.20	9.86	58.01	74.00	-15.99	QP
11	18.23	23.72	9.28	10.03	43.03	64.00	-20.97	Average
12	18.23	33.45	9.28	10.03	52.76	74.00	-21.24	QP

Notes: Emission Level = Read Level +ISN Factor + Cable loss

Mode:e;

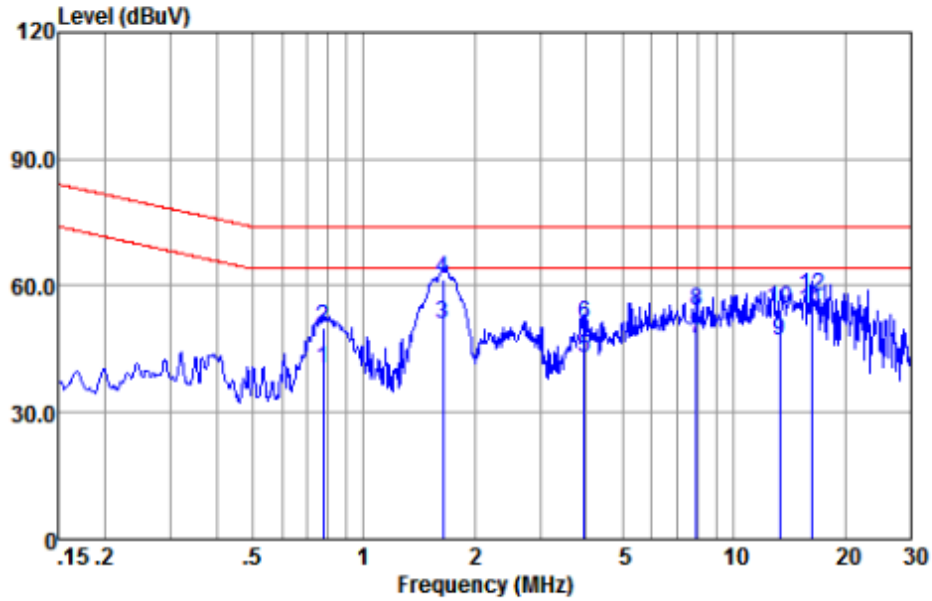

ISN : ISN CAT5
EUT/Project No : 2774IT
Test Mode : e

	Freq (MHz)	Read level (dBuV)	ISN Factor (dB)	Cable Loss (dB)	Emission Level (dBuV)	Limit (dBuV)	Over Limit (dB)	Remark
1	0.78	21.12	9.38	9.83	40.33	64.00	-23.67	Average
2	0.78	30.73	9.38	9.83	49.94	74.00	-24.06	QP
3	1.64	31.93	9.29	9.84	51.06	64.00	-12.94	Average
4	1.64	42.44	9.29	9.84	61.57	74.00	-12.43	QP
5	3.94	23.72	9.22	9.85	42.79	64.00	-21.21	Average
6	3.94	31.65	9.22	9.85	50.72	74.00	-23.28	QP
7	7.94	28.49	9.20	9.86	47.55	64.00	-16.45	Average
8	7.94	34.76	9.20	9.86	53.82	74.00	-20.18	QP
9	13.34	27.96	9.23	9.96	47.15	64.00	-16.85	Average
10	13.34	35.45	9.23	9.96	54.64	74.00	-19.36	QP
11	16.23	34.82	9.25	10.02	54.09	64.00	-9.91	Average
12	16.23	38.39	9.25	10.02	57.66	74.00	-16.34	QP

Notes: Emission Level = Read Level +ISN Factor + Cable loss

Mode:f;

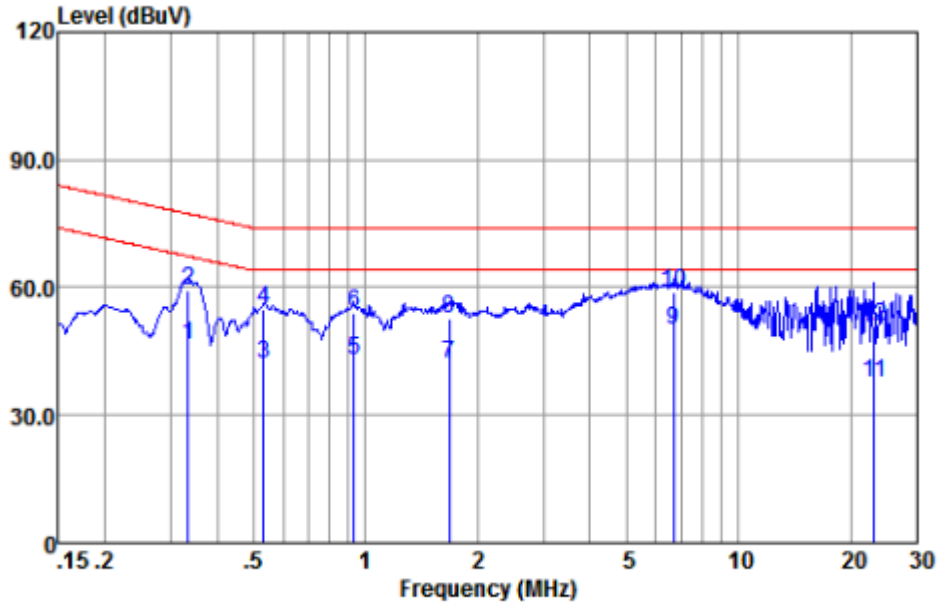

ISN : ISN CAT5
EUT/Project No : 2774IT
Test Mode : f

	Freq (MHz)	Read level (dBuV)	ISN Factor (dB)	Cable Loss (dB)	Emission Level (dBuV)	Limit (dBuV)	Over Limit (dB)	Remark
1	0.33	27.10	9.53	9.81	46.44	67.35	-20.91	Average
2	0.33	39.83	9.53	9.81	59.17	77.35	-18.18	QP
3	0.53	22.94	9.44	9.82	42.20	64.00	-21.80	Average
4	0.53	35.66	9.44	9.82	54.92	74.00	-19.08	QP
5	0.93	23.67	9.36	9.83	42.86	64.00	-21.14	Average
6	0.93	34.91	9.36	9.83	54.10	74.00	-19.90	QP
7	1.68	22.91	9.29	9.84	42.04	64.00	-21.96	Average
8	1.68	33.74	9.29	9.84	52.87	74.00	-21.13	QP
9	6.70	30.94	9.20	9.86	50.00	64.00	-14.00	Average
10	6.70	39.87	9.20	9.86	58.93	74.00	-15.07	QP
11	23.14	18.23	9.35	10.04	37.62	64.00	-26.38	Average
12	23.14	31.72	9.35	10.04	51.11	74.00	-22.89	QP

Notes: Emission Level = Read Level +ISN Factor + Cable loss

6.3 Radiated Emissions (30MHz-1GHz)

Test Requirement:	EN 55032:2015
Test Method:	EN 55032:2015
Frequency Range:	30MHz to 1GHz
Measurement Distance:	3m
Limit:	
30MHz-230MHz	40 dB(μV/m) quasi-peak
230MHz-1GHz	47 dB(μV/m) quasi-peak
Detector:	Peak for pre-scan (120kHz resolution bandwidth) 30M to 1000MHz

6.3.1 E.U.T. Operation

Operating Environment:

Temperature: 22 °C Humidity: 50 % RH Atmospheric Pressure: 1020 mbar

- Test mode:
- a: keep EUT previewing with DC12V support .
 - b: keep EUT previewing with PoE support .
 - c: keep DS-2CD2683G0-I previewing with DC12V support .
 - d: keep DS-2CD2683G0-I previewing with PoE support .
 - e: keep DS-2CD2663G0-I previewing with DC12V support .
 - f: keep DS-2CD2663G0-I previewing with PoE support .

6.3.2 Test Setup Diagram

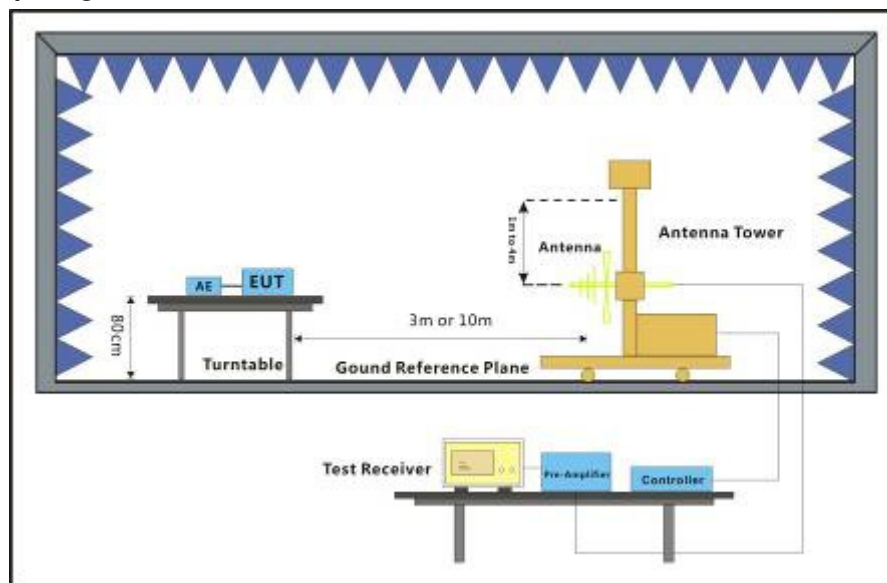

6.3.3 Measurement Data

An initial pre-scan was performed in the chamber using the spectrum analyser in peak detection mode. Quasi-peak measurements were conducted based on the peak sweep graph. The EUT was measured by BiConiLog antenna with 2 orthogonal polarities.

Notes : Emission Level=Read Level + Antenna Factor + Cable Loss – Preamp Factor



SGS-CSTC Standards Technical Services (Shanghai) Co., Ltd.

Report No.: SHEM180400277401
Page: 37 of 108

For old model
Mode:a; Polarization:Horizontal

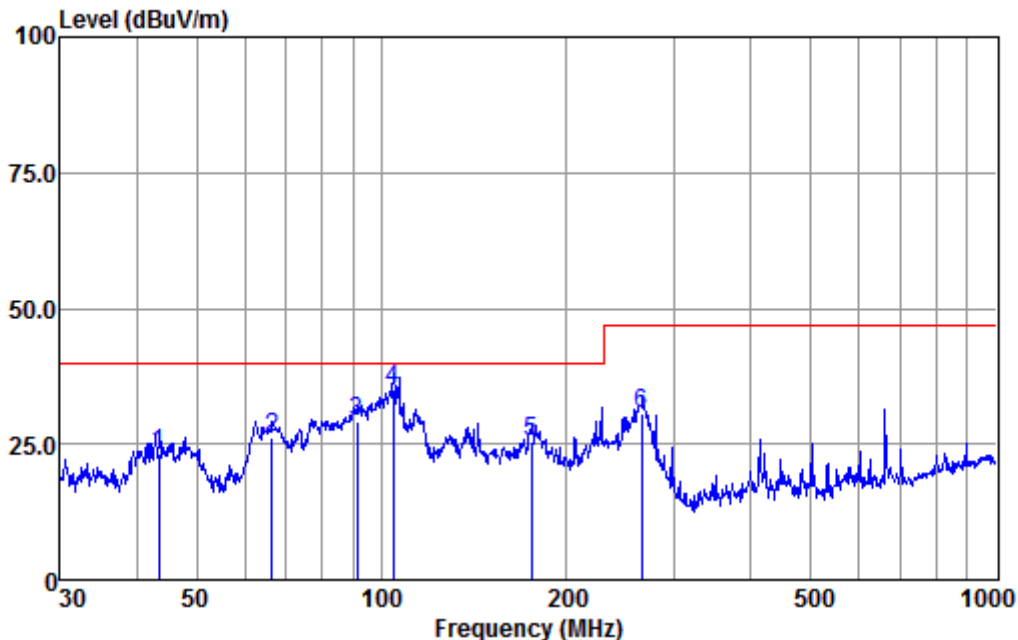

Condition : HORIZONTAL
EUT/Project: 8675IT
Test Mode : a

	Freq	ReadAntenna Level	Antenna Factor	Cable Loss	Preamp Factor	Level	Limit Line	Over Limit	Remark
	MHz	dBuV	dB/m	dB	dB	dBuV/m	dBuV/m	dB	
1	43.51	51.30	14.16	0.23	42.63	23.06	40.00	-16.94	QP
2	66.50	56.67	11.81	0.32	42.66	26.14	40.00	-13.86	QP
3	91.17	63.21	8.29	0.42	42.68	29.24	40.00	-10.76	QP
4 q	104.54	67.63	9.55	0.47	42.69	34.96	40.00	-5.04	QP
5	175.65	55.60	11.77	0.66	42.56	25.47	40.00	-14.53	QP
6	265.68	60.25	12.05	0.79	42.44	30.65	47.00	-16.35	QP



Mode:a; Polarization:Vertical

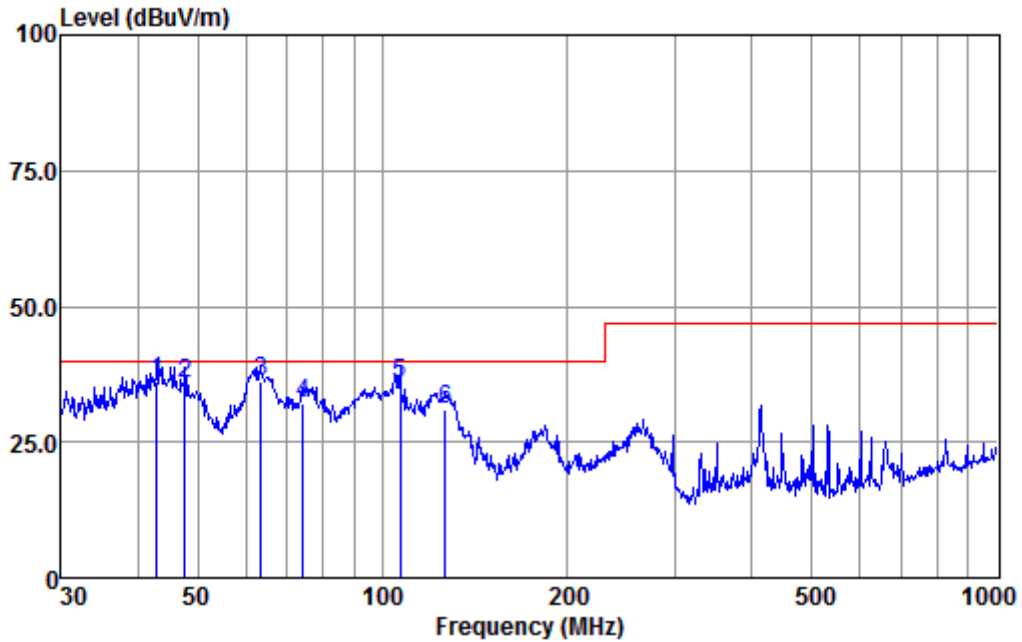

Condition : VERTICAL
EUT/Project: 8675IT
Test Mode : a

	Freq	ReadAntenna Level	Antenna Factor	Cable Loss	Preamp Factor	Level	Limit Line	Over Limit	Remark
	MHz	dBuV	dB/m	dB	dB	dBuV/m	dBuV/m	dB	
1 q	42.90	64.14	14.52	0.23	42.63	36.26	40.00	-3.74	QP
2	47.66	66.22	11.85	0.25	42.64	35.68	40.00	-4.32	QP
3	63.54	66.29	12.16	0.31	42.66	36.10	40.00	-3.90	QP
4	74.40	64.45	9.88	0.36	42.67	32.02	40.00	-7.98	QP
5	106.76	68.52	9.57	0.49	42.70	35.88	40.00	-4.12	QP
6	126.77	61.13	11.95	0.56	42.66	30.98	40.00	-9.02	QP



SGS-CSTC Standards Technical Services (Shanghai) Co., Ltd.

Report No.: SHEM180400277401
Page: 39 of 108

Mode:b; Polarization:Horizontal

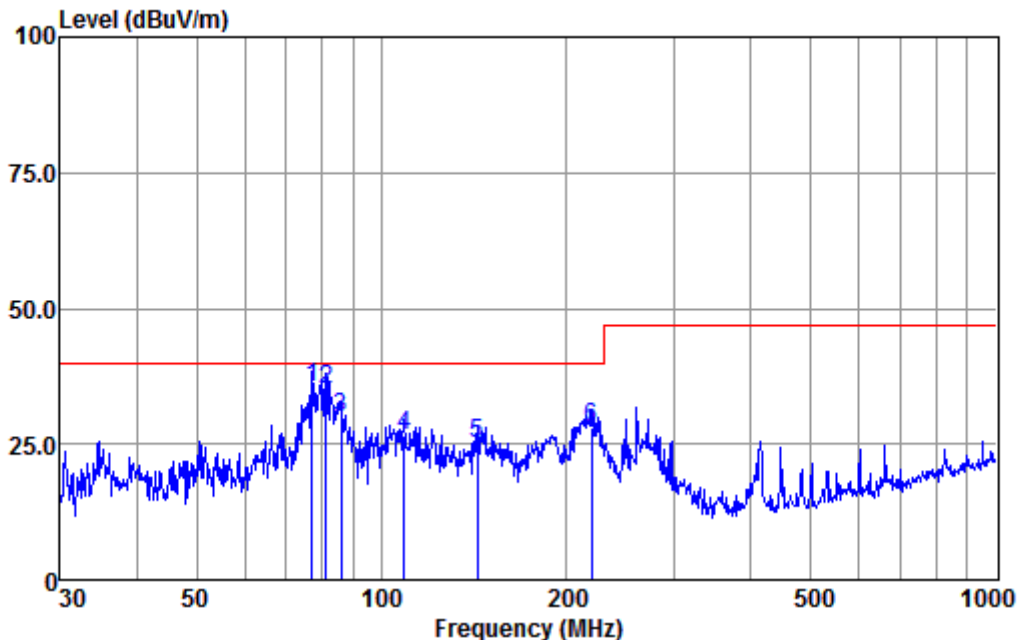

Condition : HORIZONTAL
EUT/Project: 8675IT
Test Mode : b

	ReadAntenna	Cable	Preamp	Limit	Over			
Freq	Level	Factor	Loss	Factor	Level	Line	Limit	Remark
MHz	dBuV	dB/m	dB	dB	dBuV/m	dBuV/m	dB	
1 q	77.05	68.70	8.98	0.37	42.67	35.38	40.00	-4.62 QP
2	81.21	69.26	8.01	0.38	42.68	34.97	40.00	-5.03 QP
3	85.90	64.07	8.06	0.40	42.68	29.85	40.00	-10.15 QP
4	109.03	59.04	9.59	0.49	42.70	26.42	40.00	-13.58 QP
5	143.33	55.65	11.51	0.61	42.63	25.14	40.00	-14.86 QP
6	219.84	59.45	10.28	0.72	42.49	27.96	40.00	-12.04 QP



Mode:b; Polarization:Vertical

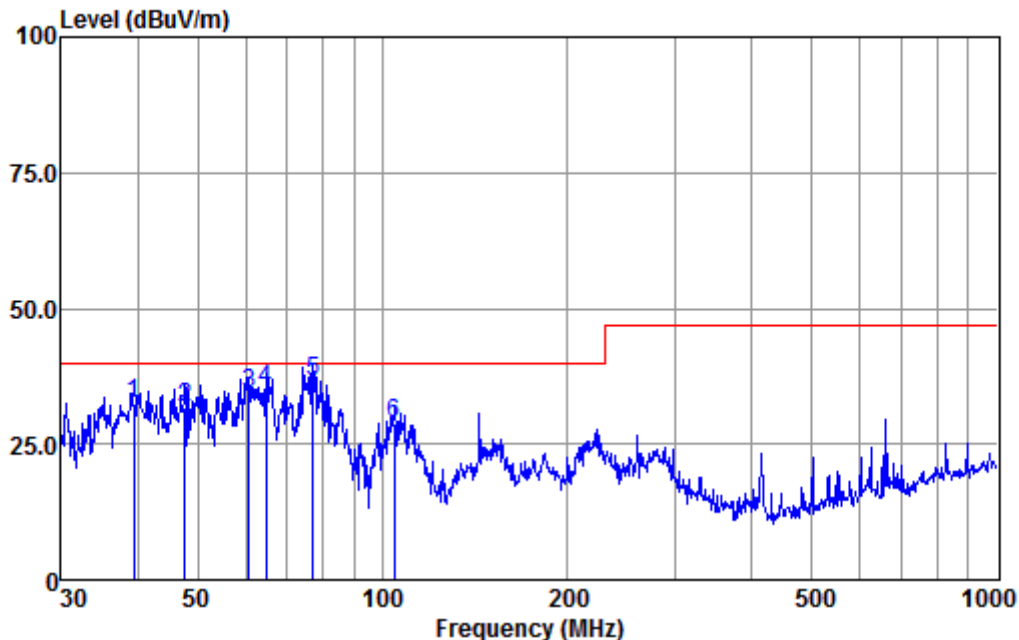

Condition : VERTICAL
EUT/Project: 8675IT
Test Mode : b

	ReadAntenna	Cable	Preamp	Limit	Over			
Freq	Level	Factor	Loss	Factor	Level	Line	Limit	Remark
MHz	dBuV	dB/m	dB	dB	dBuV/m	dBuV/m	dB	
1	39.44	58.76	16.25	0.22	42.62	32.61	40.00	-7.39 QP
2	47.66	62.32	11.85	0.25	42.64	31.78	40.00	-8.22 QP
3	60.70	64.18	12.52	0.30	42.65	34.35	40.00	-5.65 QP
4	64.66	65.41	12.03	0.32	42.66	35.10	40.00	-4.90 QP
5 q	77.05	69.84	8.98	0.37	42.67	36.52	40.00	-3.48 QP
6	104.54	61.37	9.55	0.47	42.69	28.70	40.00	-11.30 QP



SGS-CSTC Standards Technical Services (Shanghai) Co., Ltd.

Report No.: SHEM180400277401
Page: 41 of 108

For new model
Mode:c; Polarization:Horizontal

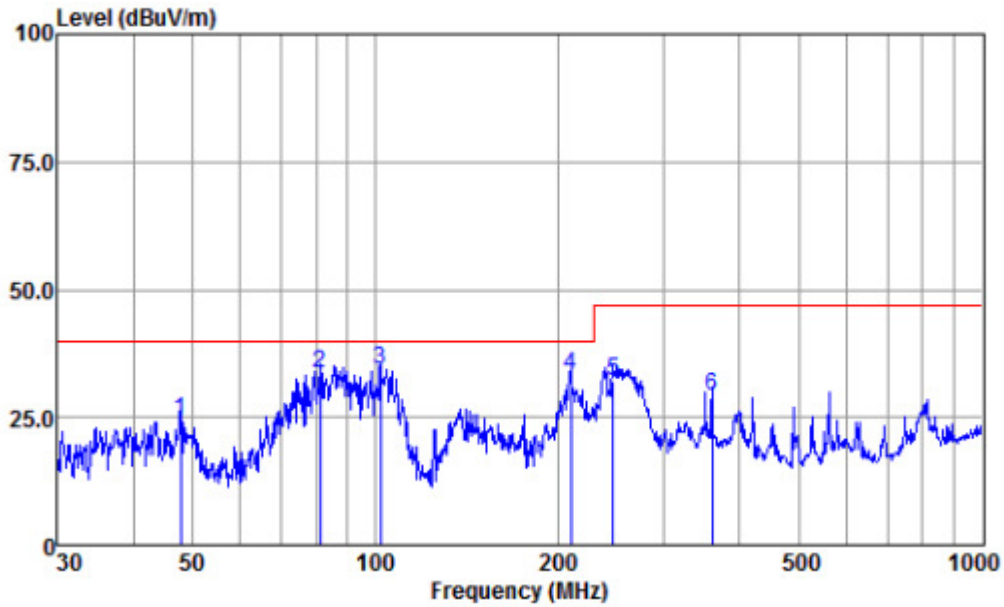

Antenna Polarity :HORIZONTAL
EUT/Project :2774IT
Test mode :c

	Read	Antenna	Cable	Preamp	Emission	Limit	Over	
Freq	Level	Factor	Loss	Factor	Level	Line	Limit	Remark
MHz	dBuv	dB/m	dB	dB	dBuv/m	dBuv/m	dB	
1	47.83	55.10	11.76	0.25	42.64	24.47	40.00	-15.53 QP
2	81.21	67.79	8.01	0.38	42.68	33.50	40.00	-6.50 QP
3	102.00	67.02	9.52	0.46	42.69	34.31	40.00	-5.69 QP
4	210.79	65.16	9.89	0.71	42.51	33.25	40.00	-6.75 QP
5	247.68	62.32	11.40	0.77	42.46	32.03	47.00	-14.97 QP
6	360.45	55.96	14.40	0.93	42.21	29.08	47.00	-17.92 QP

Note:Emission Level=Read Level+Antenna Factor+Cable loss-Preamp Factor



SGS-CSTC Standards Technical Services (Shanghai) Co., Ltd.

Report No.: SHEM180400277401
Page: 42 of 108

Mode:c; Polarization:Vertical

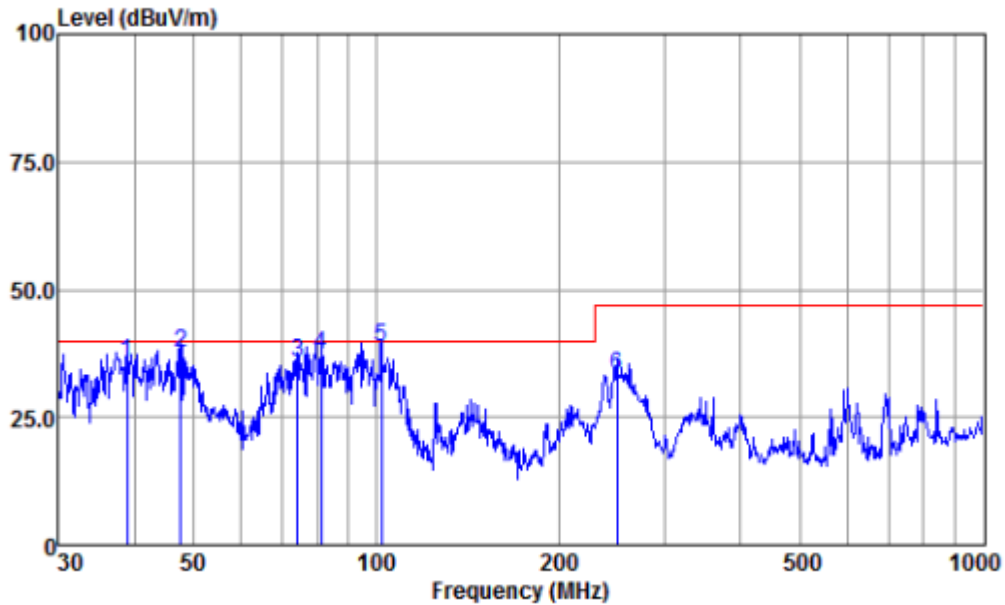

Antenna Polarity :VERTICAL
EUT/Project :2774IT
Test mode :c

	Freq	Read Level	Antenna Factor	Cable Loss	Preamp Factor	Emission Level	Limit Line	Over Limit	Remark
	MHz	dBuv	dB/m	dB	dB	dBuv/m	dBuv/m	dB	
1	38.89	61.96	16.20	0.22	42.62	35.76	40.00	-4.24	QP
2	47.66	68.07	11.85	0.25	42.64	37.53	40.00	-2.47	QP
3	74.40	68.16	9.88	0.36	42.67	35.73	40.00	-4.27	QP
4	81.21	71.65	8.01	0.38	42.68	37.36	40.00	-2.64	QP
5	102.00	71.39	9.52	0.46	42.69	38.68	40.00	-1.32	QP
6	250.30	63.40	11.50	0.77	42.46	33.21	47.00	-13.79	QP

Note:Emission Level=Read Level+Antenna Factor+Cable loss-Preamp Factor



SGS-CSTC Standards Technical Services (Shanghai) Co., Ltd.

Report No.: SHEM180400277401
Page: 43 of 108

Mode:d; Polarization:Horizontal

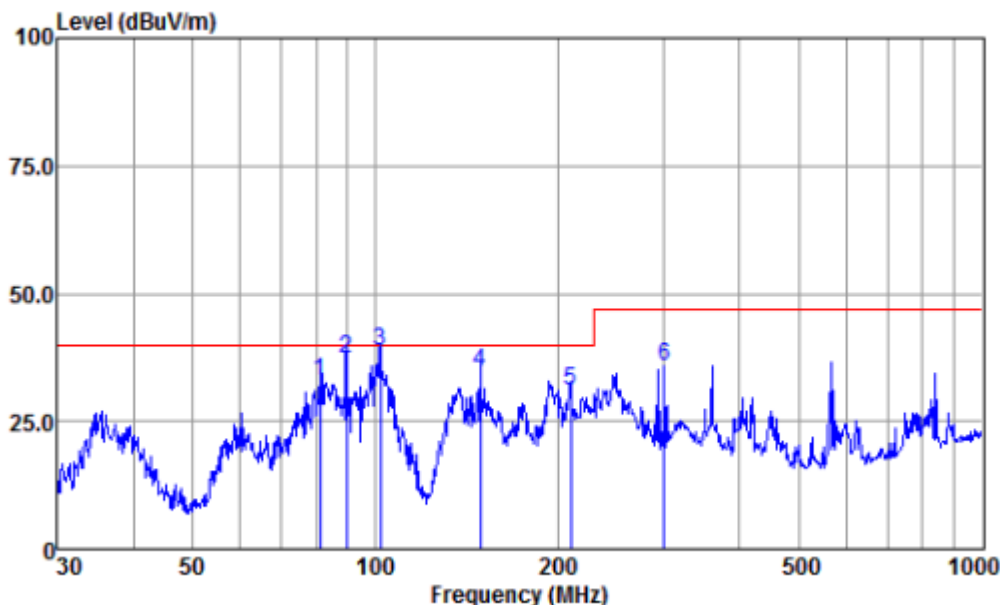

Antenna Polarity :HORIZONTAL
EUT/Project :2774IT
Test mode :d

	Read	Antenna	Cable	Preamp	Emission	Limit	Over	
Freq	Level	Factor	Loss	Factor	Level	Line	Limit	Remark
-----	-----	-----	-----	-----	-----	-----	-----	-----
MHz	dBuv	dB/m	dB	dB	dBuv/m	dBuv/m	dB	
1	81.21	67.28	8.01	0.38	42.68	32.99	40.00	-7.01 QP
2	89.90	71.49	8.10	0.42	42.68	37.33	40.00	-2.67 QP
3	102.00	71.60	9.52	0.46	42.69	38.89	40.00	-1.11 QP
4	149.49	64.77	11.87	0.62	42.61	34.65	40.00	-5.35 QP
5	210.79	62.87	9.89	0.71	42.51	30.96	40.00	-9.04 QP
6	300.37	64.04	13.20	0.84	42.40	35.68	47.00	-11.32 QP

Note:Emission Level=Read Level+Antenna Factor+Cable loss-Preamp Factor



SGS-CSTC Standards Technical Services (Shanghai) Co., Ltd.

Report No.: SHEM180400277401
Page: 44 of 108

Mode:d; Polarization:Vertical

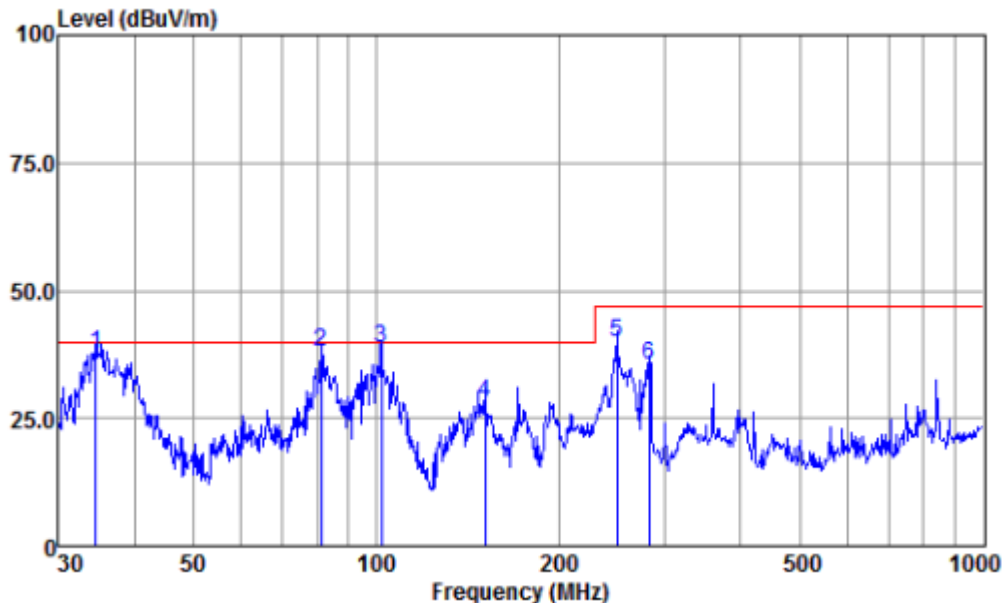

Antenna Polarity :VERTICAL
EUT/Project :2774IT
Test mode :d

	Read Freq	Read Level	Antenna Factor	Cable Loss	Preamp Factor	Emission Level	Limit Line	Over Limit	Remark
	MHz	dBuv	dB/m	dB	dB	dBuv/m	dBuv/m	dB	
1	34.52	64.22	15.79	0.20	42.61	37.60	40.00	-2.40	QP
2	81.21	72.26	8.01	0.38	42.68	37.97	40.00	-2.03	QP
3	102.00	71.40	9.52	0.46	42.69	38.69	40.00	-1.31	QP
4	151.60	57.82	12.10	0.62	42.61	27.93	40.00	-12.07	QP
5	250.30	70.13	11.50	0.77	42.46	39.94	47.00	-7.06	QP
6	281.99	64.23	12.61	0.82	42.42	35.24	47.00	-11.76	QP

Note:Emission Level=Read Level+Antenna Factor+Cable loss-Preamp Factor



SGS-CSTC Standards Technical Services (Shanghai) Co., Ltd.

Report No.: SHEM180400277401
Page: 45 of 108

Mode:e; Polarization:Horizontal

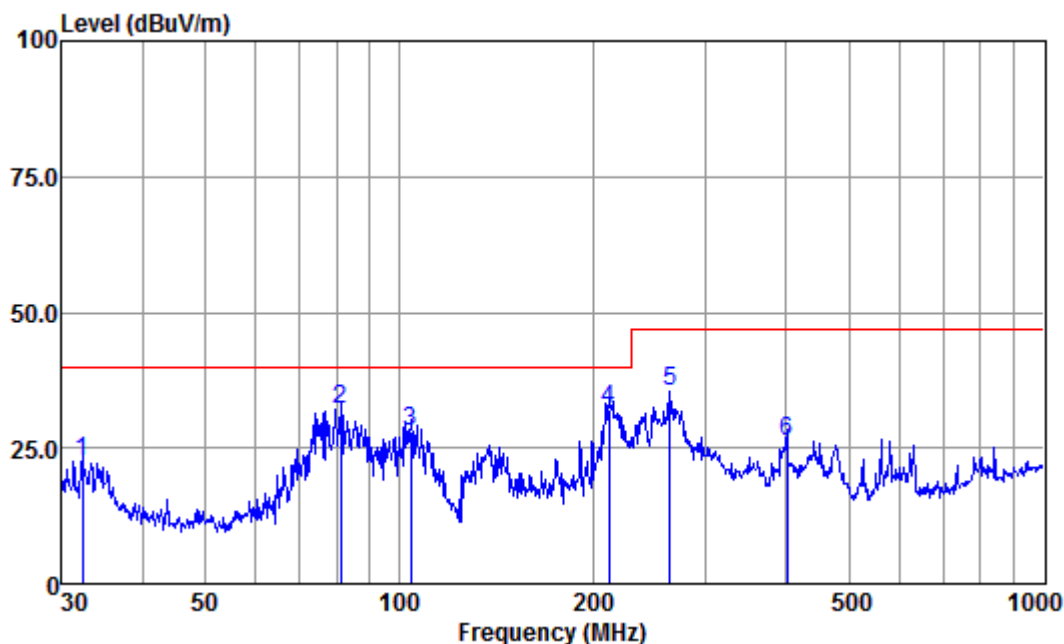

Antenna Polarity :HORIZONTAL
EUT/Project :2774IT
Test mode :e

	Read	Antenna	Cable	Preamp	Emission	Limit	Over	
Freq	Level	Factor	Loss	Factor	Level	Line	Limit	Remark
MHz	dBuv	dB/m	dB	dB	dBuv/m	dBuv/m	dB	
1	32.29	49.31	15.56	0.19	42.61	22.45	40.00	-17.55 QP
2	81.21	66.47	8.01	0.38	42.68	32.18	40.00	-7.82 QP
3	104.54	60.86	9.55	0.47	42.69	28.19	40.00	-11.81 QP
4	212.27	63.81	9.96	0.71	42.51	31.97	40.00	-8.03 QP
5	263.82	65.01	11.99	0.79	42.44	35.35	47.00	-11.65 QP
6	400.43	52.24	15.10	1.00	42.10	26.24	47.00	-20.76 QP

Note:Emission Level=Read Level+Antenna Factor+Cable loss-Preamp Factor



SGS-CSTC Standards Technical Services (Shanghai) Co., Ltd.

Report No.: SHEM180400277401
Page: 46 of 108

Mode:e; Polarization:Vertical

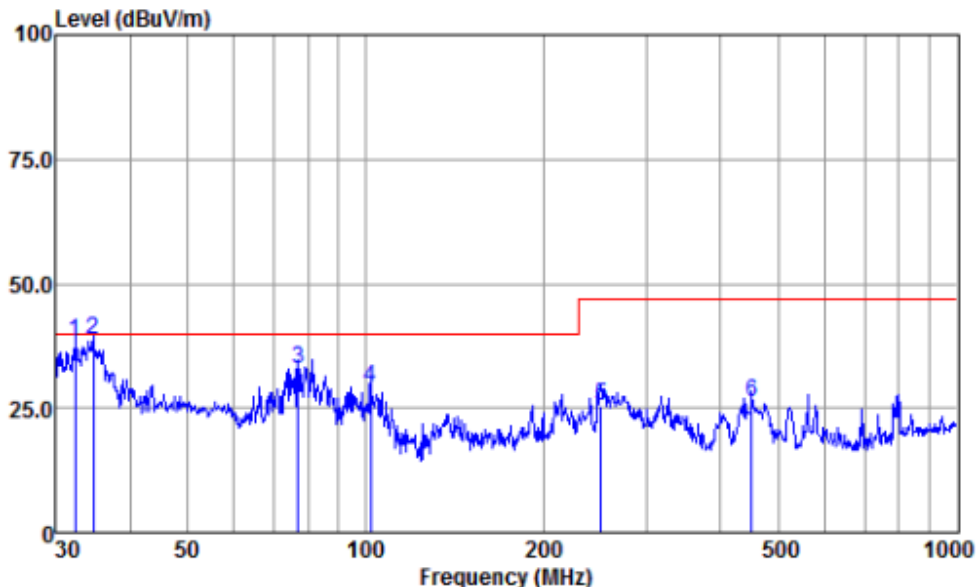

Antenna Polarity :VERTICAL
EUT/Project :2774IT
Test mode :e

	Read	Antenna	Cable	Preamp	Emission	Limit	Over	
Freq	Level	Factor	Loss	Factor	Level	Line	Limit	Remark
-----	-----	-----	-----	-----	-----	-----	-----	-----
MHz	dBuv	dB/m	dB	dB	dBuv/m	dBuv/m	dB	
1	32.29	65.21	15.56	0.19	42.61	38.35	40.00	-1.65 QP
2	34.64	65.23	15.80	0.20	42.61	38.62	40.00	-1.38 QP
3	77.05	66.18	8.98	0.37	42.67	32.86	40.00	-7.14 QP
4	102.00	61.81	9.52	0.46	42.69	29.10	40.00	-10.90 QP
5	251.18	55.79	11.53	0.77	42.46	25.63	47.00	-21.37 QP
6	451.14	51.05	16.23	1.09	42.12	26.25	47.00	-20.75 QP

Note:Emission Level=Read Level+Antenna Factor+Cable loss-Preamp Factor



SGS-CSTC Standards Technical Services (Shanghai) Co., Ltd.

Report No.: SHEM180400277401
Page: 47 of 108

Mode:f; Polarization:Horizontal

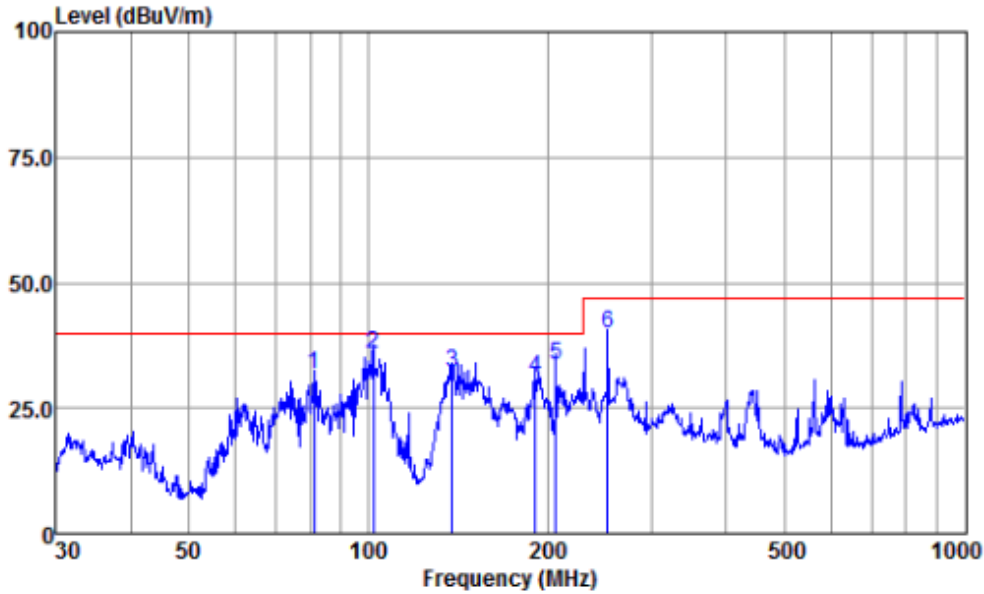

Antenna Polarity :HORIZONTAL
EUT/Project :2774IT
Test mode :f

	Read	Antenna	Cable	Preamp	Emission	Limit	Over	
Freq	Level	Factor	Loss	Factor	Level	Line	Limit	Remark
-----	-----	-----	-----	-----	-----	-----	-----	-----
MHz	dBuV	dB/m	dB	dB	dBuV/m	dBuV/m	dB	
1	81.21	65.88	8.01	0.38	42.68	31.59	40.00	-8.41 QP
2	102.00	68.40	9.52	0.46	42.69	35.69	40.00	-4.31 QP
3	138.39	62.65	11.51	0.60	42.64	32.12	40.00	-7.88 QP
4	191.07	62.54	10.18	0.68	42.54	30.86	40.00	-9.14 QP
5	207.12	65.78	9.73	0.70	42.51	33.70	40.00	-6.30 QP
6	252.95	69.83	11.59	0.77	42.45	39.74	47.00	-7.26 QP

Note:Emission Level=Read Level+Antenna Factor+Cable loss-Preamp Factor



Mode:f; Polarization:Vertical

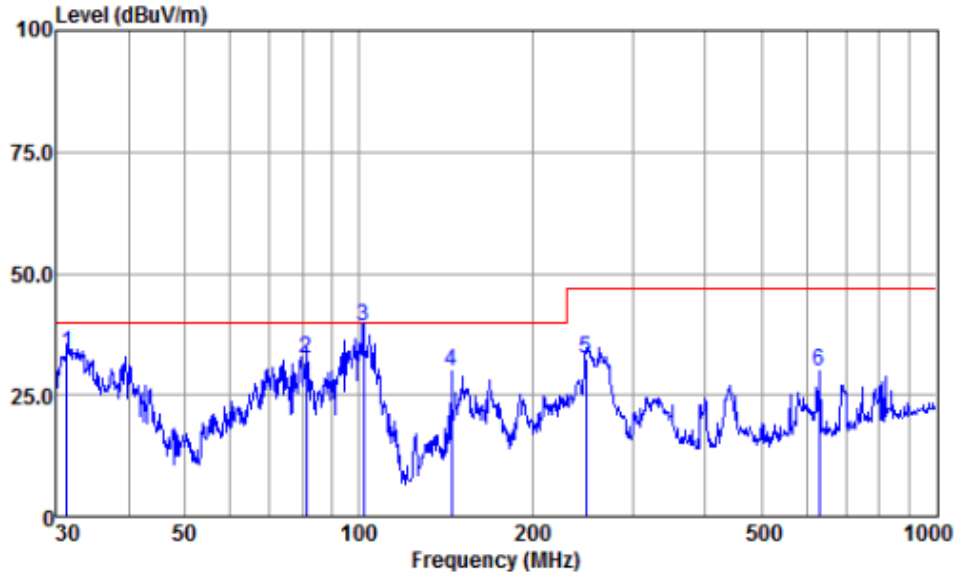

Antenna Polarity :VERTICAL
EUT/Project :2774IT
Test mode :f

	Freq	Read Level	Antenna Factor	Cable Loss	Preamp Factor	Emission Level	Limit Line	Over Limit	Remark
	MHz	dBuv	dB/m	dB	dB	dBuv/m	dBuv/m	dB	
1	31.29	60.38	15.45	0.19	42.60	33.42	40.00	-6.58	QP
2	81.21	66.85	8.01	0.38	42.68	32.56	40.00	-7.44	QP
3	102.00	71.65	9.52	0.46	42.69	38.94	40.00	-1.06	QP
4	144.84	60.20	11.60	0.61	42.62	29.79	40.00	-10.21	QP
5	248.55	62.88	11.43	0.77	42.46	32.62	47.00	-14.38	QP
6	629.48	50.82	19.65	1.45	42.20	29.72	47.00	-17.28	QP

Note:Emission Level=Read Level+Antenna Factor+Cable loss-Preamp Factor

6.4 Radiated Emissions (above 1GHz)

Test Requirement:	EN 55032:2015
Test Method:	EN 55032:2015
Frequency Range:	Above 1GHz
Measurement Distance:	3m
Limit:	
1GHz-3GHz	70 dB(μV/m) peak, 50 dB(μV/m) average
3GHz-6GHz	74 dB(μV/m) peak, 54dB(μV/m) average
Detector:	Peak for pre-scan (1000kHz resolution bandwidth) 1000M to 6000MHz

6.4.1 E.U.T. Operation

Operating Environment:

Temperature: 22 °C Humidity: 50 % RH Atmospheric Pressure: 1020 mbar

- Test mode:
- a: keep EUT previewing with DC12V support .
 - b: keep EUT previewing with PoE support .
 - c: keep DS-2CD2683G0-I previewing with DC12V support .
 - d: keep DS-2CD2683G0-I previewing with PoE support .
 - e: keep DS-2CD2663G0-I previewing with DC12V support .
 - f: keep DS-2CD2663G0-I previewing with PoE support .

6.4.2 Test Setup Diagram

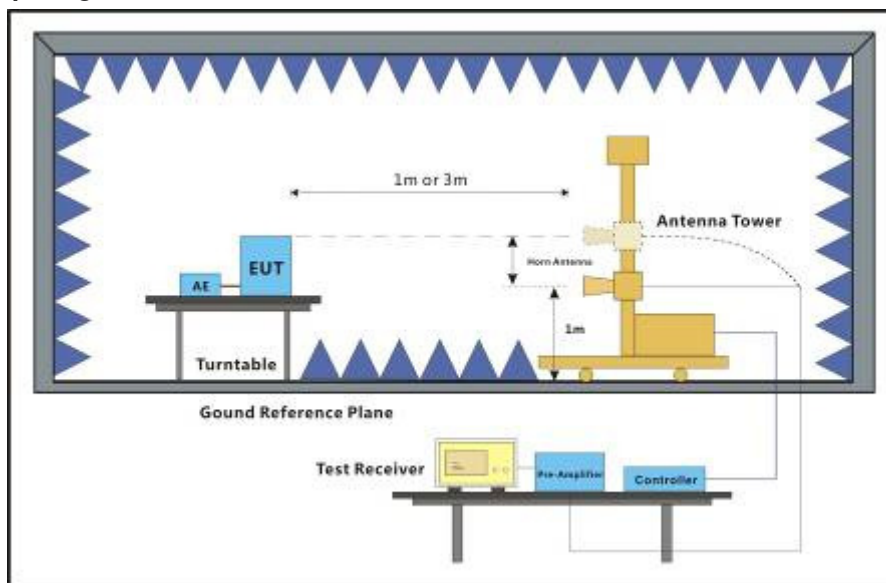

6.4.3 Measurement Data

An initial pre-scan was performed in the chamber using the spectrum analyser in peak detection mode. Quasi-peak measurements were conducted based on the peak sweep graph. The EUT was measured by BiConiLog antenna with 2 orthogonal polarities.

Notes : Emission Level=Read Level + Antenna Factor + Cable Loss – Preamp Factor



SGS-CSTC Standards Technical Services (Shanghai) Co., Ltd.

Report No.: SHEM180400277401
Page: 50 of 108

For old model
Mode:a; Polarization:Horizontal

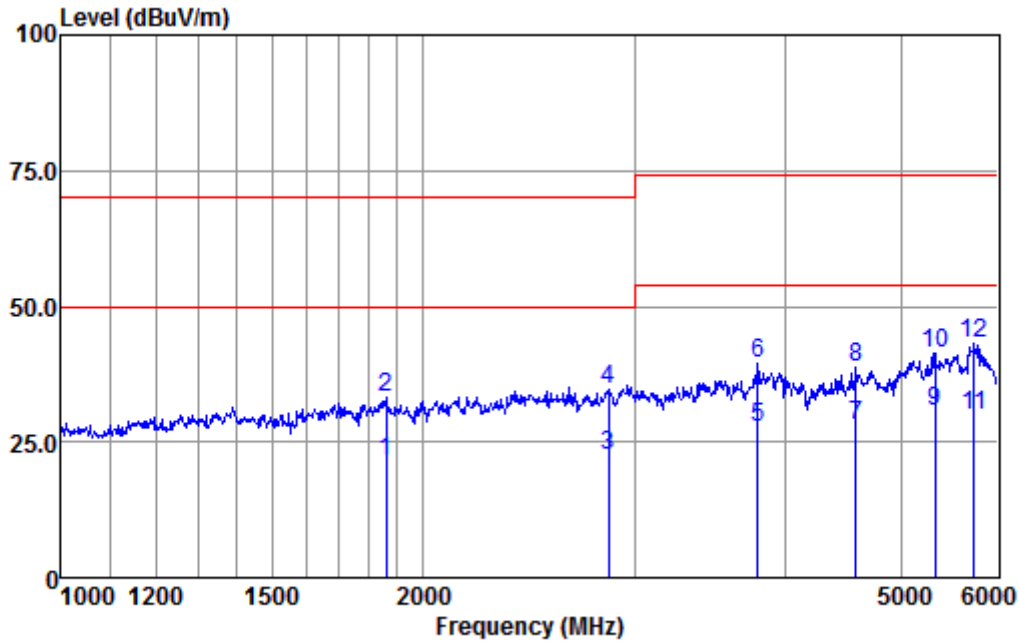

Condition : HORIZONTAL
EUT/Project: 8675IT
Test mode : a

	Freq	ReadAntenna Level	Antenna Factor	Cable Loss	Preamp Factor	Level	Limit Line	Over Limit	Remark
	MHz	dBuV	dB/m	dB	dB	dBuV/m	dBuV/m	dB	
1	1862.17	33.64	25.80	4.29	42.15	21.58	50.00	-28.42	Average
2	1862.17	45.17	25.80	4.29	42.15	33.11	70.00	-36.89	Peak
3	2852.45	30.56	28.20	5.69	41.83	22.62	50.00	-27.38	Average
4	2852.45	42.78	28.20	5.69	41.83	34.84	70.00	-35.16	Peak
5	3799.47	33.36	29.36	6.70	41.92	27.50	54.00	-26.50	Average
6	3799.47	45.23	29.36	6.70	41.92	39.37	74.00	-34.63	Peak
7	4585.94	30.98	30.79	7.89	41.65	28.01	54.00	-25.99	Average
8	4585.94	41.71	30.79	7.89	41.65	38.74	74.00	-35.26	Peak
9	5330.81	32.29	31.80	8.26	41.88	30.47	54.00	-23.53	Average
10	5330.81	43.23	31.80	8.26	41.88	41.41	74.00	-32.59	Peak
11	5747.46	31.18	32.25	8.36	41.92	29.87	54.00	-24.13	Average
12 p	5747.46	44.39	32.25	8.36	41.92	43.08	74.00	-30.92	Peak

Mode:a; Polarization:Vertical

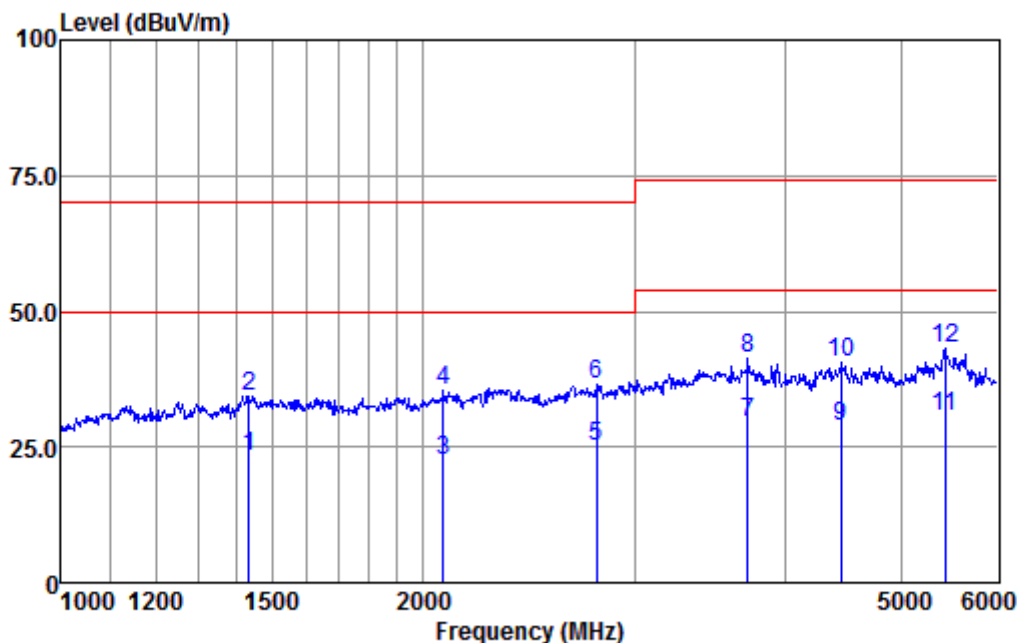

Condition : VERTICAL
EUT/Project: 8675IT
Test mode : a

	Freq	ReadAntenna Level	Antenna Factor	Cable Loss	Preamp Factor	Level	Limit Line	Over Limit	Remark
	MHz	dBuV	dB/m	dB	dB	dBuV/m	dBuV/m	dB	
1	1433.54	36.45	25.08	3.75	41.91	23.37	50.00	-26.63	Average
2	1433.54	47.56	25.08	3.75	41.91	34.48	70.00	-35.52	Peak
3	2080.96	33.83	26.25	4.60	42.21	22.47	50.00	-27.53	Average
4	2080.96	46.77	26.25	4.60	42.21	35.41	70.00	-34.59	Peak
5	2786.78	33.15	28.06	5.64	41.89	24.96	50.00	-25.04	Average
6	2786.78	44.61	28.06	5.64	41.89	36.42	70.00	-33.58	Peak
7	3725.32	35.72	29.22	6.51	41.91	29.54	54.00	-24.46	Average
8	3725.32	47.64	29.22	6.51	41.91	41.46	74.00	-32.54	Peak
9	4456.34	32.39	30.53	7.70	41.68	28.94	54.00	-25.06	Average
10	4456.34	43.92	30.53	7.70	41.68	40.47	74.00	-33.53	Peak
11	5436.92	32.54	31.86	8.28	41.96	30.72	54.00	-23.28	Average
12 p	5436.92	44.84	31.86	8.28	41.96	43.02	74.00	-30.98	Peak

Mode:b; Polarization:Horizontal

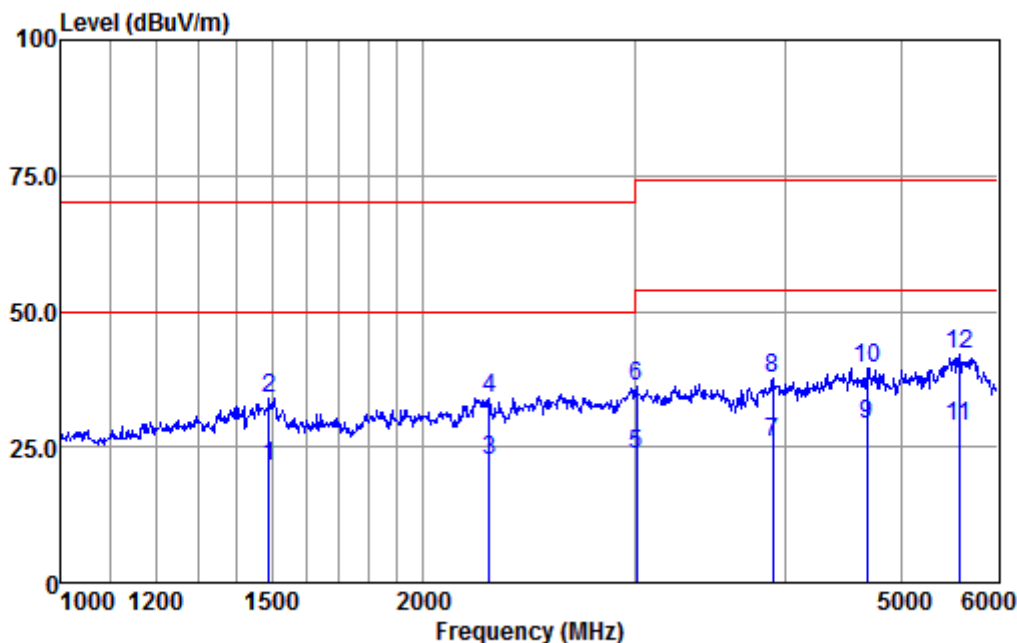

Condition : HORIZONTAL
EUT/Project: 8675IT
Test mode : b

	Freq	ReadAntenna Level	Antenna Factor	Cable Loss	Preamp Factor	Level	Limit Line	Over Limit	Remark
	MHz	dBuV	dB/m	dB	dB	dBuV/m	dBuV/m	dB	
1	1488.50	34.27	25.18	3.80	41.93	21.32	50.00	-28.68	Average
2	1488.50	46.96	25.18	3.80	41.93	34.01	70.00	-35.99	Peak
3	2271.92	32.88	26.80	4.99	42.19	22.48	50.00	-27.52	Average
4	2271.92	44.33	26.80	4.99	42.19	33.93	70.00	-36.07	Peak
5	3009.98	31.06	28.51	5.83	41.71	23.69	54.00	-30.31	Average
6	3009.98	43.70	28.51	5.83	41.71	36.33	74.00	-37.67	Peak
7	3909.97	31.14	29.55	6.90	41.94	25.65	54.00	-28.35	Average
8	3909.97	43.06	29.55	6.90	41.94	37.57	74.00	-36.43	Peak
9	4677.23	31.78	30.98	7.95	41.64	29.07	54.00	-24.93	Average
10	4677.23	42.25	30.98	7.95	41.64	39.54	74.00	-34.46	Peak
11	5585.03	30.42	32.02	8.32	41.98	28.78	54.00	-25.22	Average
12 p	5585.03	43.79	32.02	8.32	41.98	42.15	74.00	-31.85	Peak



SGS-CSTC Standards Technical Services (Shanghai) Co., Ltd.

Report No.: SHEM180400277401
Page: 53 of 108

Mode:b; Polarization:Vertical

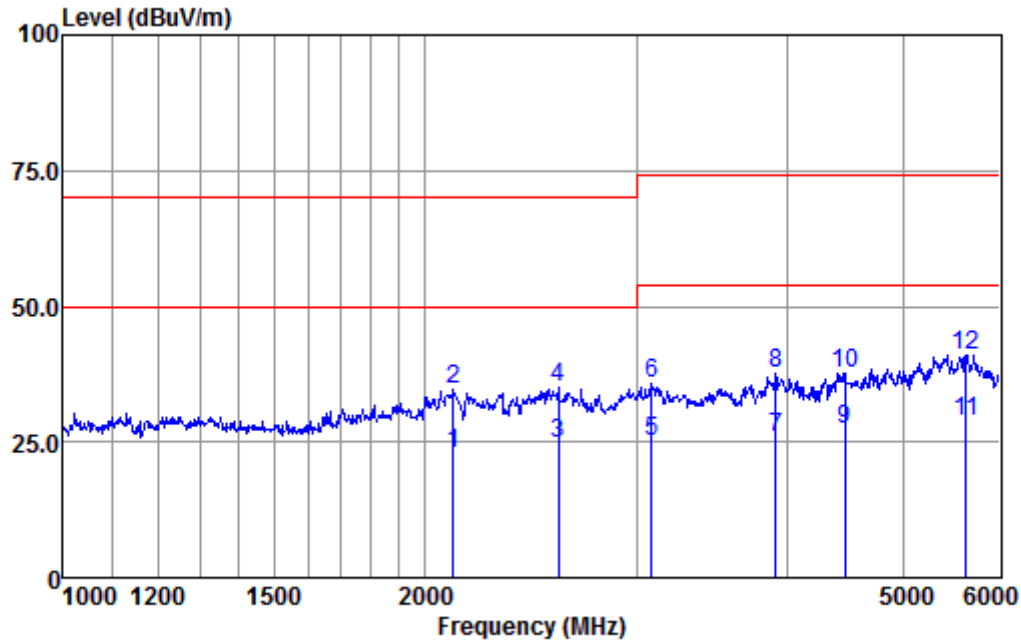

Condition : VERTICAL
EUT/Project: 8675IT
Test mode : b

	ReadAntenna	Cable	Preamp	Limit	Over				
Freq	Level	Factor	Loss	Factor	Level	Line	Limit	Remark	
MHz	dBuV	dB/m	dB	dB	dBuV/m	dBuV/m	dB		
1	2111.00	33.98	26.35	4.67	42.21	22.79	50.00	-27.21 Average	
2	2111.00	45.73	26.35	4.67	42.21	34.54	70.00	-35.46 Peak	
3	2580.13	33.73	27.59	5.42	42.09	24.65	50.00	-25.35 Average	
4	2580.13	44.07	27.59	5.42	42.09	34.99	70.00	-35.01 Peak	
5	3086.44	32.55	28.56	5.85	41.74	25.22	54.00	-28.78 Average	
6	3086.44	43.11	28.56	5.85	41.74	35.78	74.00	-38.22 Peak	
7	3916.98	31.35	29.55	6.90	41.94	25.86	54.00	-28.14 Average	
8	3916.98	43.06	29.55	6.90	41.94	37.57	74.00	-36.43 Peak	
9	4472.34	30.61	30.56	7.70	41.67	27.20	54.00	-26.80 Average	
10	4472.34	41.02	30.56	7.70	41.67	37.61	74.00	-36.39 Peak	
11	5635.29	30.20	32.09	8.34	41.96	28.67	54.00	-25.33 Average	
12 p	5635.29	42.54	32.09	8.34	41.96	41.01	74.00	-32.99 Peak	



SGS-CSTC Standards Technical Services (Shanghai) Co., Ltd.

Report No.: SHEM180400277401
Page: 54 of 108

For new model
Mode:c; Polarization:Horizontal

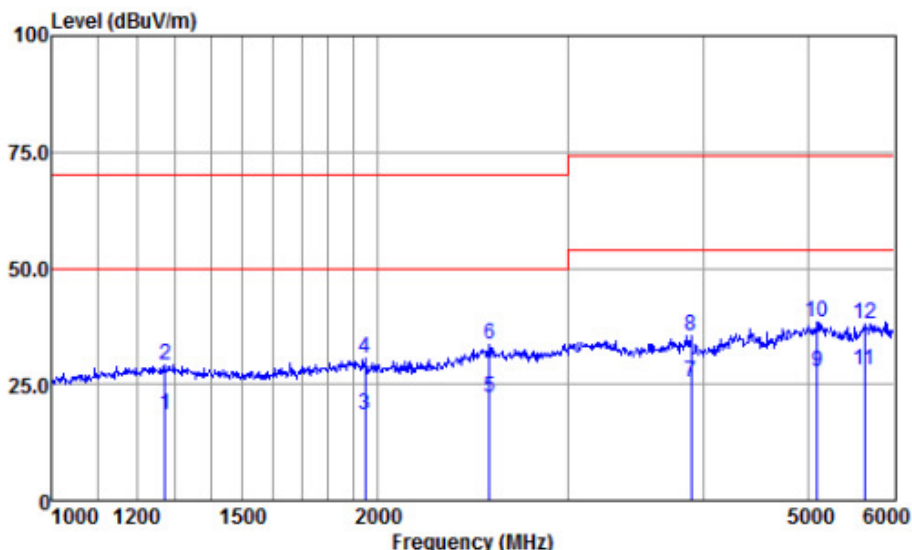

Antenna Polarity :HORIZONTAL
EUT/Project :2774IT
Test mode :c

	Read	Antenna	Cable	Preamp	Emission	Limit	Over	
Freq	Level	Factor	Loss	Factor	Level	Line	Limit	Remark
-----	-----	-----	-----	-----	-----	-----	-----	-----
MHz	dBuv	dB/m	dB	dB	dBuv/m	dBuv/m	dB	
1	1271.37	31.91	24.75	3.48	41.85	18.29	50.00	-31.71 Average
2	1271.37	42.80	24.75	3.48	41.85	29.18	70.00	-40.82 Peak
3	1947.48	30.21	25.93	4.39	42.19	18.34	50.00	-31.66 Average
4	1947.48	42.57	25.93	4.39	42.19	30.70	70.00	-39.30 Peak
5	2538.86	31.56	27.49	5.37	42.13	22.29	50.00	-27.71 Average
6	2538.86	42.87	27.49	5.37	42.13	33.60	70.00	-36.40 Peak
7	3902.97	30.98	29.53	6.90	41.94	25.47	54.00	-28.53 Average
8	3902.97	41.06	29.53	6.90	41.94	35.55	74.00	-38.45 Peak
9	5106.43	29.47	31.66	8.21	41.69	27.65	54.00	-26.35 Average
10	5106.43	40.31	31.66	8.21	41.69	38.49	74.00	-35.51 Peak
11	5645.39	29.48	32.11	8.34	41.96	27.97	54.00	-26.03 Average
12	5645.39	39.37	32.11	8.34	41.96	37.86	74.00	-36.14 Peak

Note:Emission Level=Read Level+Antenna Factor+Cable loss-Preamp Factor



SGS-CSTC Standards Technical Services (Shanghai) Co., Ltd.

Report No.: SHEM180400277401
Page: 55 of 108

Mode:c; Polarization:Vertical

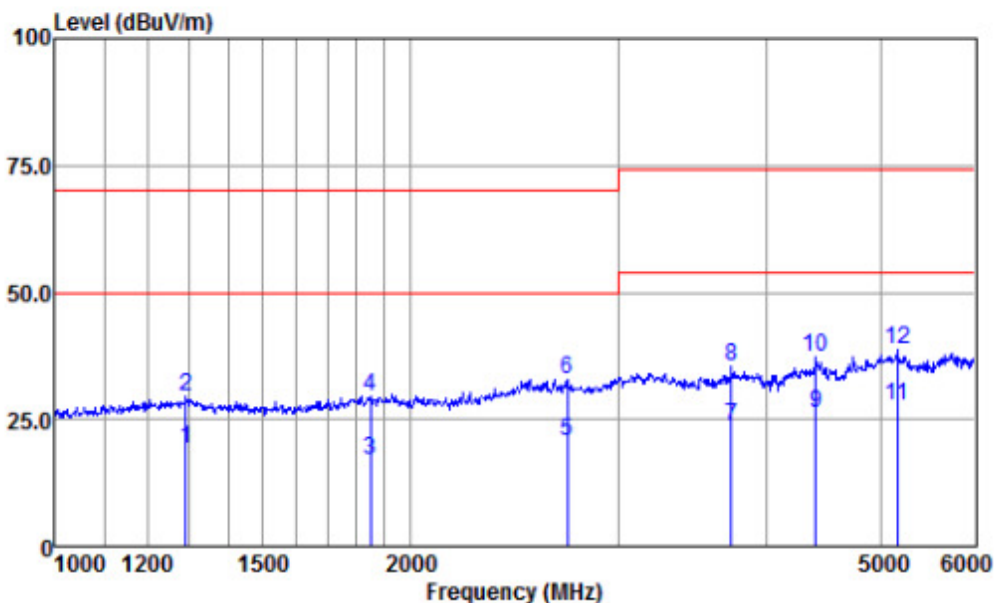

Antenna Polarity :VERTICAL
EUT/Project :2774IT
Test mode :c

	Read	Antenna	Cable	Preamp	Emission	Limit	Over	
Freq	Level	Factor	Loss	Factor	Level	Line	Limit	Remark
MHz	dBuV	dB/m	dB	dB	dBuV/m	dBuV/m	dB	
1	1289.73	32.74	24.79	3.51	41.86	19.18	50.00	-30.82 Average
2	1289.73	43.08	24.79	3.51	41.86	29.52	70.00	-40.48 Peak
3	1848.87	29.22	25.78	4.27	42.14	17.13	50.00	-32.87 Average
4	1848.87	41.66	25.78	4.27	42.14	29.57	70.00	-40.43 Peak
5	2717.74	29.21	27.91	5.61	41.96	20.77	50.00	-29.23 Average
6	2717.74	41.36	27.91	5.61	41.96	32.92	70.00	-37.08 Peak
7	3738.69	29.66	29.24	6.60	41.91	23.59	54.00	-30.41 Average
8	3738.69	41.52	29.24	6.60	41.91	35.45	74.00	-38.55 Peak
9	4408.69	29.86	30.44	7.64	41.71	26.23	54.00	-27.77 Average
10	4408.69	40.92	30.44	7.64	41.71	37.29	74.00	-36.71 Peak
11	5170.88	29.53	31.70	8.22	41.74	27.71	54.00	-26.29 Average
12	5170.88	40.42	31.70	8.22	41.74	38.60	74.00	-35.40 Peak

Note:Emission Level=Read Level+Antenna Factor+Cable loss-Preamp Factor



SGS-CSTC Standards Technical Services (Shanghai) Co., Ltd.

Report No.: SHEM180400277401
Page: 56 of 108

Mode:d; Polarization:Horizontal

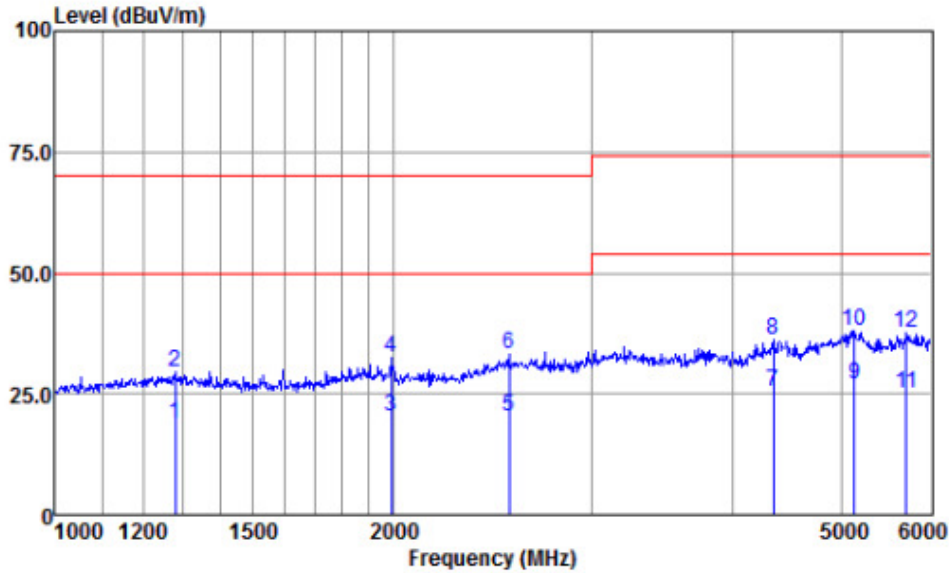

Antenna Polarity :HORIZONTAL
EUT/Project :2774IT
Test mode :d

	Read	Antenna	Cable	Preamp	Emission	Limit	Over	
Freq	Level	Factor	Loss	Factor	Level	Line	Limit	Remark
MHz	dBuv	dB/m	dB	dB	dBuv/m	dBuv/m	dB	
1	1278.22	32.38	24.77	3.51	41.86	18.80	50.00	-31.20 Average
2	1278.22	43.26	24.77	3.51	41.86	29.68	70.00	-40.32 Peak
3	1989.80	32.28	25.98	4.43	42.21	20.48	50.00	-29.52 Average
4	1989.80	44.11	25.98	4.43	42.21	32.31	70.00	-37.69 Peak
5	2534.31	29.47	27.49	5.37	42.13	20.20	50.00	-29.80 Average
6	2534.31	42.43	27.49	5.37	42.13	33.16	70.00	-36.84 Peak
7	4353.74	29.14	30.35	7.55	41.74	25.30	54.00	-28.70 Average
8	4353.74	40.04	30.35	7.55	41.74	36.20	74.00	-37.80 Peak
9	5143.16	28.66	31.69	8.22	41.73	26.84	54.00	-27.16 Average
10	5143.16	39.87	31.69	8.22	41.73	38.05	74.00	-35.95 Peak
11	5716.64	26.48	32.20	8.36	41.93	25.11	54.00	-28.89 Average
12	5716.64	38.94	32.20	8.36	41.93	37.57	74.00	-36.43 Peak

Note:Emission Level=Read Level+Antenna Factor+Cable loss-Preamp Factor



Mode:d; Polarization:Vertical

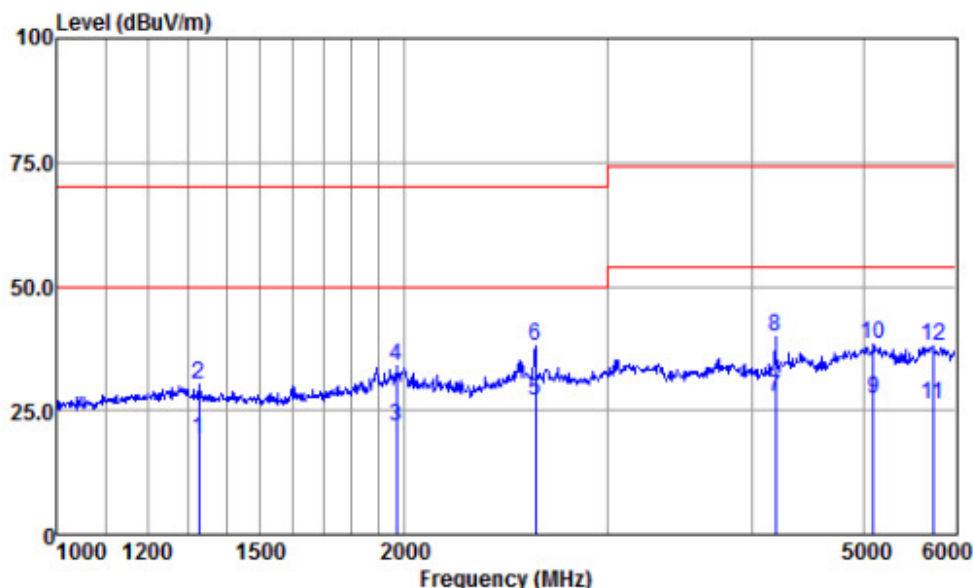

Antenna Polarity :VERTICAL
EUT/Project :2774IT
Test mode :d

	Read	Antenna	Cable	Preamp	Emission	Limit	Over	
Freq	Level	Factor	Loss	Factor	Level	Line	Limit	Remark
-----	-----	-----	-----	-----	-----	-----	-----	-----
MHz	dBuv	dB/m	dB	dB	dBuv/m	dBuv/m	dB	
1	1327.24	32.49	24.87	3.57	41.87	19.06	50.00	-30.94 Average
2	1327.24	43.73	24.87	3.57	41.87	30.30	70.00	-39.70 Peak
3	1968.53	33.52	25.95	4.39	42.20	21.66	50.00	-28.34 Average
4	1968.53	45.92	25.95	4.39	42.20	34.06	70.00	-35.94 Peak
5	2598.69	35.94	27.63	5.47	42.08	26.96	50.00	-23.04 Average
6	2598.69	47.16	27.63	5.47	42.08	38.18	70.00	-31.82 Peak
7	4200.48	32.08	30.08	7.39	41.83	27.72	54.00	-26.28 Average
8	4200.48	44.13	30.08	7.39	41.83	39.77	74.00	-34.23 Peak
9	5106.43	29.06	31.66	8.21	41.69	27.24	54.00	-26.76 Average
10	5106.43	40.24	31.66	8.21	41.69	38.42	74.00	-35.58 Peak
11	5747.46	27.63	32.25	8.36	41.92	26.32	54.00	-27.68 Average
12	5747.46	39.46	32.25	8.36	41.92	38.15	74.00	-35.85 Peak

Note:Emission Level=Read Level+Antenna Factor+Cable loss-Preamp Factor

Mode:e; Polarization:Horizontal

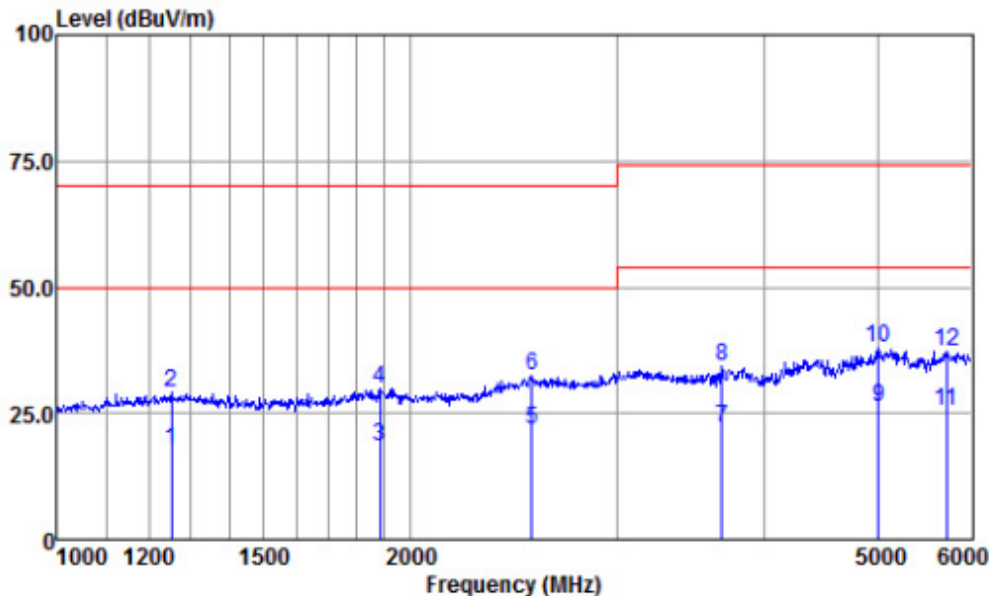

Antenna Polarity :HORIZONTAL
EUT/Project :2774IT
Test mode :e

	Read	Antenna	Cable	Preamp	Emission	Limit	Over	
Freq	Level	Factor	Loss	Factor	Level	Line	Limit	Remark
MHz	dBuv	dB/m	dB	dB	dBuv/m	dBuv/m	dB	
1	1251.03	31.54	24.70	3.45	41.84	17.85	50.00	-32.15 Average
2	1251.03	42.70	24.70	3.45	41.84	29.01	70.00	-40.99 Peak
3	1885.67	30.29	25.83	4.33	42.16	18.29	50.00	-31.71 Average
4	1885.67	41.74	25.83	4.33	42.16	29.74	70.00	-40.26 Peak
5	2538.86	30.87	27.49	5.37	42.13	21.60	50.00	-28.40 Average
6	2538.86	41.73	27.49	5.37	42.13	32.46	70.00	-37.54 Peak
7	3685.48	28.57	29.14	6.51	41.90	22.32	54.00	-31.68 Average
8	3685.48	40.70	29.14	6.51	41.90	34.45	74.00	-39.55 Peak
9	5006.77	28.09	31.60	8.19	41.61	26.27	54.00	-27.73 Average
10	5006.77	39.84	31.60	8.19	41.61	38.02	74.00	-35.98 Peak
11	5726.90	26.94	32.23	8.36	41.93	25.60	54.00	-28.40 Average
12	5726.90	38.63	32.23	8.36	41.93	37.29	74.00	-36.71 Peak

Note:Emission Level=Read Level+Antenna Factor+Cable loss-Preamp Factor

Mode:e; Polarization:Vertical

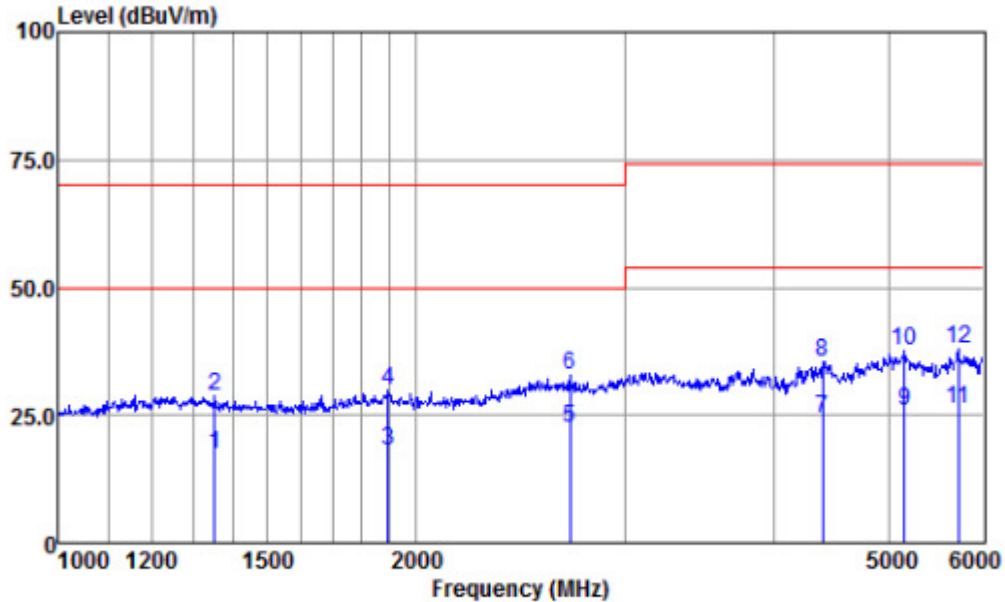

Antenna Polarity :VERTICAL
EUT/Project :2774IT
Test mode :e

	Read	Antenna	Cable	Preamp	Emission	Limit	Over	
Freq	Level	Factor	Loss	Factor	Level	Line	Limit	Remark
MHz	dBuv	dB/m	dB	dB	dBuv/m	dBuv/m	dB	
1	1353.65	30.66	24.93	3.66	41.88	17.37	50.00	-32.63 Average
2	1353.65	41.94	24.93	3.66	41.88	28.65	70.00	-41.35 Peak
3	1895.83	30.21	25.85	4.33	42.16	18.23	50.00	-31.77 Average
4	1895.83	41.76	25.85	4.33	42.16	29.78	70.00	-40.22 Peak
5	2698.33	30.96	27.85	5.57	41.98	22.40	50.00	-27.60 Average
6	2698.33	41.22	27.85	5.57	41.98	32.66	70.00	-37.34 Peak
7	4400.79	27.99	30.44	7.64	41.71	24.36	54.00	-29.64 Average
8	4400.79	39.12	30.44	7.64	41.71	35.49	74.00	-38.51 Peak
9	5161.63	27.67	31.70	8.22	41.74	25.85	54.00	-28.15 Average
10	5161.63	39.31	31.70	8.22	41.74	37.49	74.00	-36.51 Peak
11	5726.90	27.51	32.23	8.36	41.93	26.17	54.00	-27.83 Average
12	5726.90	39.32	32.23	8.36	41.93	37.98	74.00	-36.02 Peak

Note:Emission Level=Read Level+Antenna Factor+Cable loss-Preamp Factor



SGS-CSTC Standards Technical Services (Shanghai) Co., Ltd.

Report No.: SHEM180400277401
Page: 60 of 108

Mode:f; Polarization:Horizontal

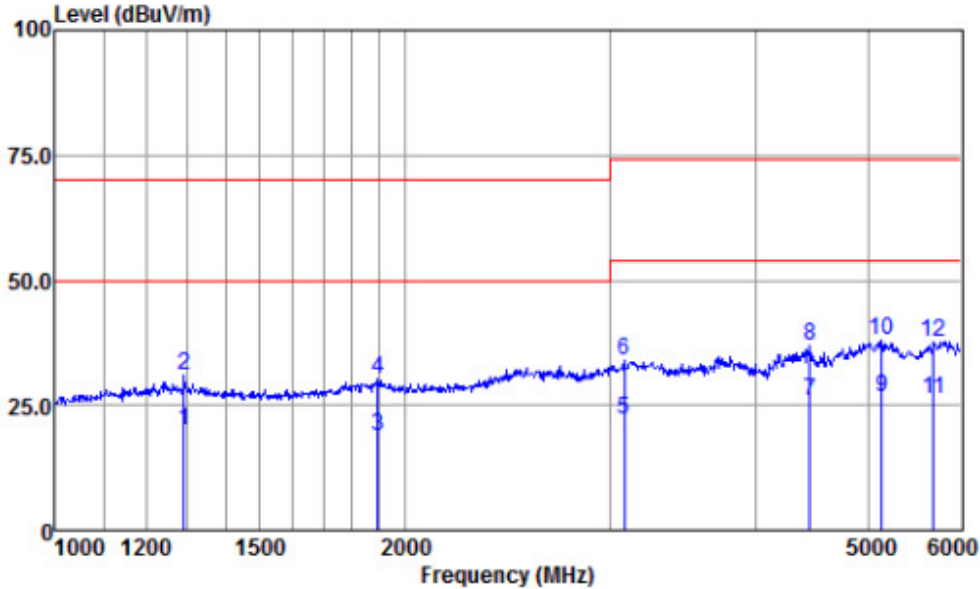

Antenna Polarity :HORIZONTAL
EUT/Project :2774IT
Test mode :f

	Read	Antenna	Cable	Preamp	Emission	Limit	Over		
Freq	Level	Factor	Loss	Factor	Level	Line	Limit	Remark	
-----	-----	-----	-----	-----	-----	-----	-----	-----	
MHz	dBuv	dB/m	dB	dB	dBuv/m	dBuv/m	dB		
1	1289.73	33.32	24.79	3.51	41.86	19.76	50.00	-30.24	Average
2	1289.73	44.39	24.79	3.51	41.86	30.83	70.00	-39.17	Peak
3	1895.83	30.97	25.85	4.33	42.16	18.99	50.00	-31.01	Average
4	1895.83	42.29	25.85	4.33	42.16	30.31	70.00	-39.69	Peak
5	3086.44	29.64	28.56	5.85	41.74	22.31	54.00	-31.69	Average
6	3086.44	41.35	28.56	5.85	41.74	34.02	74.00	-39.98	Peak
7	4456.34	29.38	30.53	7.70	41.68	25.93	54.00	-28.07	Average
8	4456.34	40.33	30.53	7.70	41.68	36.88	74.00	-37.12	Peak
9	5143.16	28.32	31.69	8.22	41.73	26.50	54.00	-27.50	Average
10	5143.16	39.83	31.69	8.22	41.73	38.01	74.00	-35.99	Peak
11	5696.20	27.62	32.18	8.36	41.94	26.22	54.00	-27.78	Average
12	5696.20	39.15	32.18	8.36	41.94	37.75	74.00	-36.25	Peak

Note:Emission Level=Read Level+Antenna Factor+Cable loss-Preamp Factor



SGS-CSTC Standards Technical Services (Shanghai) Co., Ltd.

Report No.: SHEM180400277401
Page: 61 of 108

Mode:f; Polarization:Vertical

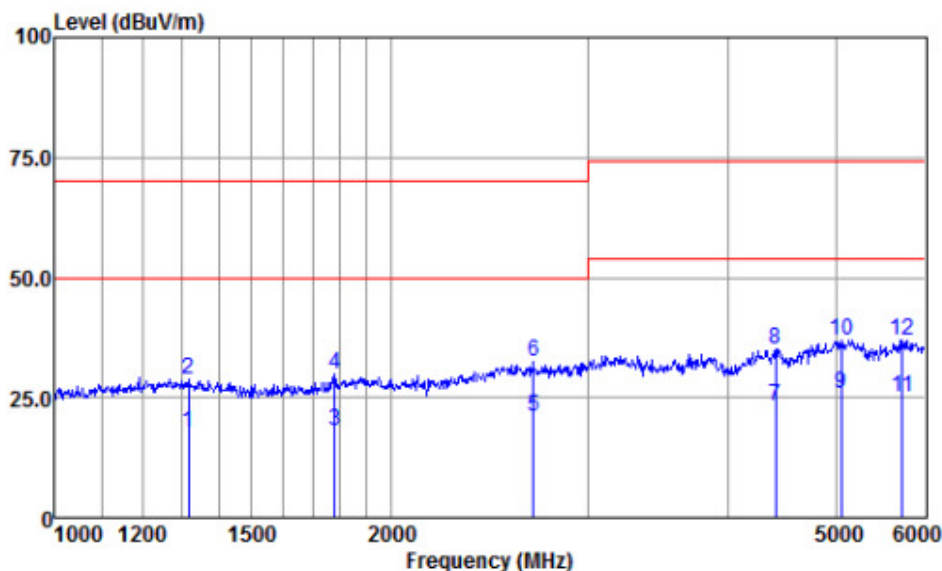

Antenna Polarity :VERTICAL
EUT/Project :2774IT
Test mode :f

	Read	Antenna	Cable	Preamp	Emission	Limit	Over	
Freq	Level	Factor	Loss	Factor	Level	Line	Limit	Remark
-----	-----	-----	-----	-----	-----	-----	-----	-----
MHz	dBuv	dB/m	dB	dB	dBuv/m	dBuv/m	dB	
1	1317.76	31.12	24.85	3.57	41.87	17.67	50.00	-32.33 Average
2	1317.76	42.39	24.85	3.57	41.87	28.94	70.00	-41.06 Peak
3	1780.59	30.40	25.68	4.21	42.10	18.19	50.00	-31.81 Average
4	1780.59	42.12	25.68	4.21	42.10	29.91	70.00	-40.09 Peak
5	2679.07	29.69	27.82	5.57	41.99	21.09	50.00	-28.91 Average
6	2679.07	41.02	27.82	5.57	41.99	32.42	70.00	-37.58 Peak
7	4416.59	26.97	30.47	7.64	41.70	23.38	54.00	-30.62 Average
8	4416.59	38.63	30.47	7.64	41.70	35.04	74.00	-38.96 Peak
9	5060.89	27.75	31.64	8.21	41.66	25.94	54.00	-28.06 Average
10	5060.89	38.85	31.64	8.21	41.66	37.04	74.00	-36.96 Peak
11	5737.17	26.26	32.23	8.36	41.93	24.92	54.00	-29.08 Average
12	5737.17	38.40	32.23	8.36	41.93	37.06	74.00	-36.94 Peak

Note:Emission Level=Read Level+Antenna Factor+Cable loss-Preamp Factor



6.5 Harmonic Current Emission

Test Requirement: EN 61000-3-2:2014

Test Method: EN 61000-3-2:2014

Frequency Range: 100Hz to 2kHz

There is no need for Harmonics test to be performed on this product (rated power is less than 75W) in accordance with EN 61000-3-2:2014.

For further details, please refer to Clause 7 of EN 61000-3-2 which states:

"For the following categories of equipment, limits are not specified in this standard.- equipment with a rated power of 75W or less, other than lighting equipment."

6.6 Voltage Fluctuations and Flicker

Test Requirement: EN 61000-3-3:2013

Test Method: EN 61000-3-3:2013

6.6.1 E.U.T. Operation

Operating Environment:

Temperature: 22 °C Humidity: 51 % RH Atmospheric Pressure: 1020 mbar

- Test mode:
- a: keep EUT previewing with DC12V support .
 - b: keep EUT previewing with PoE support .
 - c: keep DS-2CD2683G0-I previewing with DC12V support .
 - d: keep DS-2CD2683G0-I previewing with PoE support .
 - e: keep DS-2CD2663G0-I previewing with DC12V support .
 - f: keep DS-2CD2663G0-I previewing with PoE support .

6.6.2 Test Setup Diagram

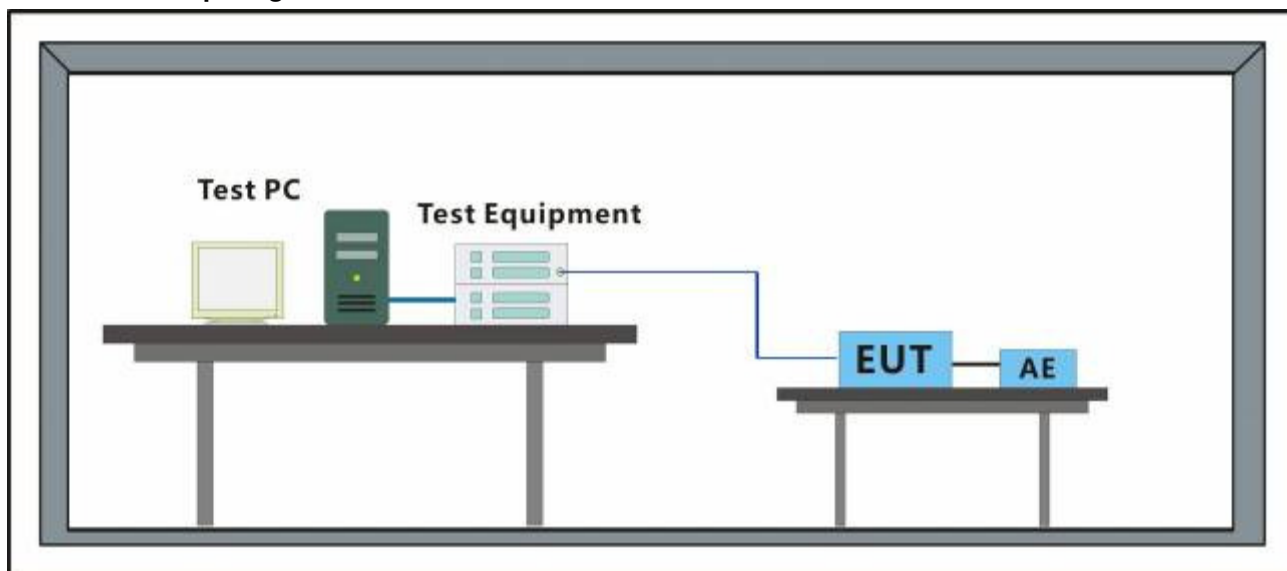

6.6.3 Measurement Data



SGS-CSTC Standards Technical Services (Shanghai) Co., Ltd.

Report No.: SHEM180400277401

Page: 64 of 108

For old model

Mode:a

Parameter values recorded during the test:

Vrms at the end of test (Volt):	229.86			
T-max (mS):	0	Test limit (mS):	500.0	Pass
Highest dc (%):	0.25	Test limit (%):	3.30	Pass
Highest dmax (%):	0.38	Test limit (%):	4.00	Pass
Highest Pst (10 min. period):	0.135	Test limit:	1.000	Pass
Highest Plt (2 hr. period):	0.080	Test limit:	0.650	Pass

Mode:b

Parameter values recorded during the test:

Vrms at the end of test (Volt):	229.86			
T-max (mS):	0	Test limit (mS):	500.0	Pass
Highest dc (%):	0.25	Test limit (%):	3.30	Pass
Highest dmax (%):	0.35	Test limit (%):	4.00	Pass
Highest Pst (10 min. period):	0.138	Test limit:	1.000	Pass
Highest Plt (2 hr. period):	0.089	Test limit:	0.650	Pass



SGS-CSTC Standards Technical Services (Shanghai) Co., Ltd.

Report No.: SHEM180400277401

Page: 65 of 108

For old model

Mode:c

Parameter values recorded during the test:

Vrms at the end of test (Volt):	229.87		
T-max (mS):	0	Test limit (mS):	500.0 Pass
Highest dc (%):	0.71	Test limit (%):	3.30 Pass
Highest dmax (%):	1.03	Test limit (%):	4.00 Pass
Highest Pst (10 min. period):	0.263	Test limit:	1.000 Pass
Highest Plt (2 hr. period):	0.126	Test limit:	0.650 Pass

Mode:d

Parameter values recorded during the test:

Vrms at the end of test (Volt):	229.87		
T-max (mS):	0	Test limit (mS):	500.0 Pass
Highest dc (%):	0.79	Test limit (%):	3.30 Pass
Highest dmax (%):	1.03	Test limit (%):	4.00 Pass
Highest Pst (10 min. period):	0.228	Test limit:	1.000 Pass
Highest Plt (2 hr. period):	0.125	Test limit:	0.650 Pass

Mode:e

Parameter values recorded during the test:

Vrms at the end of test (Volt):	229.87		
T-max (mS):	0	Test limit (mS):	500.0 Pass
Highest dc (%):	0.73	Test limit (%):	3.30 Pass
Highest dmax (%):	1.10	Test limit (%):	4.00 Pass
Highest Pst (10 min. period):	0.252	Test limit:	1.000 Pass
Highest Plt (2 hr. period):	0.121	Test limit:	0.650 Pass

Mode:f

Parameter values recorded during the test:

Vrms at the end of test (Volt):	229.87		
T-max (mS):	0	Test limit (mS):	500.0 Pass
Highest dc (%):	0.69	Test limit (%):	3.30 Pass
Highest dmax (%):	1.08	Test limit (%):	4.00 Pass
Highest Pst (10 min. period):	0.223	Test limit:	1.000 Pass
Highest Plt (2 hr. period):	0.118	Test limit:	0.650 Pass



7 Immunity Test Results

7.1 Performance Criteria Description in EN 50130-4:2011 +A1:2014

There shall be no damage, malfunction or change of status due to the conditioning. Flickering of an indicator during the application of the discharges is permissible, providing that there is no residual change in the EUT or any change in outputs, which could be interpreted by associated equipment as a change.

For further details, please refer to Clause 7.4, 8.4, 9.4, 10.4, 11.4, 12.4 and 13.4, of EN 50130-4.

7.2 Electrostatic Discharge

Test Requirement: EN 50130-4:2011 +A1:2014
 Test Method: EN 61000-4-2:2009
 Number of Discharge: Minimum 10 times at each test point for Air Discharge
 Minimum 50 times at each test point for Contact or VCP & HCP Discharge
 Discharge Mode: Single Discharge
 Discharge Period: 1 second minimum

7.2.1 Test Setup Diagram

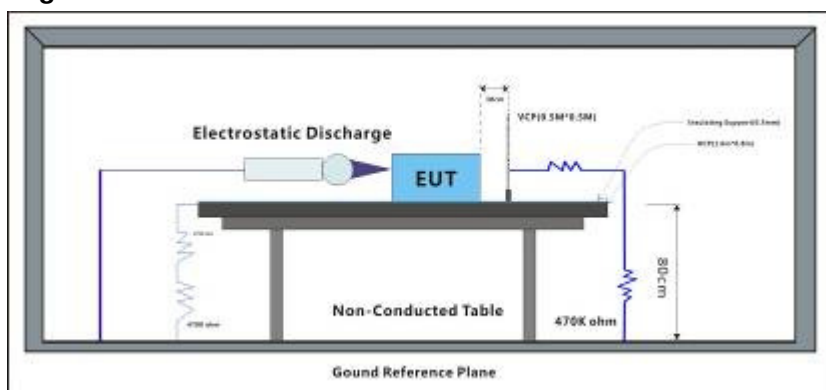

7.2.2 E.U.T. Operation

Operating Environment:
 Temperature: 22 °C Humidity: 48 % RH Atmospheric Pressure: 1010 mbar
 Test mode:
 a: keep EUT previewing with DC12V support .
 b: keep EUT previewing with PoE support .
 c: keep DS-2CD2683G0-I previewing with DC12V support .
 d: keep DS-2CD2683G0-I previewing with PoE support .
 e: keep DS-2CD2663G0-I previewing with DC12V support .
 f: keep DS-2CD2663G0-I previewing with PoE support .

7.2.3 Test Results:

Observations: Test Point:
 1. All insulated enclosure and seams.
 2. All accessible metal parts of the enclosure.
 3. All side

Discharge type	Level (kV)	Polarity	Test Point	Result / Observations
Air Discharge	2,4,8	+	1	A
Air Discharge	2,4,8	-	1	A
Contact Discharge	6	+	2	A
Contact Discharge	6	-	2	A
Horizontal Coupling	6	+	3	A
Horizontal Coupling	6	-	3	A
Vertical Coupling	6	+	3	A
Vertical Coupling	6	-	3	A

Results:

A: No degradation in the performance of the EUT was observed.

7.3 Electrical Fast Transients/Burst at Power Port

Test Requirement: EN 50130-4:2011 +A1:2014
 Test Method: EN 61000-4-4:2012
 Repetition Frequency: 100kHz
 Burst Period: 300ms
 Test Duration: 1 minute per level & polarity

7.3.1 Test Setup Diagram

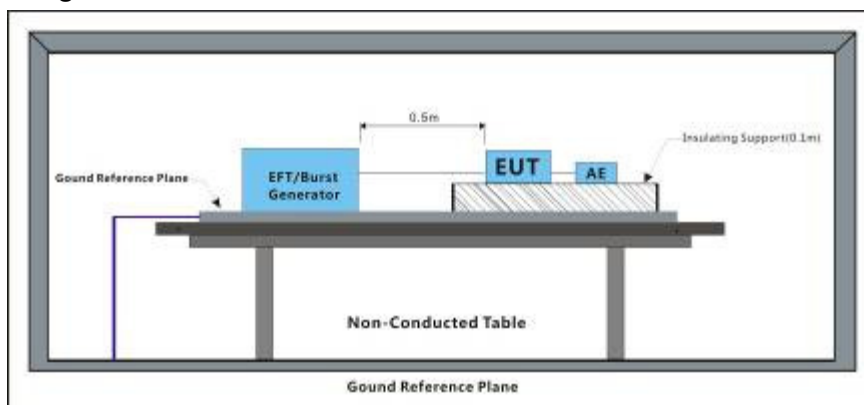

7.3.2 E.U.T. Operation

Operating Environment:

Temperature: 22 °C Humidity: 48 % RH Atmospheric Pressure: 1010 mbar

- Test mode:
- a: keep EUT previewing with DC12V support .
 - b: keep EUT previewing with PoE support .
 - c: keep DS-2CD2683G0-I previewing with DC12V support .
 - d: keep DS-2CD2683G0-I previewing with PoE support .
 - e: keep DS-2CD2663G0-I previewing with DC12V support .
 - f: keep DS-2CD2663G0-I previewing with PoE support .

7.3.3 Test Results:

Test Line	Level (kV)	Polarity	CDN/Clamp	Result / Observations
AC power port	2	+	CDN	A
AC power port	2	-	CDN	A

Results:

A: No degradation in the performance of the EUT was observed.

7.4 Electrical Fast Transients/Burst at Signal Port

Test Requirement: EN 50130-4:2011 +A1:2014
 Test Method: EN 61000-4-4:2012
 Repetition Frequency: 100kHz
 Burst Period: 300ms
 Test Duration: 1 minute per level & polarity

7.4.1 Test Setup Diagram

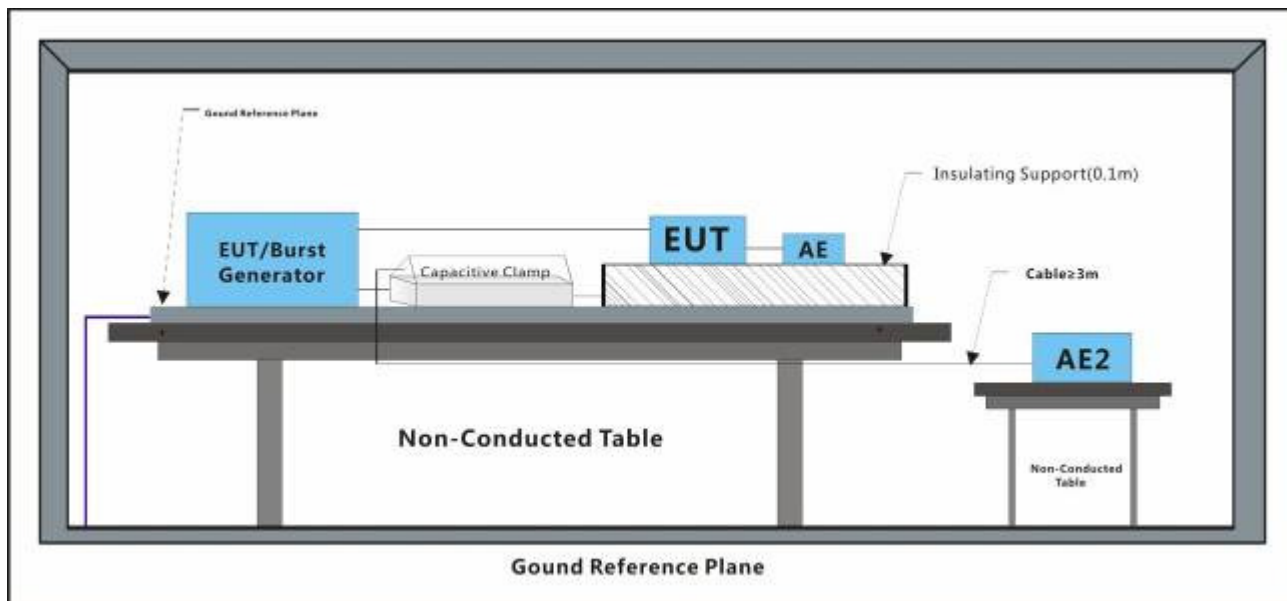

7.4.2 E.U.T. Operation

Operating Environment:
 Temperature: 22 °C Humidity: 48 % RH Atmospheric Pressure: 1010 mbar
 Test mode:
 a: keep EUT previewing with DC12V support .
 b: keep EUT previewing with PoE support .
 c: keep DS-2CD2683G0-I previewing with DC12V support .
 d: keep DS-2CD2683G0-I previewing with PoE support .
 e: keep DS-2CD2663G0-I previewing with DC12V support .
 f: keep DS-2CD2663G0-I previewing with PoE support .

7.4.3 Test Results:

Port	Level (kV)	Polarity	CDN/Clamp	Result / Observations
Signal port	1	+	Clamp	A
Signal port	1	-	Clamp	A

Results:

A: No degradation in the performance of the EUT was observed.

7.5 Surge at Power Port

Test Requirement: EN 50130-4:2011 +A1:2014
 Test Method: EN 61000-4-5:2014
 Interval: 60s between each surge
 No. of surges: 5 positive, 5 negative

7.5.1 Test Setup Diagram

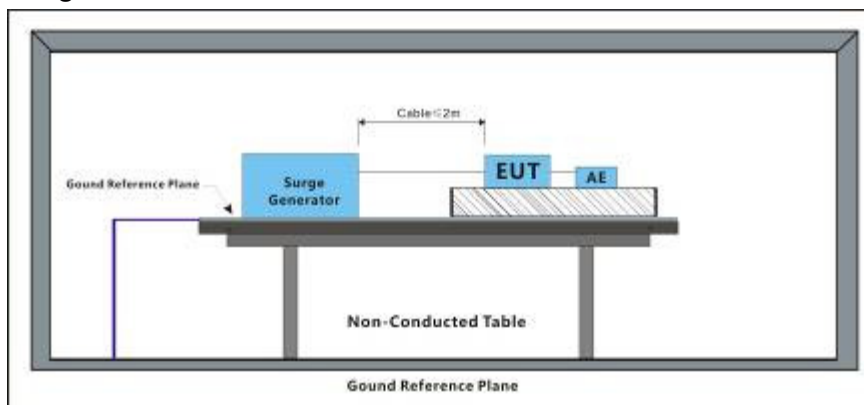

7.5.2 E.U.T. Operation

Operating Environment:

Temperature: 22 °C Humidity: 48 % RH Atmospheric Pressure: 1010 mbar

- Test mode:
- a: keep EUT previewing with DC12V support .
 - b: keep EUT previewing with PoE support .
 - c: keep DS-2CD2683G0-I previewing with DC12V support .
 - d: keep DS-2CD2683G0-I previewing with PoE support .
 - e: keep DS-2CD2663G0-I previewing with DC12V support .
 - f: keep DS-2CD2663G0-I previewing with PoE support .

7.5.3 Test Results:

Test Line	Level (kV)	Polarity	Phase (deg)	Result / Observations
L-N	0.5,1	+	0°	A
L-N	0.5,1	-	0°	A
L-N	0.5,1	+	90°	A
L-N	0.5,1	-	90°	A
L-N	0.5,1	+	180°	A
L-N	0.5,1	-	180°	A
L-N	0.5,1	+	270°	A
L-N	0.5,1	-	270°	A
L-PE	0.5,1,2	+	0°	A
L-PE	0.5,1,2	-	0°	A
L-PE	0.5,1,2	+	90°	A
L-PE	0.5,1,2	-	90°	A
L-PE	0.5,1,2	+	180°	A
L-PE	0.5,1,2	-	180°	A
L-PE	0.5,1,2	+	270°	A
L-PE	0.5,1,2	-	270°	A



SGS-CSTC Standards Technical Services (Shanghai) Co., Ltd.

Report No.: SHEM180400277401

Page: 71 of 108

N-PE	0.5,1,2	+	0°	A
N-PE	0.5,1,2	-	0°	A
N-PE	0.5,1,2	+	90°	A
N-PE	0.5,1,2	-	90°	A
N-PE	0.5,1,2	+	180°	A
N-PE	0.5,1,2	-	180°	A
N-PE	0.5,1,2	+	270°	A
N-PE	0.5,1,2	-	270°	A

Results:

A: No degradation in the performance of the EUT was observed.

7.6 Surge at Signal Port

Test Requirement: EN 50130-4:2011 +A1:2014
Test Method: EN 61000-4-5:2014

7.6.1 Test Setup Diagram

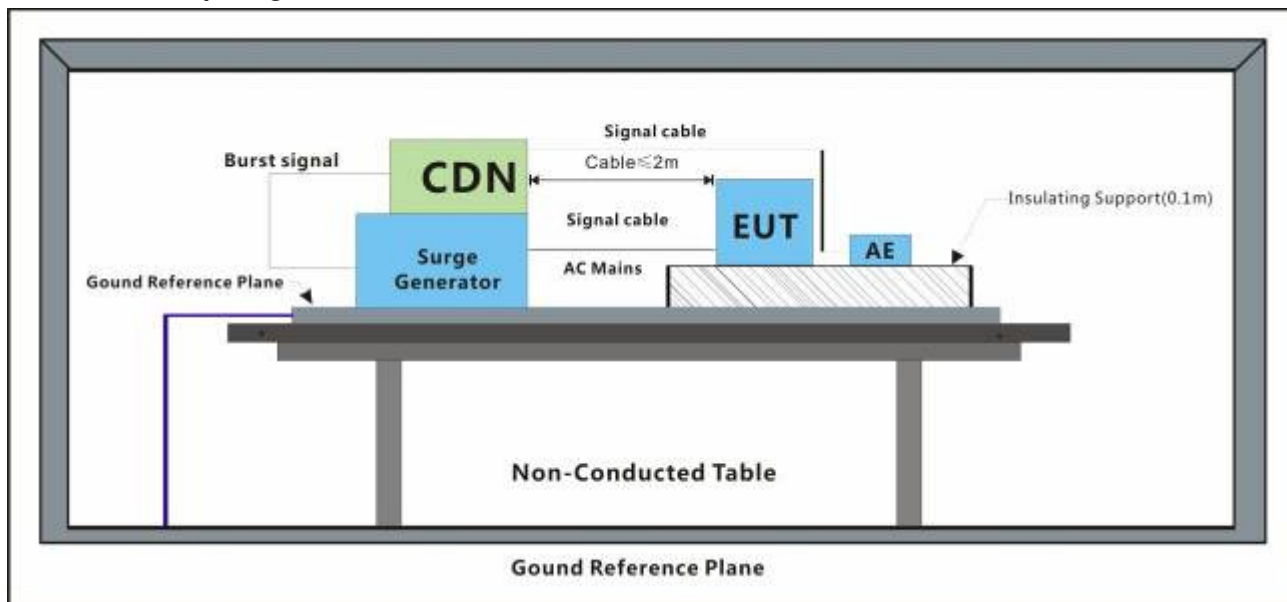

7.6.2 E.U.T. Operation

Operating Environment:

Temperature: 22 °C Humidity: 48 % RH Atmospheric Pressure: 1010 mbar

- Test mode:
- a: keep EUT previewing with DC12V support .
 - b: keep EUT previewing with PoE support .
 - c: keep DS-2CD2683G0-I previewing with DC12V support .
 - d: keep DS-2CD2683G0-I previewing with PoE support .
 - e: keep DS-2CD2663G0-I previewing with DC12V support .
 - f: keep DS-2CD2663G0-I previewing with PoE support .

7.6.3 Test Results:

Port	Line	Level (kV)	Polarity	Result / Observations
Signal port	Line-Ground	0.5	+	A
Signal port	Line-Ground	0.5	-	A
Signal port	Line-Ground	1	+	A
Signal port	Line-Ground	1	-	A

Results:

A: No degradation in the performance of the EUT was observed.

7.7 Voltage Dips and Interruptions

Test Requirement: EN 50130-4:2011 +A1:2014
 Test Method: EN 61000-4-11:2004
 Performance Criterion: 0% of UT (Supply Voltage) for 250 Periods; 40% of UT for 10 Periods; 70% of UT for 25 Periods; 80% of UT for 250 Periods;
 No. of Dips / Interruptions: 3 per Level
 Time between dropout 10s

7.7.1 Test Setup Diagram

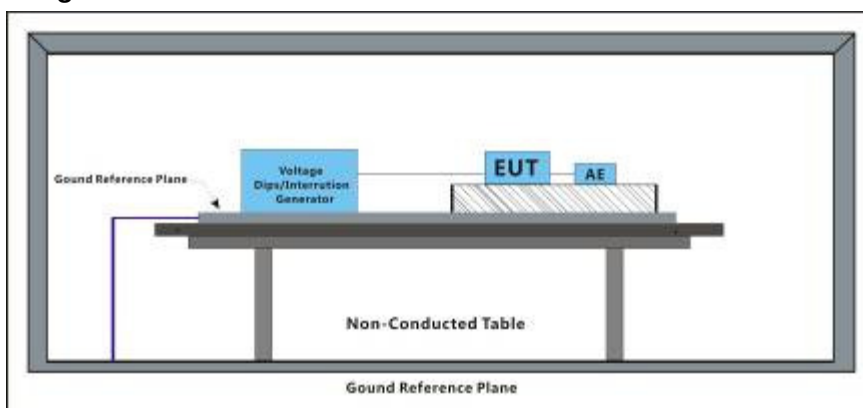

7.7.2 E.U.T. Operation

Operating Environment:

Temperature: 22 °C Humidity: 48 % RH Atmospheric Pressure: 1010 mbar

Test mode:

- a: keep EUT previewing with DC12V support .
- b: keep EUT previewing with PoE support .
- c: keep DS-2CD2683G0-I previewing with DC12V support .
- d: keep DS-2CD2683G0-I previewing with PoE support .
- e: keep DS-2CD2663G0-I previewing with DC12V support .
- f: keep DS-2CD2663G0-I previewing with PoE support .

7.7.3 Test Results:

Level % UT	Phase (deg)	Duration	No. of Dips / Interruptions	Result / Observations
80	0°	250 Cycles	3	A
80	180°	250 Cycles	3	A
70	0°	25 Cycles	3	A
70	180°	25 Cycles	3	A
40	0°	10 Cycles	3	A
40	180°	10 Cycles	3	A
0	0°	250 Cycles	3	B
0	180°	250 Cycles	3	B

Results:

A: No degradation in the performance of the EUT was observed.

B: During test, the EUT restarted automatically

7.8 Mains Supply Voltage Variations-Conditioning

Test Requirement:	EN 50130-4:2011 +A1:2014
Test Method:	EN 50130-4:2011+A1:2014
Voltage max.:	AC 253V (Umax: Unom + 10%)
Voltage min.:	AC 195.55V (Umin: Unom - 15%)
Unom Voltage:	AC 230V

7.8.1 Test Setup Diagram

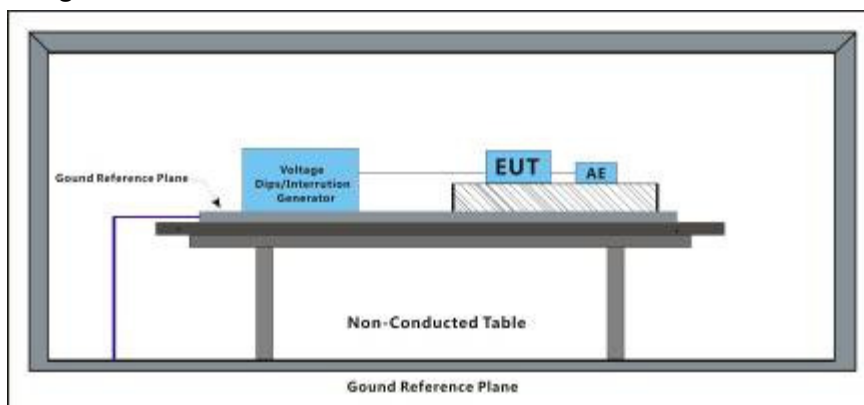

7.8.2 E.U.T. Operation

Operating Environment:

Temperature: 22 °C Humidity: 48 % RH Atmospheric Pressure: 1010 mbar

- Test mode:
- a: keep EUT previewing with DC12V support .
 - b: keep EUT previewing with PoE support .
 - c: keep DS-2CD2683G0-I previewing with DC12V support .
 - d: keep DS-2CD2683G0-I previewing with PoE support .
 - e: keep DS-2CD2663G0-I previewing with DC12V support .
 - f: keep DS-2CD2663G0-I previewing with PoE support .

7.8.3 Test Results:

Test phenomenon description for the EUT:

1. The EUT working normal, before the conditioning.
2. Monitor the EUT during the conditioning period and detected no any changes in states, during the conditioning.
3. No degradation in the performance of the EUT was observed, after the conditioning.

7.9 Radiated Immunity(80MHz-2.7GHz)

Test Requirement: EN 50130-4:2011 +A1:2014
 Test Method: EN 61000-4-3:2006 +A1:2008+A2:2010
 Modulation: 80%, 1 kHz Amplitude Modulation & 0.5s ON 0.5s OFF Pulse Modulation

7.9.1 Test Setup Diagram

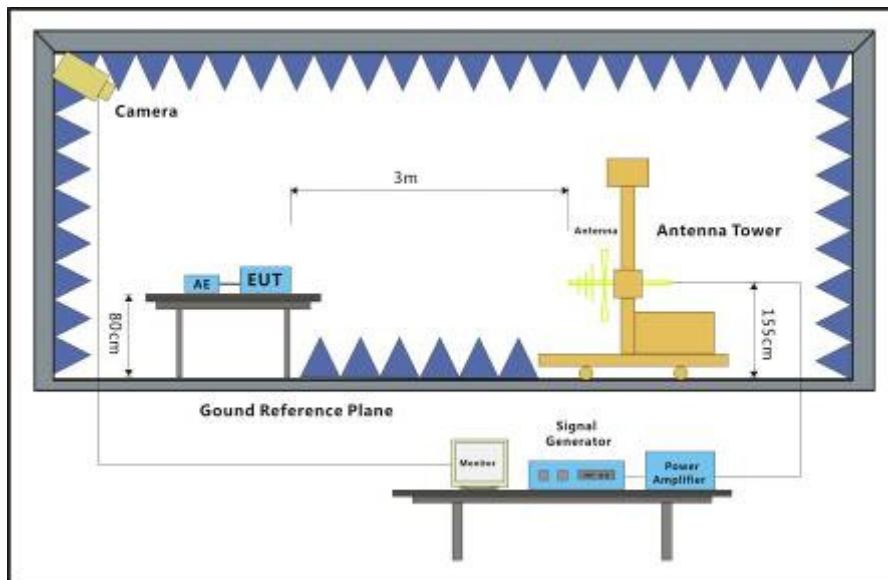

7.9.2 E.U.T. Operation

Operating Environment:
 Temperature: 22 °C Humidity: 50 % RH Atmospheric Pressure: 1020 mbar
 Test mode:
 a: keep EUT previewing with DC12V support .
 b: keep EUT previewing with PoE support .
 c: keep DS-2CD2683G0-I previewing with DC12V support .
 d: keep DS-2CD2683G0-I previewing with PoE support .
 e: keep DS-2CD2663G0-I previewing with DC12V support .
 f: keep DS-2CD2663G0-I previewing with PoE support .

7.9.3 Test Results:

Frequency	Level (V/m)	EUT Face	Dwell time	Result / Observations
80MHz-2.7GHz	10	Front	3s	A
80MHz-2.7GHz	10	Back	3s	A
80MHz-2.7GHz	10	Left	3s	A
80MHz-2.7GHz	10	Right	3s	A
80MHz-2.7GHz	10	Top	3s	A
80MHz-2.7GHz	10	Underside	3s	A

Results:

A: No degradation in the performance of the EUT was observed.

7.10 Conducted Immunity at Power Port (150kHz-100MHz)

Test Requirement: EN 50130-4:2011 +A1:2014
 Test Method: EN 61000-4-6:2014
 Modulation: 80%, 1 kHz Amplitude Modulation & 0.5s ON 0.5s OFF Pulse Modulation

7.10.1 Test Setup Diagram

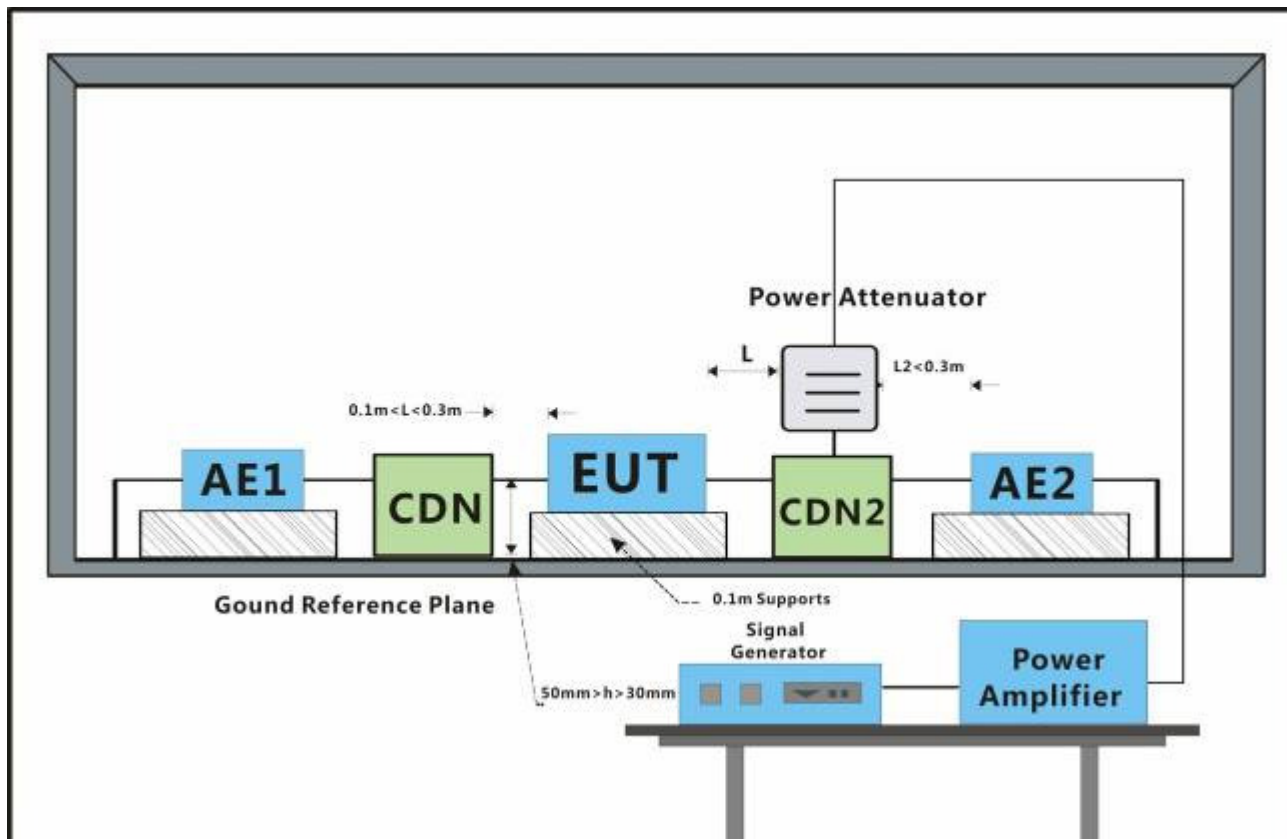

7.10.2 E.U.T. Operation

Operating Environment:
 Temperature: 22 °C Humidity: 50 % RH Atmospheric Pressure: 1002 mbar
 Test mode:
 a: keep EUT previewing with DC12V support .
 b: keep EUT previewing with PoE support .
 c: keep DS-2CD2683G0-I previewing with DC12V support .
 d: keep DS-2CD2683G0-I previewing with PoE support .
 e: keep DS-2CD2663G0-I previewing with DC12V support .
 f: keep DS-2CD2663G0-I previewing with PoE support .

7.10.3 Test Results:

Cable port	Level (Vrms)	CDN/Clamp	Dwell time	Result / Observations
AC power port	10	CDN	3s	A

Results:

A: No degradation in the performance of the EUT was observed.

7.11 Conducted Immunity at Signal Port (150kHz-100MHz)

Test Requirement: EN 50130-4:2011 +A1:2014
 Test Method: EN 61000-4-6:2014
 Modulation: 80%, 1 kHz Amplitude Modulation & 0.5s ON 0.5s OFF Pulse Modulation

7.11.1 Test Setup Diagram

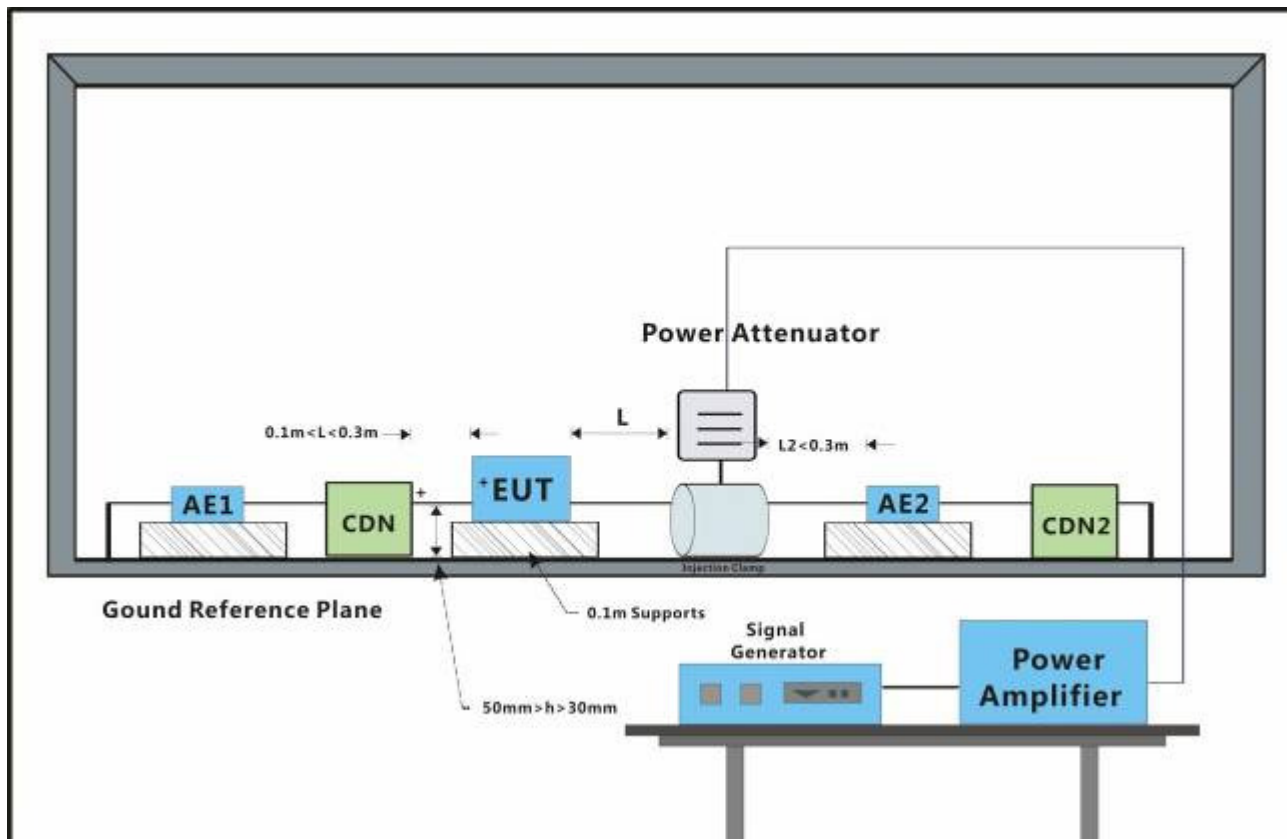

7.11.2 E.U.T. Operation

Operating Environment:
 Temperature: 22 °C Humidity: 50 % RH Atmospheric Pressure: 1002 mbar
 Test mode:
 a: keep EUT previewing with DC12V support .
 b: keep EUT previewing with PoE support .
 c: keep DS-2CD2683G0-I previewing with DC12V support .
 d: keep DS-2CD2683G0-I previewing with PoE support .
 e: keep DS-2CD2663G0-I previewing with DC12V support .
 f: keep DS-2CD2663G0-I previewing with PoE support .

7.11.3 Test Results:

Port	Level (Vrms)	CDN/Clamp	Dwell time	Result / Observations
Signal port	10	Coupling	3s	B

Results:

A: No degradation in the performance of the EUT was observed.
 B: .At 10 V/m, Display has wave shake from 310KHz to 10.27MHz that the system could still be used

8 Photographs

8.1 Conducted Emissions at Mains Terminals (150kHz-30MHz) Test Setup



8.2 Asymmetric Mode Conducted Emissions (150kHz-30MHz) Test Setup



8.3 Radiated Emissions (30MHz-1GHz) Test Setup



8.4 Radiated Emissions (above 1GHz) Test Setup



8.5 Voltage Fluctuations and Flicker Test Setup

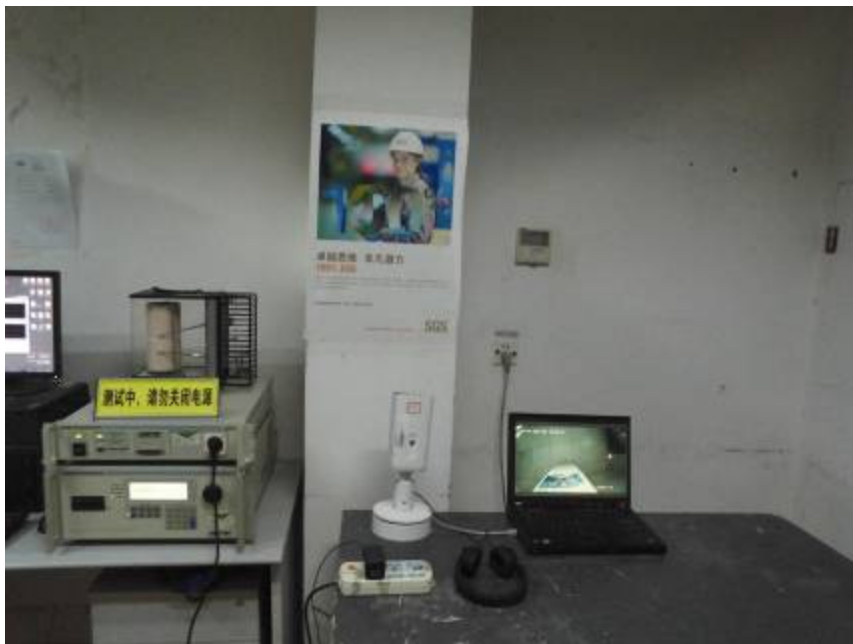

8.6 Electrostatic Discharge Test Setup



8.7 Electrical Fast Transients/Burst at Power Port Test Setup



8.8 Electrical Fast Transients/Burst at Signal Port Test Setup



8.9 Surge at Power Port Test Setup



8.10 Surge at Signal Port Test Setup



8.11 Voltage Dips and Interruptions Test Setup



8.12 Mains Supply Voltage Variations-Conditioning Test Setup



8.13 Radiated Immunity(80MHz-2.7GHz) Test Setup

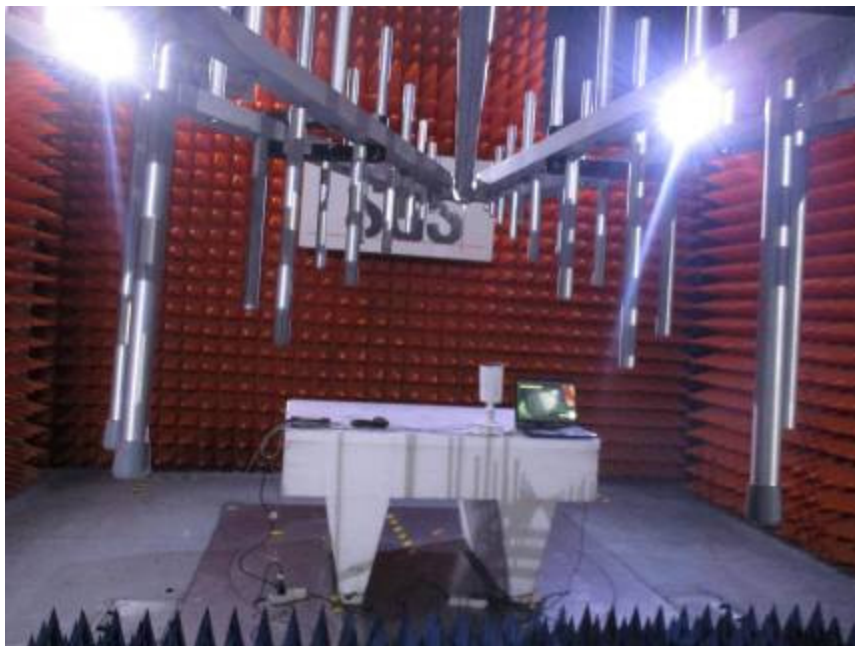

8.14 Conducted Immunity at Power Port (150kHz-100MHz) Test Setup

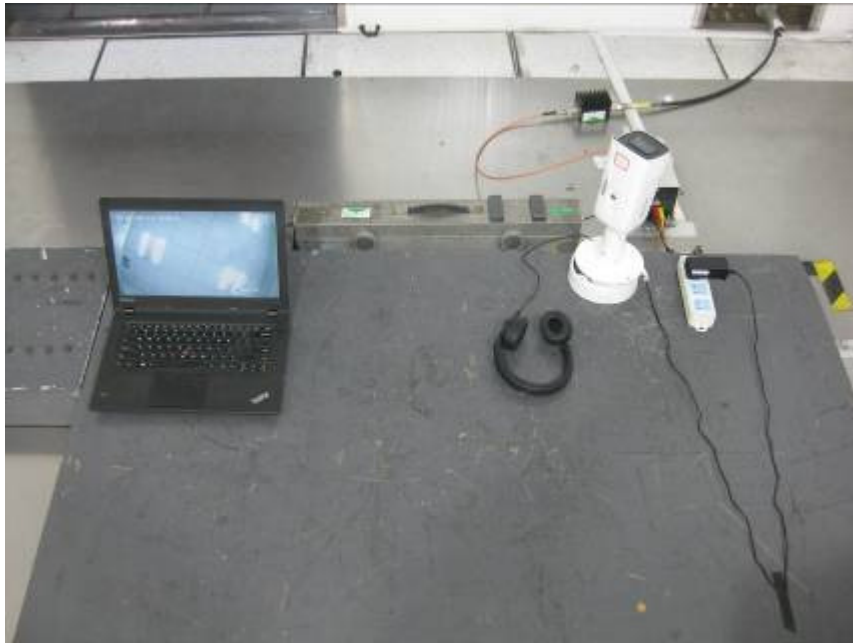

8.15 Conducted Immunity at Signal Port (150kHz-100MHz) Test Setup

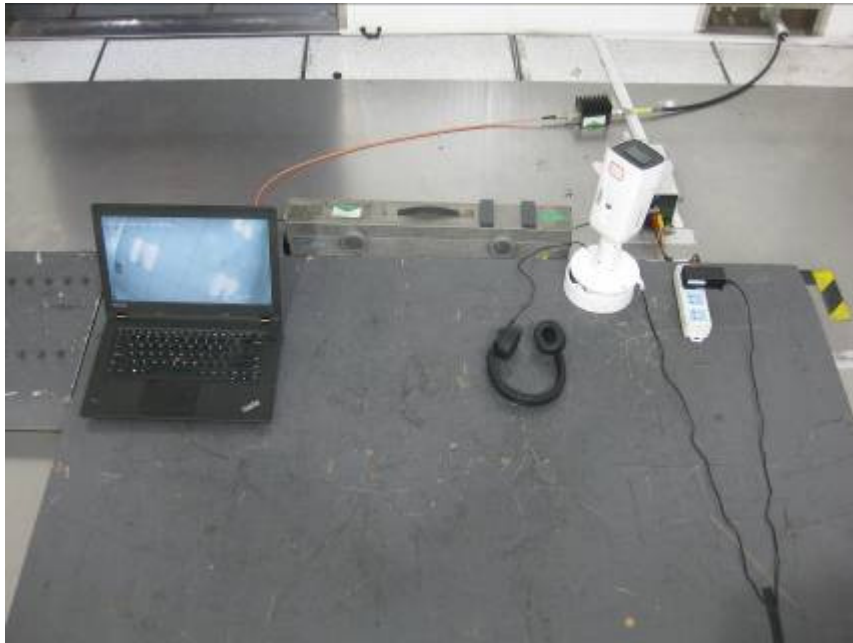

8.16 EUT Constructional Details

For old model







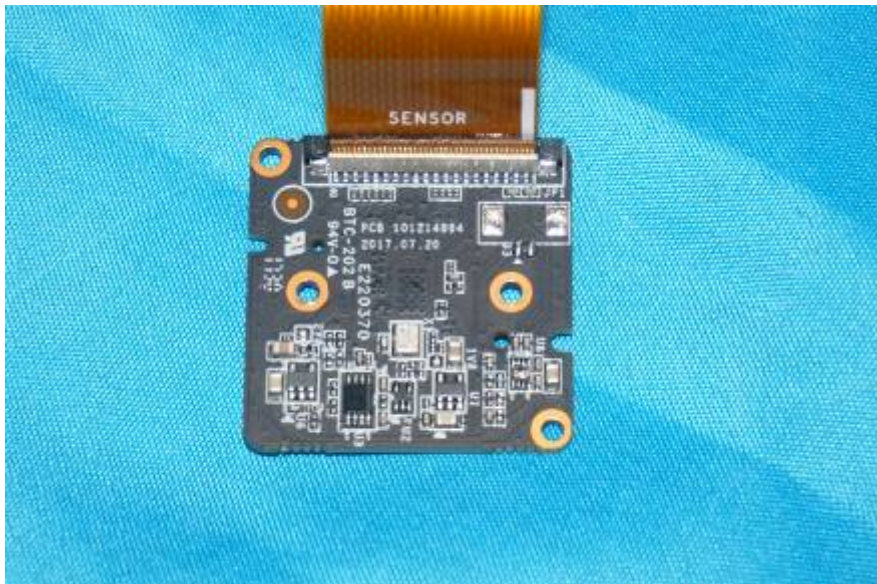

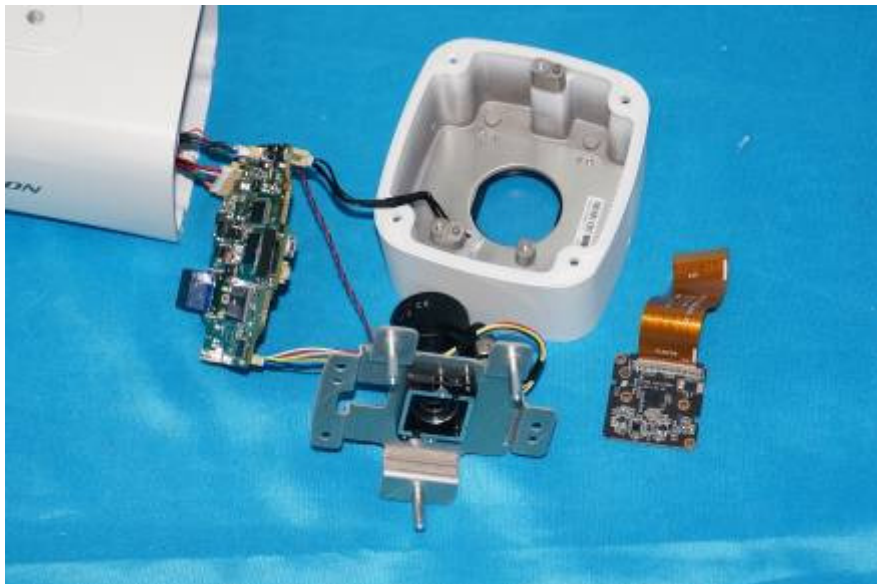
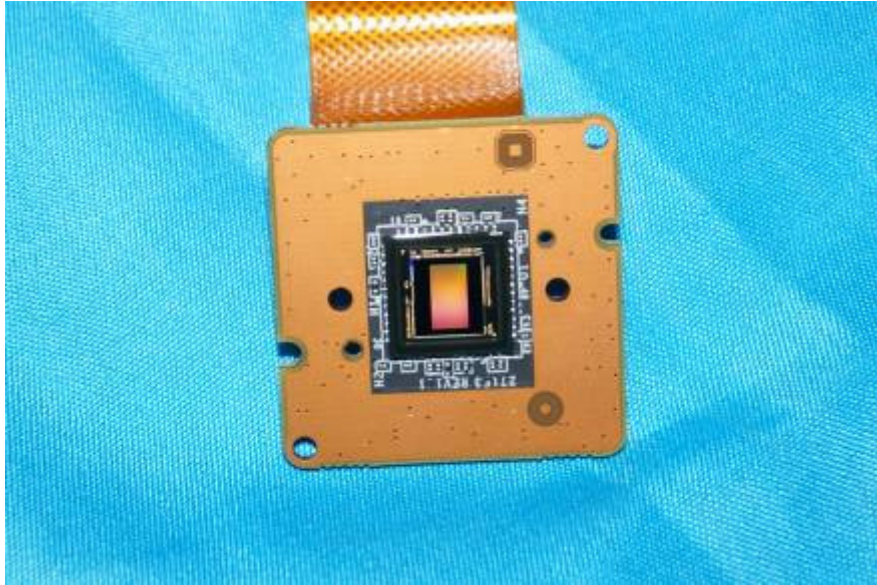



For new models



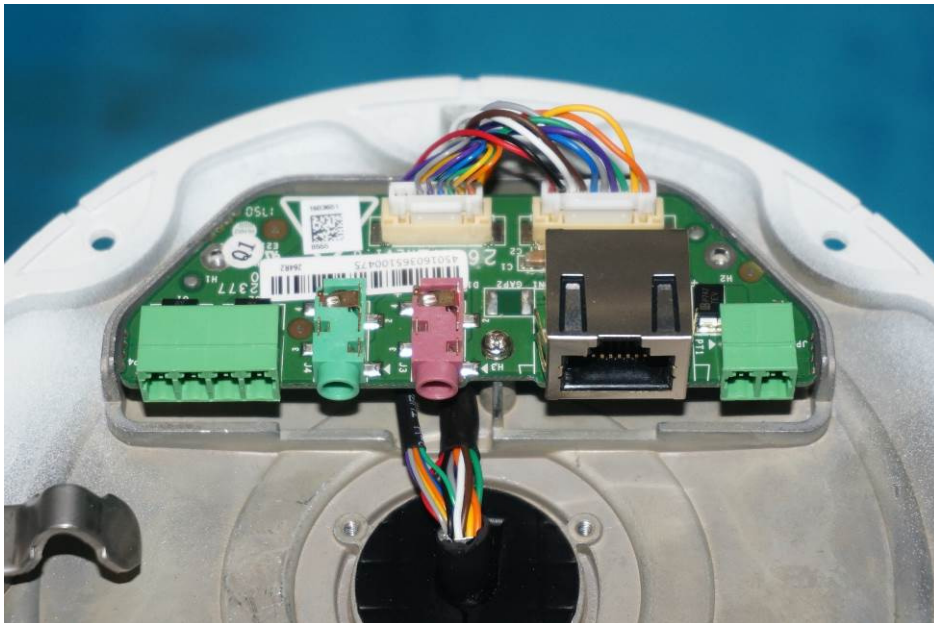

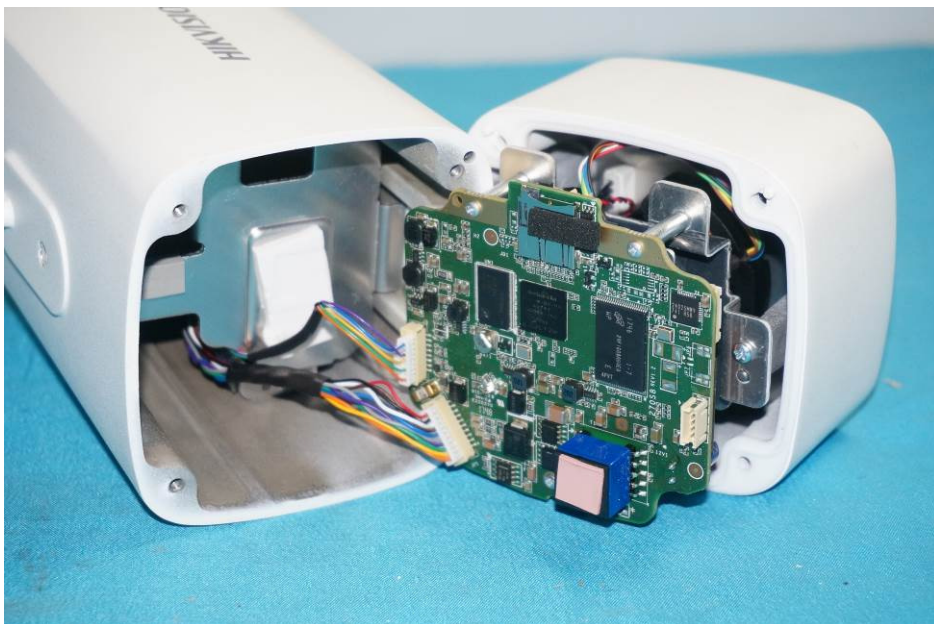

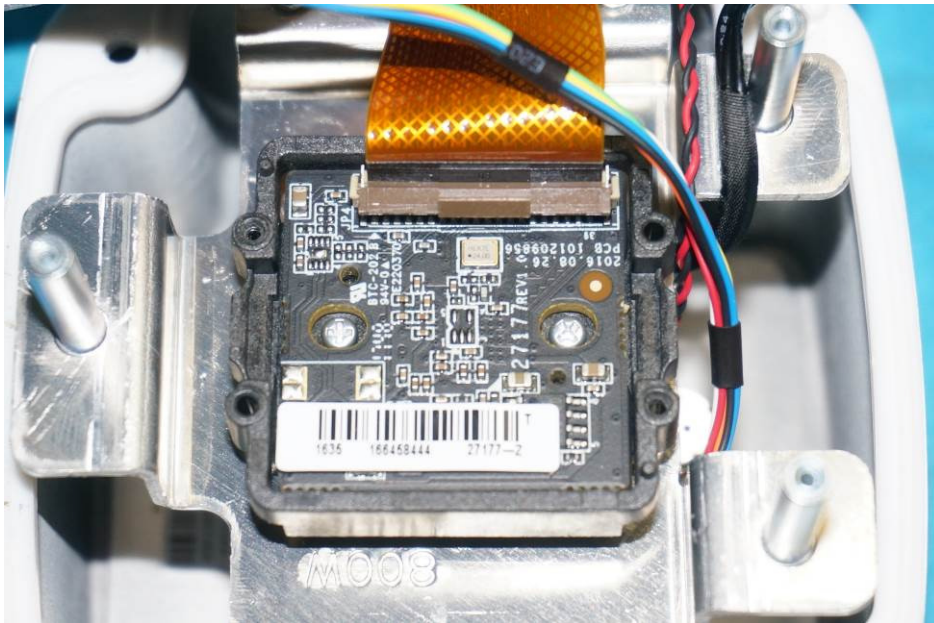

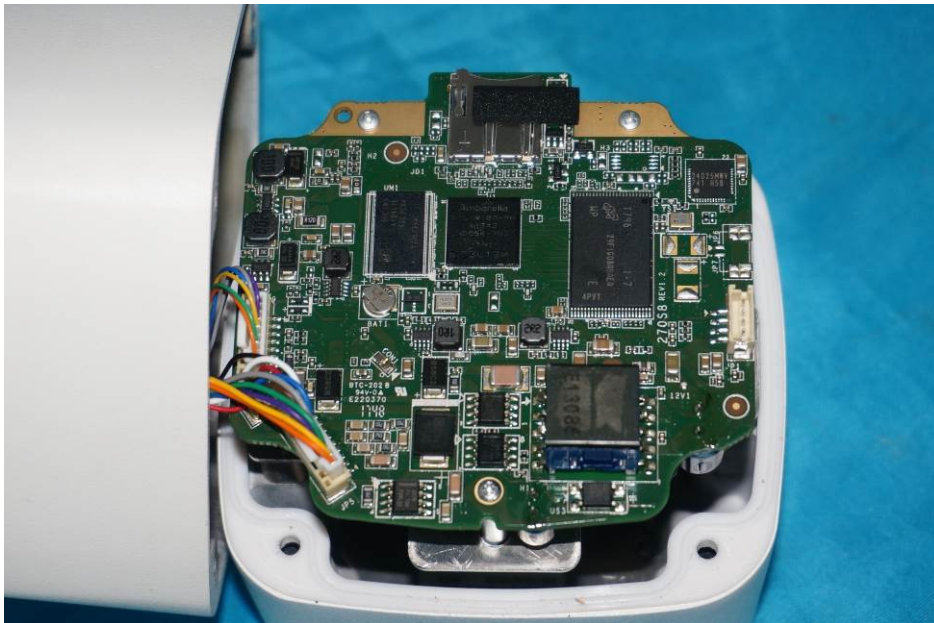
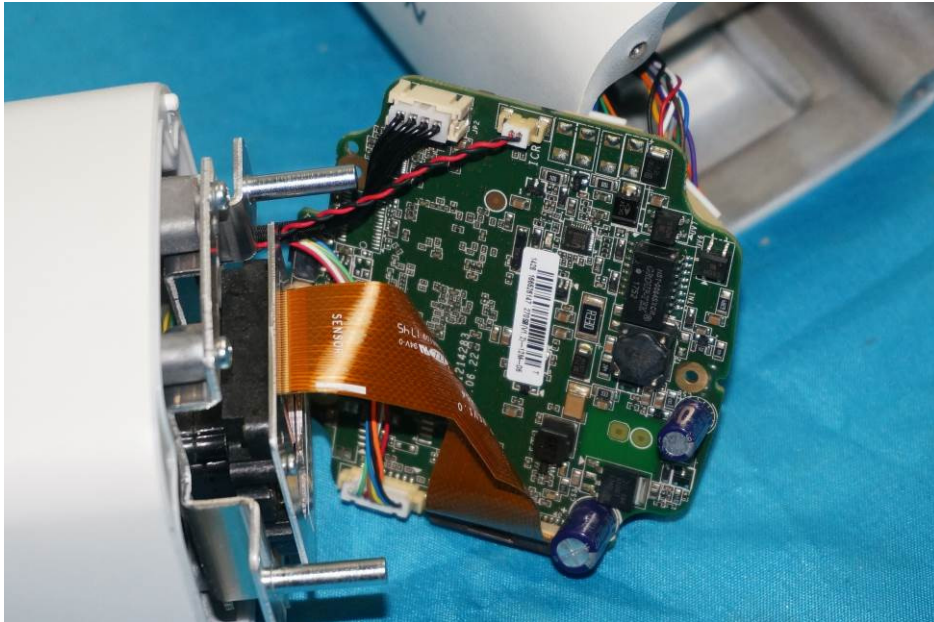



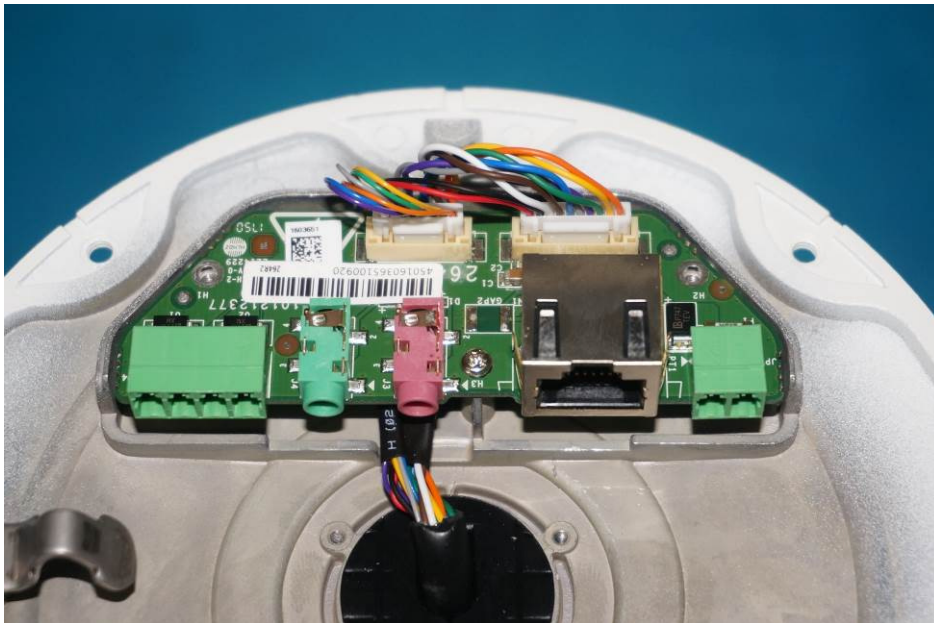



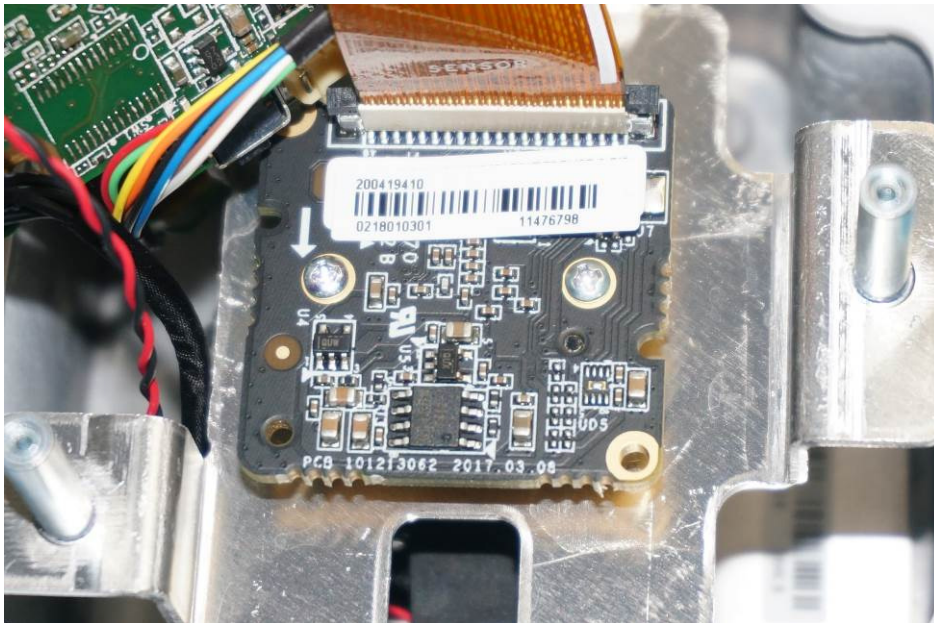
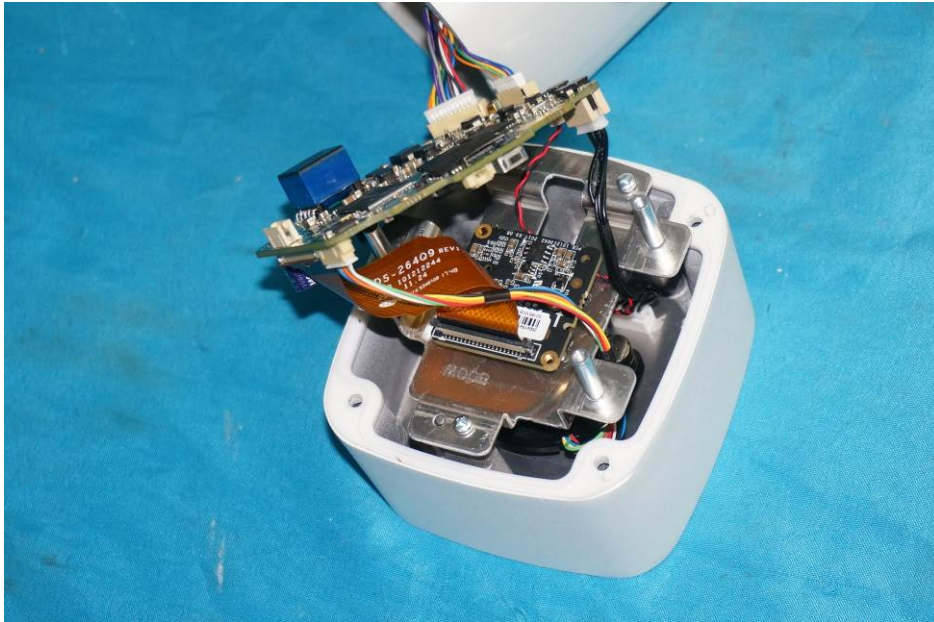

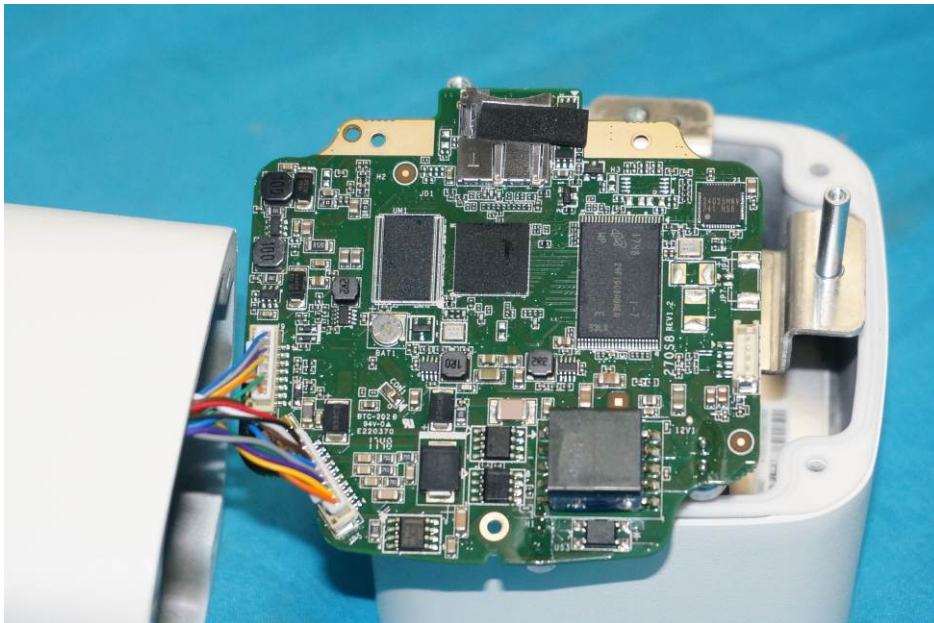

--End of the Report--